

Rosemount™ 499ACL-03

Monochloramine Sensor



Safety information

⚠ CAUTION

Sensor/process application compatibility

The wetted sensor materials may not be compatible with process composition and operating conditions.

Application compatibility is entirely the operator's responsibility.

⚠ CAUTION

Equipment damage

Do not exceed pressure and temperature specifications

Pressure: 65 psig (549 kPa abs) max.

Temperature: 32 to 122 °F (0 to 50 °C)

⚠ WARNING

Physical access

Unauthorized personnel may potentially cause significant damage to and/or misconfiguration of end users' equipment. This could be intentional or unintentional and needs to be protected against.

Physical security is an important part of any security program and fundamental to protecting your system. Restrict physical access by unauthorized personnel to protect end users' assets. This is true for all systems used within the facility.

Contents

First steps.....	3
Install.....	5
Wire.....	7
Calibrate.....	12
Maintenance.....	14
Accessories.....	16

1 First steps

1.1 Unpack and inspect

Procedure

1. Inspect the shipping container. If it is damaged, contact the shipper immediately for instructions.
2. If there is no apparent damage, unpack the container. Be sure all items shown on the packing list are present. If items are missing, notify Emerson immediately.

1.2 Product description

Figure 1-1: Rosemount 499ACL-03 Sensor Parts

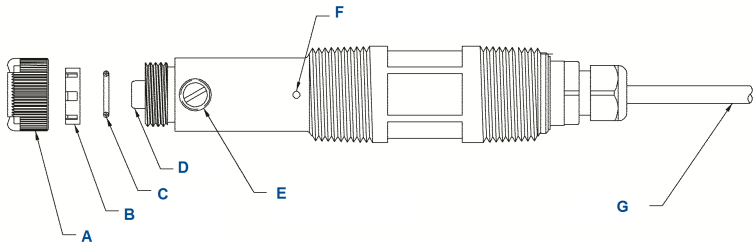

- A. Membrane retainer
- B. Membrane assembly
- C. O-ring
- D. Cathode
- E. Electrolyte fill plug (wrap with pipe tape)
- F. Pressure equalizing port
- G. Sensor cable (integral cable shown)

1.3 Specifications

Table 1-1: Sensor Specifications

Physical characteristics	Specifications
Pressure	Sensor must drain to open atmosphere. No back pressure.
Temperature (operating)	32 to 122 °F (0 to 50 °C)
Process connection	1-in. male national pipe thread (MNPT)
Wetted parts	Noryl®, Viton®, silicone, wood, and Zitex® (PTFE)

Table 1-1: Sensor Specifications (continued)

Physical characteristics	Specifications
Cathode	Gold mesh
Linearity	2% (typical)

Table 1-2: Other Specifications

Type	PN	Wetted materials	Process connection	Maximum temperature	Maximum pressure
Low flow cell with bubble sweeping nozzle ⁽¹⁾	24091-01	Polycarbonate/ polyester, 316 stainless steel, and silicone	Compression fitting for ¼-in. O.D. tubing	158 °F (70 °C)	90 psig (722 kPa abs)

- (1) Flow cell must drain to open atmosphere. Do not install the sensor in a pressurized line. Temperature and pressure specifications for the low flow cell exceed the temperature and pressure specifications for the sensor.

2 Install

Install sensor in the low flow cell (PN 24091-01) only. Keep the flow as constant as possible between 1 and 4 gph (3.8 to 15 L/hr). The flow cell must drain to open atmosphere.

Figure 2-1: Sensor Orientation

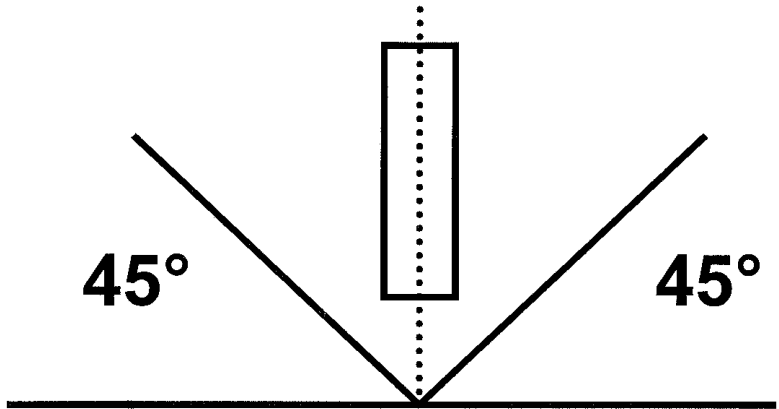

Install sensor within 45 degrees of vertical.

Figure 2-2: Low Flow Cell (PN 24091-00)

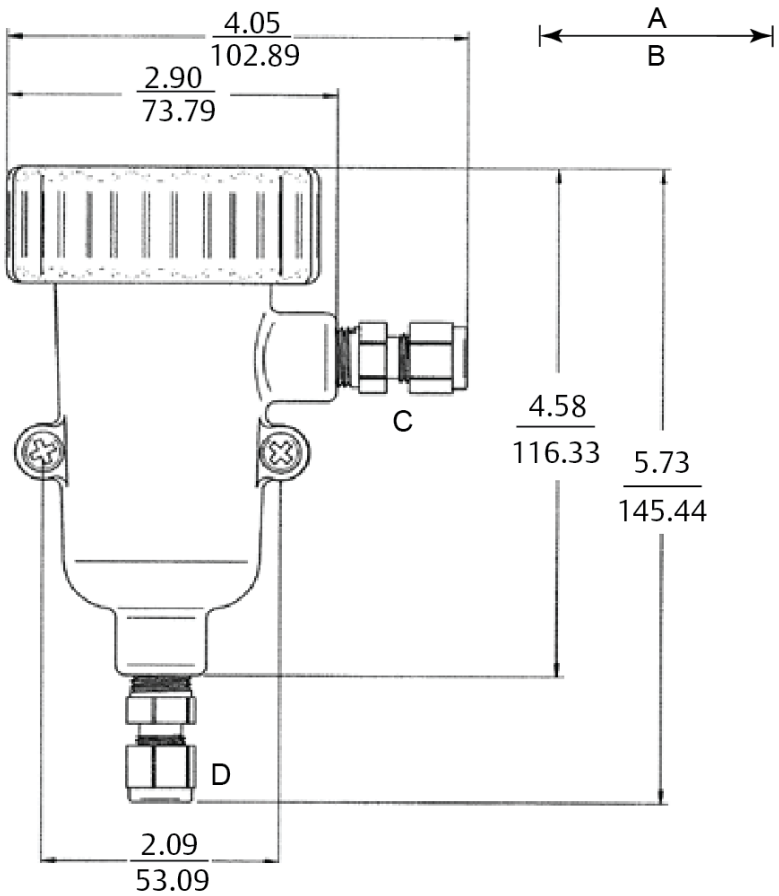

- A. Inches
- B. Millimeters
- C. Outlet
- D. Inlet

3 Wire

NOTICE

For additional wiring information on this product, including sensor combinations not shown here, please refer to the [Liquid Transmitter Wiring Diagrams](#).

Figure 3-1: Rosemount 499ACL-03 Sensor Wiring to Rosemount 1056 and 56 Transmitters

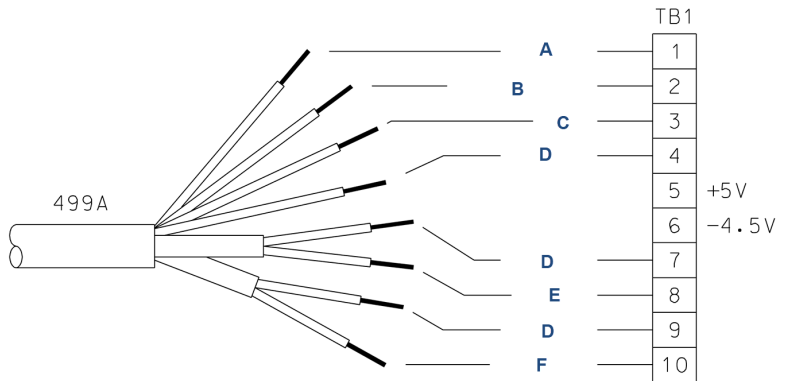

Table 3-1: Rosemount 499ACL-03 Sensor Wiring to Rosemount 1056 and 56 Transmitters

Terminal number	Letter	Wire color	Description
1	A	White	Resistance temperature device (RTD) return
2	B	White/red	RTD sense
3	C	Red	RTD in
4	D	Clear	RTD shield
5	N/A	N/A	+5 V out
6	N/A	N/A	-4.5 V out
7	D	Clear	Anode shield
8	E	Gray	Anode
9	D	Clear	Cathode shield

Table 3-1: Rosemount 499ACL-03 Sensor Wiring to Rosemount 1056 and 56 Transmitters (continued)

Terminal number	Letter	Wire color	Description
10	F	Orange	Cathode

Figure 3-2: Rosemount 499ACL-03 Sensor Wiring to Rosemount 5081 Transmitter

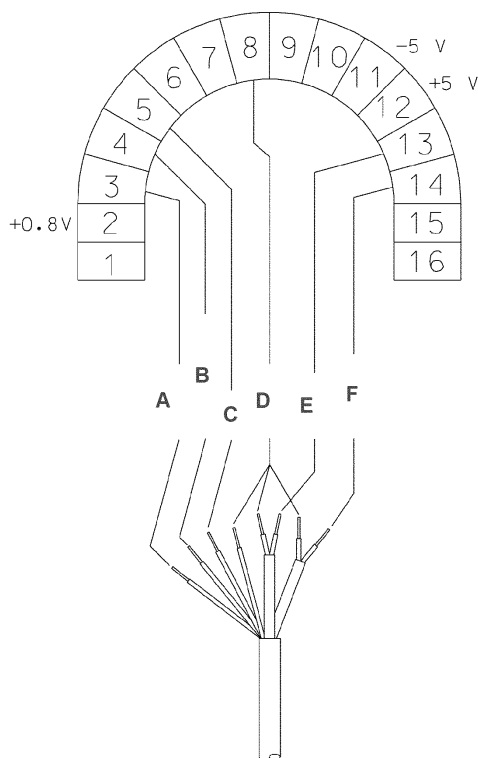

Table 3-2: Rosemount 499ACL-03 Sensor Wiring to Rosemount 5081 Transmitter

Terminal number	Letter	Wire color	Description
1	N/A	N/A	N/A
2	N/A	N/A	+0.8 V
3	A	White	RTD return

Table 3-2: Rosemount 499ACL-03 Sensor Wiring to Rosemount 5081 Transmitter (continued)

Terminal number	Letter	Wire color	Description
4	B	White/red	RTD sense
5	C	Red	RTD in
6	N/A	N/A	Reference guard
7	N/A	N/A	Reference in
8	D	Clear	Solution ground
9	N/A	N/A	pH guard
10	N/A	N/A	pH in
11	N/A	N/A	-5 V
12	N/A	N/A	+5 V
13	E	Gray	Anode
14	F	Orange	Cathode
15	N/A	N/A	HART®/FOUNDATION™ Fieldbus (-)
16	N/A	N/A	HART/FOUNDATION Fieldbus (+)

Figure 3-3: Rosemount 499ACL-03 Sensor Wiring to Rosemount 1066 Transmitter

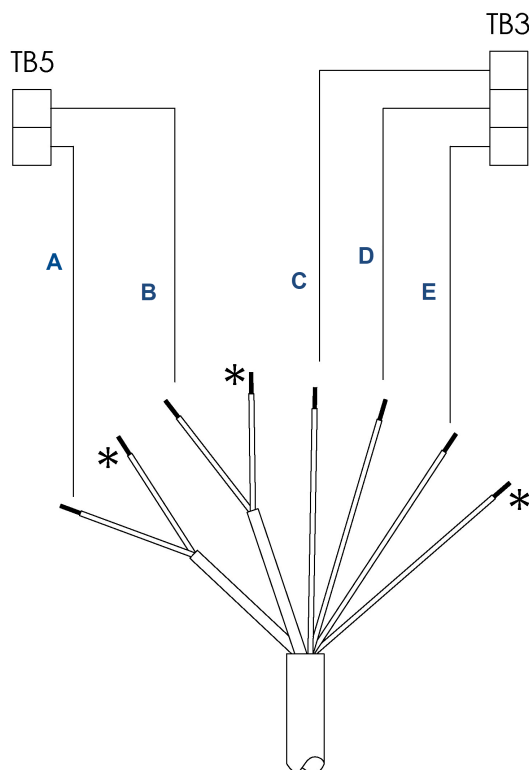

Note

Connect clear shield wires to solution ground terminal on TB 2. Use wire nut and pigtail if necessary.

Table 3-3: Rosemount 499ACL-03 Wiring to Rosemount 1066 Transmitter

Letter	Color	Terminal description
A	Orange	Cathode
B	Gray	Anode
C	White	Return
D	White/red	Sense
E	Red	RTD in

Figure 3-4: Rosemount 499ACL-03-01-54-VP Sensor Pin-out Diagram (Top View of Connector End of Sensor)

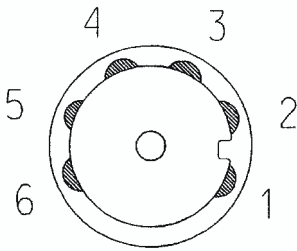

Table 3-4: Pin-out Diagram

Terminal number	Description
1	Cathode
2	N/A
3	RTD sense
4	Anode
5	RTD return
6	RTD in

When making a connection through a junction box (PN 23550-00), wire point-to-point.

NOTICE

Use a wire nut and pigtail (included) when connecting several wires to the same terminal.

4 Calibrate

4.1 Zero point calibration

Even in the absence of monochloramine, the sensor generates a small signal called the zero current. Failing to correct for the zero current can introduce a bias, particularly if the monochloramine concentration is small (<0.4 ppm). Zero the sensor when it is first placed in service and every time the fill solution is changed.

To zero the sensor:

Procedure

1. Pour a cup of deionized or bottled water.
2. Place the sensor in the water.
3. Wait until the sensor current has reached a stable low value (at least two hours).
4. Follow the transmitter prompts for zeroing the sensor.

Note

Refer to the manual for the transmitter you are using (Rosemount 56, 1056, or 1066).

The zero current should be between -10 and +15 nA. For more information, refer to the transmitter manual.

4.2 Full scale calibration

Because stable dilute monochloramine standards are not available, the sensor must be calibrated against the results of a laboratory test run on a grab sample of the process liquid.

Procedure

1. Place the sensor in the flow cell.
2. Start the sample and reagent flow.
3. Adjust the sample flow to between 1 and 4 gph.
4. Adjust the concentration so that it is near the upper end of the operating range.
5. Wait for the readings to stabilize.
6. Follow the transmitter prompts to complete the calibration.

Note

Refer to the manual for the transmitter you are using (Rosemount 56, 1056, or 1066).

Be sure taking the sample does not alter flow to the sensor.

7. After calibration, go to the **Diagnostics** menu and check the sensitivity.

The sensitivity should be between 250 and 450 nA/ppm. For more information, refer to the transmitter manual.

5 Maintenance

⚠ WARNING

Pressurized spray injury

Before removing the sensor, be absolutely certain that the process pressure is reduced to 0 psig and the process temperature is lowered to a safe level!

5.1 Cleaning the membrane

Keep the membrane clean and free from dirt and algae. Periodically inspect the membrane. If it appears fouled, clean the membrane with water sprayed from a wash bottle.

⚠ CAUTION

EQUIPMENT DAMAGE

Do not wipe the membrane with a tissue. Do not touch the membrane. Doing so may damage the cathode, making the sensor unusable.

5.2 Replacing the electrolyte solution and membrane

⚠ WARNING

Corrosive substance

Fill solution is corrosive.

Avoid contact with skin and eyes.

Consult Material Safety Data Sheet (MSDS) for safety information.

Procedure

1. Unscrew the membrane retainer.
2. Remove the membrane assembly and O-ring.
See [Figure 1-1](#).
3. Hold the sensor over a container with the cathode pointing down.
4. Remove the fill plug.
5. Allow the electrolyte solution to drain out.
6. Remove the old pipe tape from the plug.
7. Wrap the plug with one or two turns of pipe tape..
8. Prepare a new membrane.

- a) Hold the membrane assembly with the cup formed by the membrane and membrane holder pointing up.
 - b) Fill the cup with electrolyte solution.
9. Hold the sensor at about a 45 degree angle with the cathode end pointing up.
 10. Add electrolyte solution through the fill hole until the liquid overflows.
 11. Tap the sensor near the threads to release trapped air bubbles.
 12. Add more electrolyte solution if necessary.
 13. Place the fill plug in the electrolyte port and begin screwing it in.
 14. After several threads have engaged, rotate the sensor so that the cathode is pointing up and continue tightening the fill plug.
Do not overtighten.
 15. Place a new O-ring in the groove around the cathode post.
 16. Cover the cathode with electrolyte solution; then place the membrane assembly over the cathode.
 17. Screw the membrane retainer in place.
 18. Hold the sensor with the cathode end pointing down.
 19. Give the sensor several sharp shakes to dislodge air bubbles trapped behind the cathode.
The sensor may require several hours operating at the polarizing voltage to equilibrate after the electrolyte solution has been replaced.

6 Accessories

Part #	Description
23750-00	Electrolyte fill plug with wooden osmotic pressure relief port
9550094	O-ring, Viton 2-014
33521-00	Membrane retainer
23501-09	Monochloramine membrane assembly: includes one membrane assembly and one O-ring
23502-09	Monochloramine membrane kit: includes three membrane assemblies and three O-rings
9210372	Monochloramine sensor fill solution, 4 oz (120 mL)



GLOBAL HEADQUARTERS

6021 Innovation Blvd.
Shakopee, MN 55379

- +1 866 347 3427
- +1 952 949 7001
- liquid.csc@emerson.com

NORTH AMERICA

Emerson Automation Solutions
8200 Market Blvd
Chanhassen, MN 55317

- Toll Free +1 800 999 9307
- F +1 952 949 7001
- liquid.csc@emerson.com

MIDDLE EAST AND AFRICA

Emerson Automation Solutions
Emerson FZE
Jebel Ali Free Zone
Dubai, United Arab Emirates, P.O. Box
17033

- +971 4 811 8100
- +971 4 886 5465
- liquid.csc@emerson.com

 [Linkedin.com/company/Emerson-Automation-Solutions](https://www.linkedin.com/company/Emerson-Automation-Solutions)

 twitter.com/rosemount_news

 [Facebook.com/Rosemount](https://www.facebook.com/Rosemount)

 [youtube.com/RosemountMeasurement](https://www.youtube.com/RosemountMeasurement)

EUROPE

Emerson Automation Solutions
Neuhofstrasse 19a PO Box 1046
CH-6340 Baar
Switzerland

- +41 (0) 41 768 6111
- +41 (0) 41 768 6300
- liquid.csc@emerson.com

ASIA-PACIFIC

Emerson Automation Solutions
1 Pandan Crescent
Singapore 128461
Republic of Singapore

- +65 6 777 8211
- +65 6 777 0947
- liquid.csc@emerson.com

©2019 Emerson. All rights reserved.

The Emerson logo is a trademark and service mark of Emerson Electric Co. Rosemount is a mark of one of the Emerson family of companies. All other marks are the property of their respective owners.