

E40260

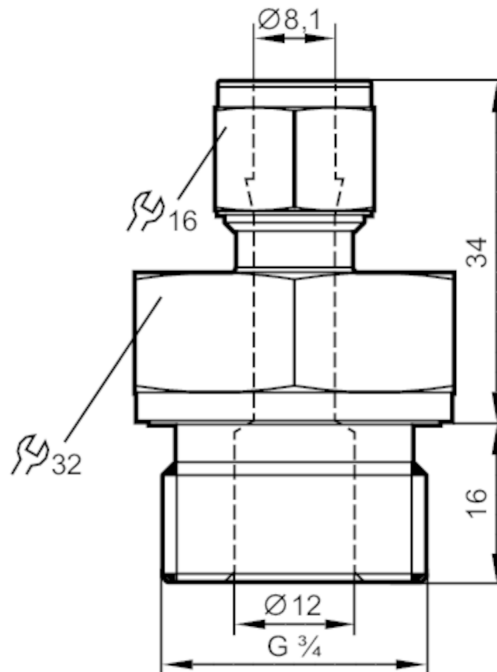

Progressive ring fitting

COMPRESSION FITTING G3/4



Application	
Installation	Progressive ring fitting
Pressure rating [bar]	50
Mechanical data	
Weight [g]	159.3
Materials	stainless steel (1.4404 / 316L); Gasket: FKM
Sensor connection	Ø 8 mm
Process connection	threaded connection G 3/4
Accessories	
Items supplied	Gasket
Remarks	
Pack quantity	1 pcs.