

**YTA610 and YTA710
Temperature Transmitters
(HART Protocol)**

IM 01C50T01-02EN

vigilantplant.[®]

YTA610 and YTA710

Temperature Transmitters

(HART Protocol)

IM 01C50T01-02EN 3rd Edition

CONTENTS

1.	Introduction	1-1
	■ Regarding This Manual	1-1
	■ For Safe Use of Product	1-2
	■ Warranty	1-2
	■ ATEX Documentation	1-3
1.1	Matching of DD and Instruments	1-4
2.	Connection.....	2-1
2.1	Integral Indicator Display When Powering On	2-1
2.2	Interconnection between YTA and HART Configuration Tool	2-1
2.3	Power Supply Voltage and Load Resistance	2-1
3.	Parameter Setting.....	3-1
3.1	Menu Tree	3-1
3.2	Parameter Description	3-10
3.3	Review	3-11
3.4	Basic Setup.....	3-12
3.4.1	Sensor Configuration	3-12
3.4.2	Process Variable Mapping	3-12
3.4.3	Unit.....	3-13
3.4.4	PV Range.....	3-13
3.4.5	Damping Time Constant	3-13
3.5	Detailed Setup	3-14
3.5.1	Device Information	3-14
3.5.2	Test Output.....	3-14
3.5.3	Burnout Function.....	3-15
3.5.4	Integral Indicator Display Mode	3-15
3.5.5	Write Protect	3-16
3.5.6	Sensor Trim.....	3-16
3.5.7	Analog Output Trim	3-17
3.5.8	Sensor Backup (For dual input type only).....	3-17
3.5.9	Burst Mode.....	3-18
3.5.10	Multidrop Mode	3-20

3.5.11	Sensor Matching Function	3-21
3.5.12	CJC Selection	3-22
3.5.13	TC User Table	3-22
3.5.14	Simulation	3-23
3.5.15	Squawk	3-23
4.	Diagnostics	4-1
4.1	Self-Diagnostics	4-1
4.1.1	Checking for Problems	4-1
4.1.2	Status Information	4-1
4.2	Logging Functions.....	4-4
4.3	Diagnostics Function	4-4
5.	Parameters Lists	5-1
Appendix A.	Safety Instrumented Systems Installation	A-1
A.1	Scope and Purpose	A-1
A.2	Using the YTA for an SIS Application	A-1
A.2.1	Safety Accuracy	A-1
A.2.2	Diagnostic Response Time	A-1
A.2.3	Setup	A-1
A.2.4	Required Parameter Settings	A-1
A.2.5	Proof Testing	A-2
A.2.6	Repair and Replacement	A-3
A.2.7	Startup Time	A-3
A.2.8	Firmware Update	A-3
A.2.9	Reliability Data	A-3
A.2.10	Lifetime Limits	A-3
A.2.11	Environmental Limits	A-3
A.2.12	Application Limits	A-3
A.3	Terms and Definitions	A-3
Revision Information		

1. Introduction

Thank you for purchasing the YTA series Temperature Transmitter.

The YTA series Temperature Transmitters are correctly calibrated at the factory before shipment. To ensure correct and efficient use of the instrument, please read this manual thoroughly and fully understand how to operate the instrument before operating it.

This manual describes that communication function of YTA series conforms to HART protocol and offers instruction for setting parameters for YTA Temperature Transmitters. In regards to the installation, wiring and maintenance of the YTA series Temperature Transmitter, please refer to the Instruction Manual “YTA610 and YTA710 Temperature Transmitters Hardware Manual IM 01C50G01-01EN.”

■ Regarding This Manual

- This manual should be passed on to the end user.
- The contents of this manual are subject to change without prior notice.
- All rights reserved. No part of this manual may be reproduced in any form without Yokogawa’s written permission.
- Yokogawa makes no warranty of any kind with regard to this manual, including, but not limited to, implied warranty of merchantability and fitness for a particular purpose.
- If any question arises or errors are found, or if any information is missing from this manual, please inform the nearest Yokogawa sales office.
- The specifications covered by this manual are limited to those for the standard type under the specified model number break-down and do not cover custom-made instrument.
- Please note that changes in the specifications, construction, or component parts of the instrument may not immediately be reflected in this manual at the time of change, provided that postponement of revisions will not cause difficulty to the user from a functional or performance standpoint.

- The following safety symbol marks are used in this Manual:



WARNING

Indicates a potentially hazardous situation which, if not avoided, could result in death or serious injury.



CAUTION

Indicates a potentially hazardous situation which, if not avoided, may result in minor or moderate injury. It may also be used to alert against unsafe practices.



IMPORTANT

Indicates that operating the hardware or software in this manner may damage it or lead to system failure.



NOTE

Draws attention to information essential for understanding the operation and features.

■ For Safe Use of Product

For the protection and safety of the operator and the instrument or the system including the instrument, please be sure to follow the instructions on safety described in this manual when handling this instrument. In case the instrument is handled in contradiction to these instructions, Yokogawa does not guarantee safety. Please give your attention to the followings.

(a) Installation

- The instrument must be installed by an expert engineer or a skilled personnel. The procedures described about INSTALLATION are not permitted for operators.
- In case of high process temperature, care should be taken not to burn yourself because the surface of the case reaches a high temperature.
- All installation shall comply with local installation requirement and local electrical code.

(b) Wiring

- The instrument must be installed by an expert engineer or a skilled personnel. The procedures described about WIRING are not permitted for operators.
- Please confirm that voltages between the power supply and the instrument before connecting the power cables and that the cables are not powered before connecting.

(c) Maintenance

- Please do not carry out except being written to a maintenance descriptions. When these procedures are needed, please contact nearest YOKOGAWA office.
- Care should be taken to prevent the build up of drift, dust or other material on the display glass and name plate. In case of its maintenance, soft and dry cloth is used.

(d) Modification

- Yokogawa will not be liable for malfunctions or damage resulting from any modification made to this instrument by the customer.

(e) Product Disposal

The instrument should be disposed of in accordance with local and national legislation/regulations.

(f) Authorized Representative in EEA

In relation to the CE Marking, The authorized representative for this product in the EEA (European Economic Area) is:
Yokogawa Europe B.V.
Euroweg 2, 3825 HD Amersfoort, The Netherlands

■ Warranty

- The warranty shall cover the period noted on the quotation presented to the purchaser at the time of purchase. Problems occurred during the warranty period shall basically be repaired free of charge.
- In case of problems, the customer should contact the Yokogawa representative from which the instrument was purchased, or the nearest Yokogawa office.
- If a problem arises with this instrument, please inform us of the nature of the problem and the circumstances under which it developed, including the model specification and serial number. Any diagrams, data and other information you can include in your communication will also be helpful.
- Responsible party for repair cost for the problems shall be determined by Yokogawa based on our investigation.
- The Purchaser shall bear the responsibility for repair costs, even during the warranty period, if the malfunction is due to:
 - Improper and/or inadequate maintenance by the purchaser.
 - Failure or damage due to improper handling, use or storage which is out of design conditions.
 - Use of the product in question in a location not conforming to the standards specified by Yokogawa, or due to improper maintenance of the installation location.
 - Failure or damage due to modification or repair by any party except Yokogawa or an approved representative of Yokogawa.
 - Malfunction or damage from improper relocation of the product in question after delivery.
 - Reason of force majeure such as fires, earthquakes, storms/floods, thunder/lightening, or other natural disasters, or disturbances, riots, warfare, or radioactive contamination.

■ ATEX Documentation

This procedure is only applicable to the countries in European Union.

<p>GB All instruction manuals for ATEX Ex related products are available in English, German and French. Should you require Ex related instructions in your local language, you are to contact your nearest Yokogawa office or representative.</p>	<p>SK Všetky návody na obsluhu pre prístroje s ATEX Ex sú k dispozícii v jazyku anglickom, nemeckom a francúzskom. V prípade potreby návodu pre Ex-prístroje vo Vašom národnom jazyku, skontaktujte prosím miestnu kanceláriu firmy Yokogawa.</p>
<p>DK Alle brugervejledninger for produkter relateret til ATEX Ex er tilgængelige på engelsk, tysk og fransk. Skulle De ønske yderligere oplysninger om håndtering af Ex produkter på eget sprog, kan De rette henvendelse herom til den nærmeste Yokogawa afdeling eller forhandler.</p>	<p>CZ Všechny uživatelské příručky pro výrobky, na něž se vztahuje nevybušné schválení ATEX Ex, jsou dostupné v angličtině, němčině a francouzštině. Požadujete-li pokyny týkající se výrobků s nevybušným schválením ve vašem lokálním jazyku, kontaktujte prosím vaši nejbližší reprezentační kancelář Yokogawa.</p>
<p>I Tutti i manuali operativi di prodotti ATEX contrassegnati con Ex sono disponibili in inglese, tedesco e francese. Se si desidera ricevere i manuali operativi di prodotti Ex in lingua locale, mettersi in contatto con l'ufficio Yokogawa più vicino o con un rappresentante.</p>	<p>LT Visos gaminio ATEX Ex kategorijos Eksploatavimo instrukcijos teikiama anglų, vokiečių ir prancūzų kalbomis. Norėdami gauti prietaisų Ex dokumentaciją kitomis kalbomis susisieki su artimiausiu bendrovės "Yokogawa" biuru arba atstovu.</p>
<p>E Todos los manuales de instrucciones para los productos antiexplosivos de ATEX están disponibles en inglés, alemán y francés. Si desea solicitar las instrucciones de estos artículos antiexplosivos en su idioma local, deberá ponerse en contacto con la oficina o el representante de Yokogawa más cercano.</p>	<p>LV Visas ATEX Ex kategorijas izstrādājumu Lietošanas instrukcijas tiek piegādātas angļu, vācu un franču valodās. Ja vēlaties saņemt Ex ierīšu dokumentāciju citā valodā, Jums ir jāsazinās ar firmas Jokogava (Yokogawa) tuvāko ofisu vai pārstāvi.</p>
<p>NL Alle handleidingen voor producten die te maken hebben met ATEX explosiebeveiliging (Ex) zijn verkrijgbaar in het Engels, Duits en Frans. Neem, indien u aanwijzingen op het gebied van explosiebeveiliging nodig hebt in uw eigen taal, contact op met de dichtstbijzijnde vestiging van Yokogawa of met een vertegenwoordiger.</p>	<p>EST Kõik ATEX Ex toodete kasutamjuhendid on esitatud inglise, saksa ja prantsuse keeles. Ex seadmete muukeelse dokumentatsiooni saamiseks pöörduge lähima lokagava (Yokogawa) kontori või esindaja poole.</p>
<p>SF Kaikkien ATEX Ex -tyyppisten tuotteiden käyttöohjeet ovat saatavilla englannin-, saksan- ja ranskan kielisinä. Mikäli tarvitsette Ex -tyyppisten tuotteiden ohjeita omalla paikallisella kielellänne, ottakaa yhteyttä lähimpään Yokogawa-toimistoon tai -edustajaan.</p>	<p>PL Wszystkie instrukcje obsługi dla urządzeń w wykonaniu przeciwwybuchowym Ex, zgodnych z wymaganiami ATEX, dostępne są w języku angielskim, niemieckim i francuskim. Jeżeli wymagana jest instrukcja obsługi w Państwa lokalnym języku, prosimy o kontakt z najbliższym biurem Yokogawy.</p>
<p>P Todos os manuais de instruções referentes aos produtos Ex da ATEX estão disponíveis em Inglês, Alemão e Francês. Se necessitar de instruções na sua língua relacionadas com produtos Ex, deverá entrar em contacto com a delegação mais próxima ou com um representante da Yokogawa.</p>	<p>SLO Vsi predpisi in navodila za ATEX Ex sorodni pridelki so pri roki v angleščini, nemščini ter francoščini. Če so Ex sorodna navodila potrebna v vašem tujejnem jeziku, kontaktirajte vaš najbliži Yokogawa office ili predstavnika.</p>
<p>F Tous les manuels d'instruction des produits ATEX Ex sont disponibles en langue anglaise, allemande et française. Si vous nécessitez des instructions relatives aux produits Ex dans votre langue, veuillez bien contacter votre représentant Yokogawa le plus proche.</p>	<p>H Az ATEX Ex műszerek gépkönyveit angol, német és francia nyelven adjuk ki. Amennyiben helyi nyelven kéri az Ex eszközök leírásait, kérjük keressék fel a legközelebbi Yokogawa irodát, vagy képviselőt.</p>
<p>D Alle Betriebsanleitungen für ATEX Ex bezogene Produkte stehen in den Sprachen Englisch, Deutsch und Französisch zur Verfügung. Sollten Sie die Betriebsanleitungen für Ex-Produkte in Ihrer Landessprache benötigen, setzen Sie sich bitte mit Ihrem örtlichen Yokogawa-Vertreter in Verbindung.</p>	<p>BG Всички упътвания за продукти от серията ATEX Ex се предлагат на английски, немски и френски език. Ако се нуждаете от упътвания за продукти от серията Ex на родния ви език, се свържете с най-близкия офис или представителство на фирма Yokogawa.</p>
<p>S Alla instruktionsböcker för ATEX Ex (explosionssäkra) produkter är tillgängliga på engelska, tyska och franska. Om Ni behöver instruktioner för dessa explosionssäkra produkter på annat språk, skall Ni kontakta närmaste Yokogawakontor eller representant.</p>	<p>RO Toate manualele de instructiuni pentru produsele ATEX Ex sunt in limba engleza, germana si franceza. In cazul in care doriti instructiunile in limba locala, trebuie sa contactati cel mai apropiat birou sau reprezentant Yokogawa.</p>
<p>GR Όλα τα εγχειρίδια λειτουργίας των προϊόντων με ATEX Ex διατίθενται στα Αγγλικά, Γερμανικά και Γαλλικά. Σε περίπτωση που χρειάζεστε οδηγίες σχετικά με Ex στην τοπική γλώσσα παρακαλούμε επικοινωνήστε με το πλησιέστερο γραφείο της Yokogawa ή αντιπρόσωπο της.</p>	<p>M Il-manwali kollha ta' l-Istruzzjonijiet għal prodotti marbuta ma' ATEX Ex huma disponibbli bi-Ingliż, bi-Germaniż u bi-Franċiż. Jekk tkun teħtieg struzzjonijiet marbuta ma' Ex fil-lingwa lokali tiegħek, għandek tikkuntattja l-ill-eqreb rappreżentant jew ufficcju ta' Yokogawa.</p>

1.1 Matching of DD and Instruments

Before using a HART configuration tool, confirm that the DD for the instrument is installed in the configuration tool.

Device type:

Device Revision:

DD Revision:

The device revision of the transmitter and DD can be confirmed as shown below. If the correct DD is not installed in the configuration tool, download it from the official web site of HART Communication Foundation.

(1) Confirmation of device revision for the transmitter

- Confirmation on integral indicator
(A case of integral indicator code D is specified)
Refer to the section 2.1
- Confirmation by using HART configuration tool
 - a) Connect the configuration tool to the transmitter.
 - b) Confirm numerical number displayed on “Fld dev rev” column.
- Procedure to call up the display
Device Setup → Detailed Setup → Device Information → Revision#’s → Fld dev rev

(2) Confirmation of device revision for the configuration tool

Confirm the device revision from the installed DD file name according to the procedure provided for the configuration tool.

The first two digits indicate the device revision and the next two digits indicate the DD revision.

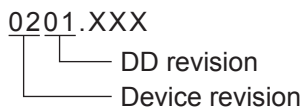

NOTE

Device revision of DD file is given in hexadecimal.

2. Connection

2.1 Integral Indicator Display When Powering On

For models with the integral indicator code “D”, the display shows all segments in the LCD and then changes to the displays shown below sequentially.

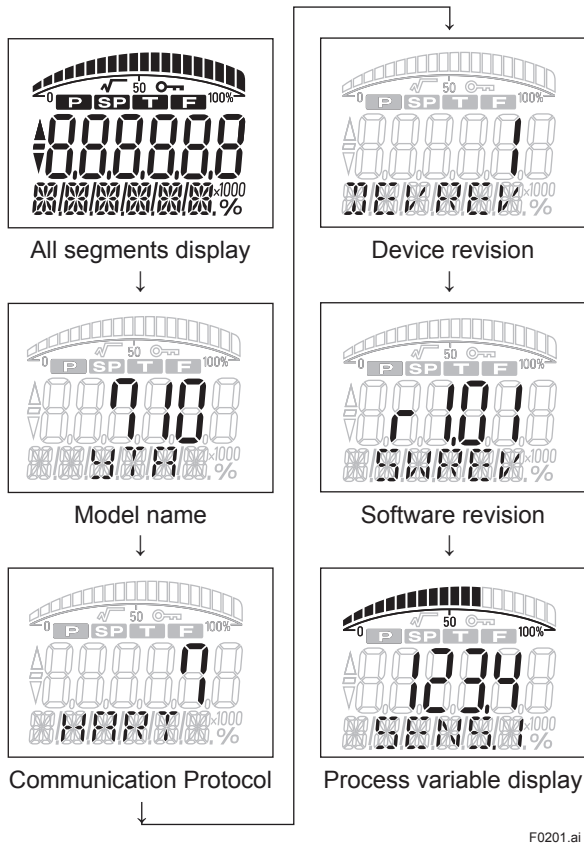

2.2 Interconnection between YTA and HART Configuration Tool

The HART configuration tool can interface with the transmitter from the control room, the transmitter site, or any other wiring termination point in the loop. To communicate, the tool must be connected to the signal line in parallel with the transmitter; the connections are non-polarized. The HART digital signal is superimposed on the analog signal. Figure 2.1 illustrates the wiring connections for direct interface at the transmitter site for the YTA. The HART configuration tool can be used for remote access from any terminal strip as well.

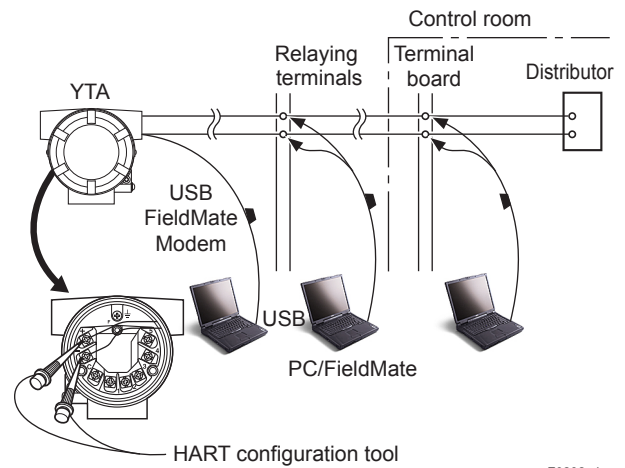

Figure 2.1 Connecting the HART Configuration Tool

2.3 Power Supply Voltage and Load Resistance

When configuring the loop, make sure that the external load resistance is within the range in the figure below.

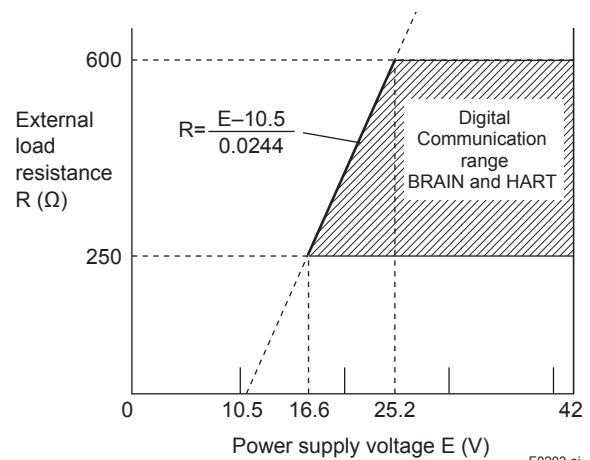

Figure 2.2

3. Parameter Setting



IMPORTANT

Do not turn off the power to the transmitter immediately after transfer of the data from HART Communicator. If the transmitter is turned off in less than 30 seconds after parameters has been set, the setting data will not be stored and the transmitter will return to the previous settings.



NOTE

Parameters and functions in regards to Sensor2 are offered only for double sensor inputs specification.

3.1 Menu Tree

The structure of menu tree varies according to configuration tool based on DD or DTM.

Root Menu

- **Device root menu**
 - Device setup
- **Diagnostics root menu**
 - Diag/Service
- **Process variables root menu**
 - Process variables
- **Maintenance root menu**
 - Device Status
 - Test Device
 - Calibration

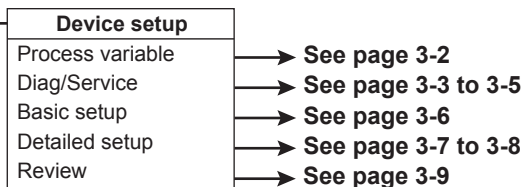

(M): Method
(E): Edit display

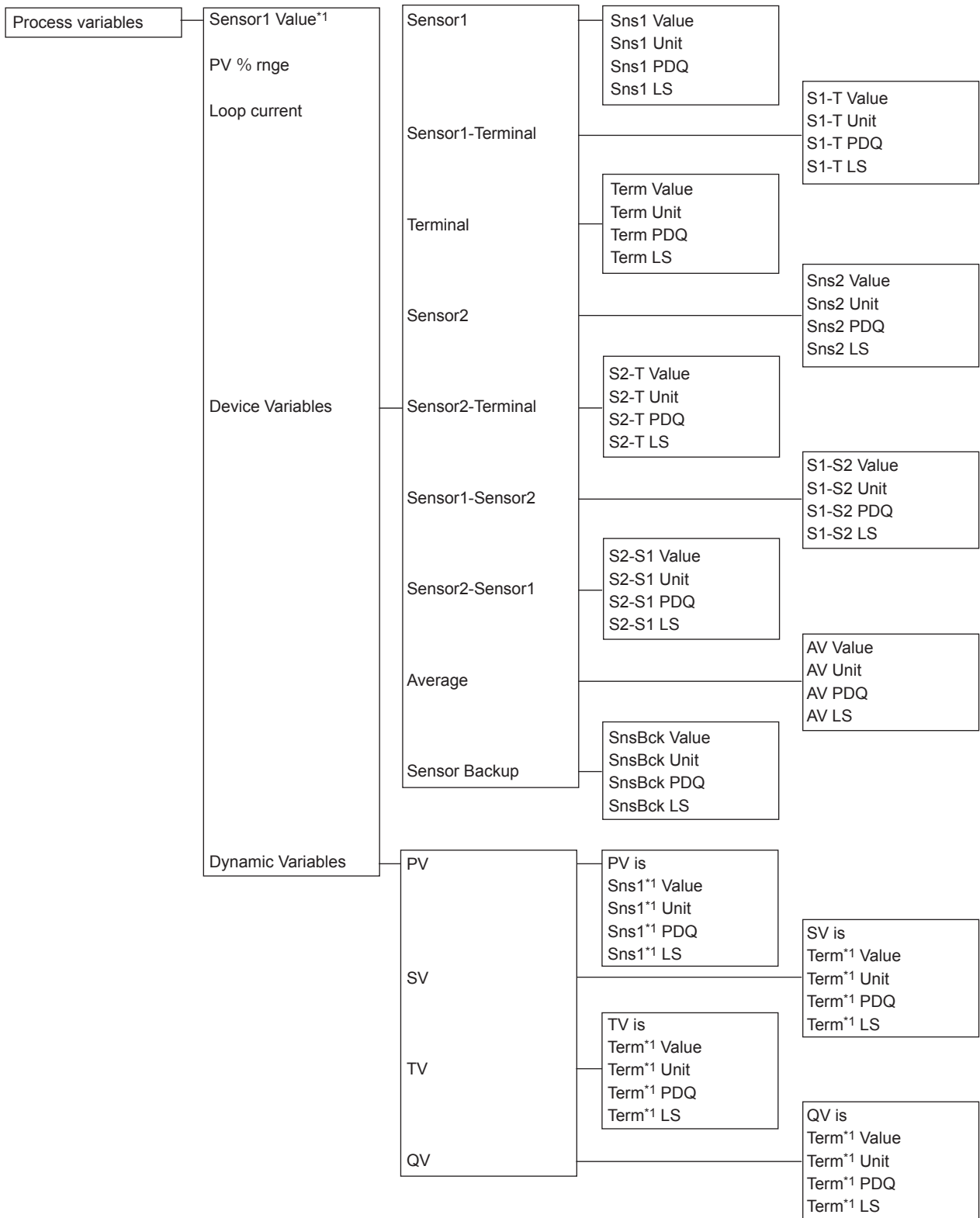

*1: Parameter depends on the process variable mapping.

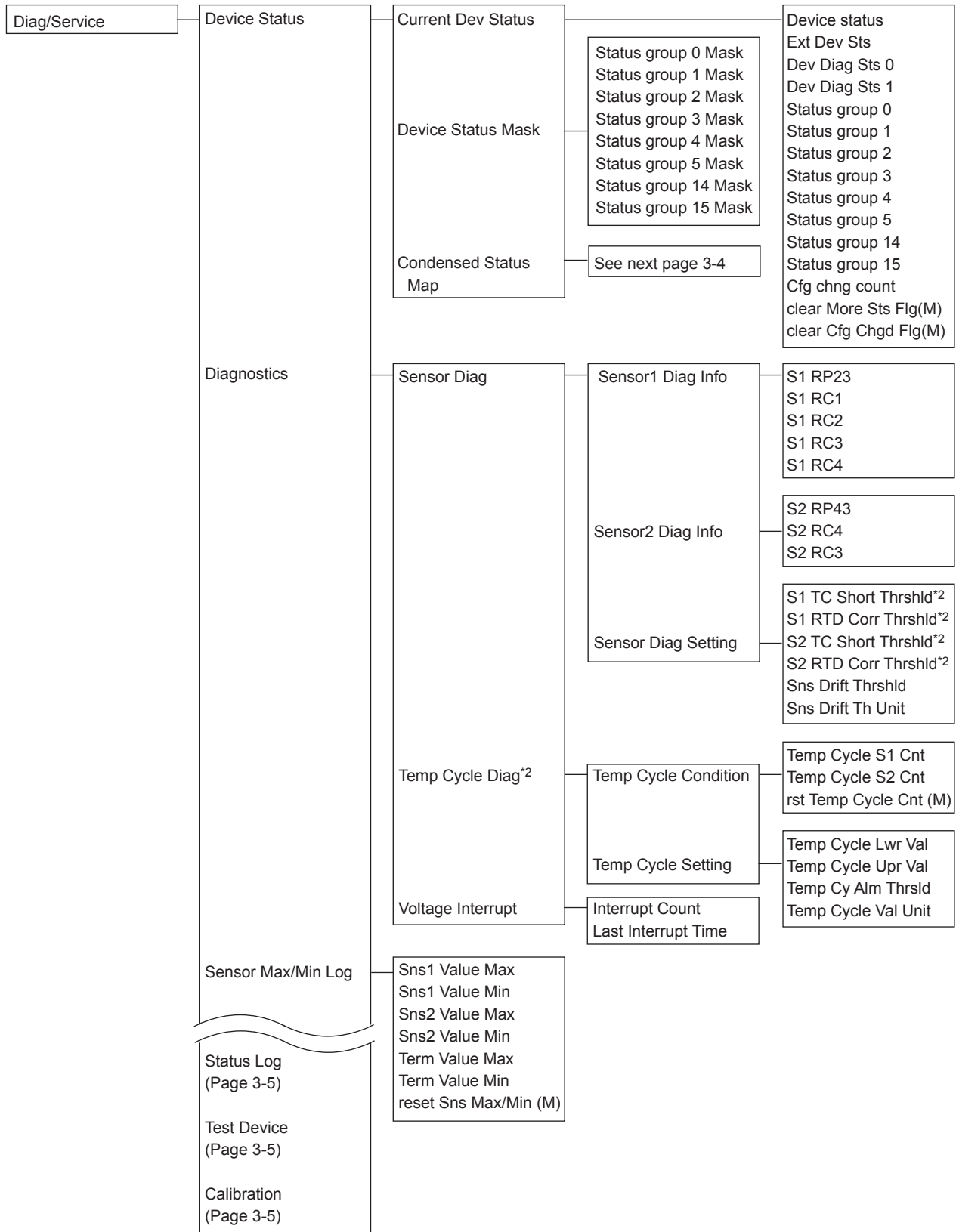

*2: Applicable only for YTA710.

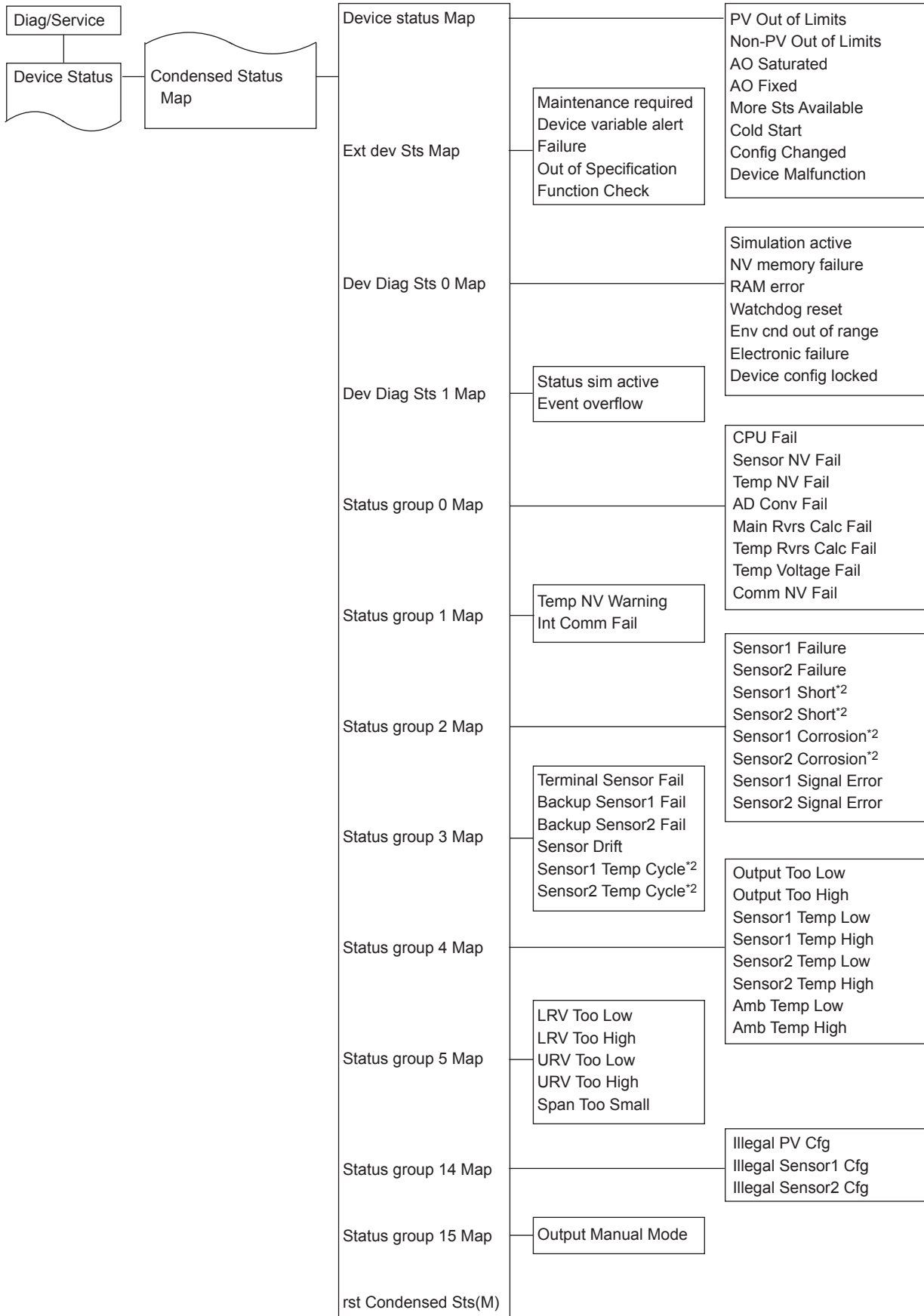

*2: Applicable only for YTA710.

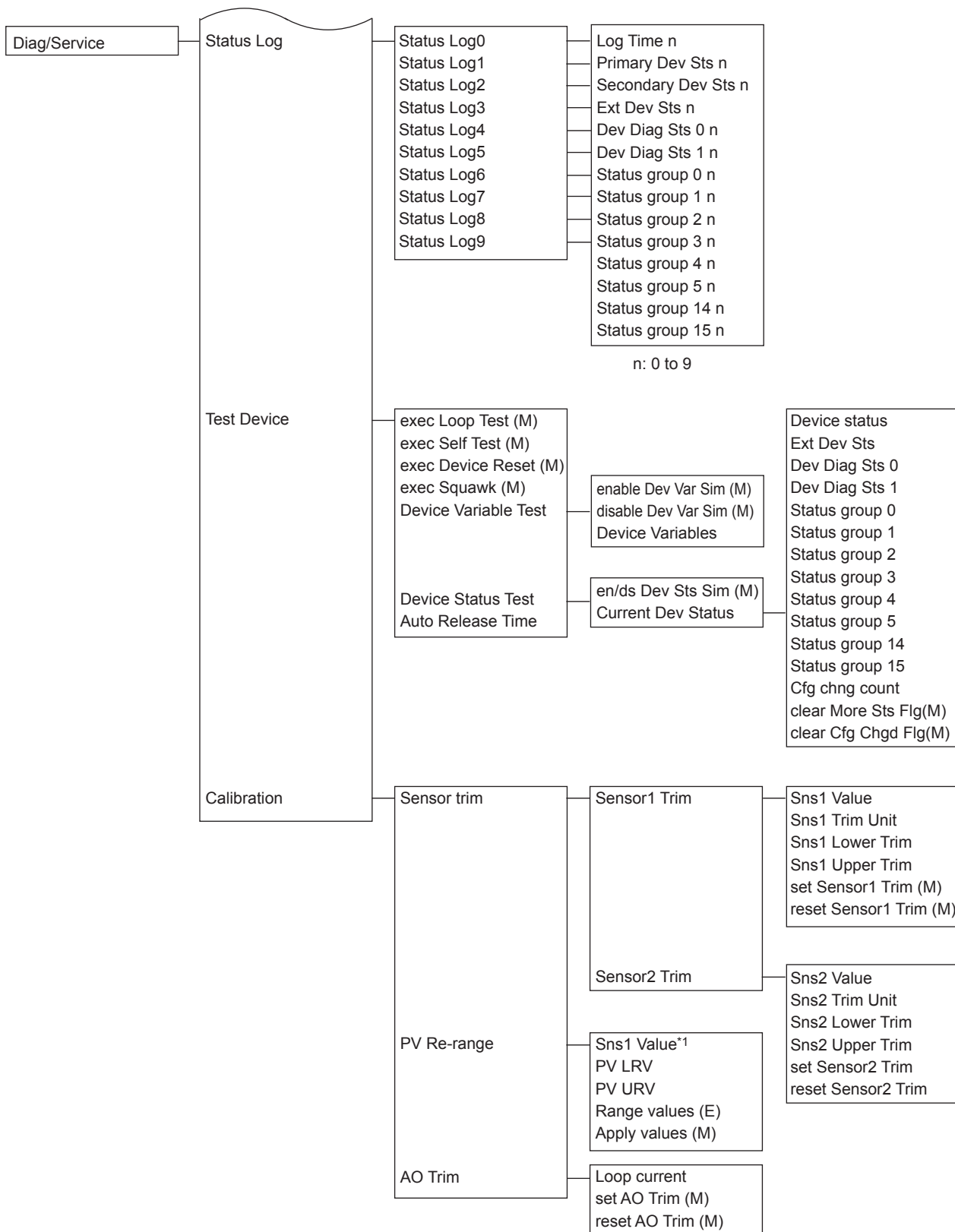

*1: Parameter depends on the process variable mapping.

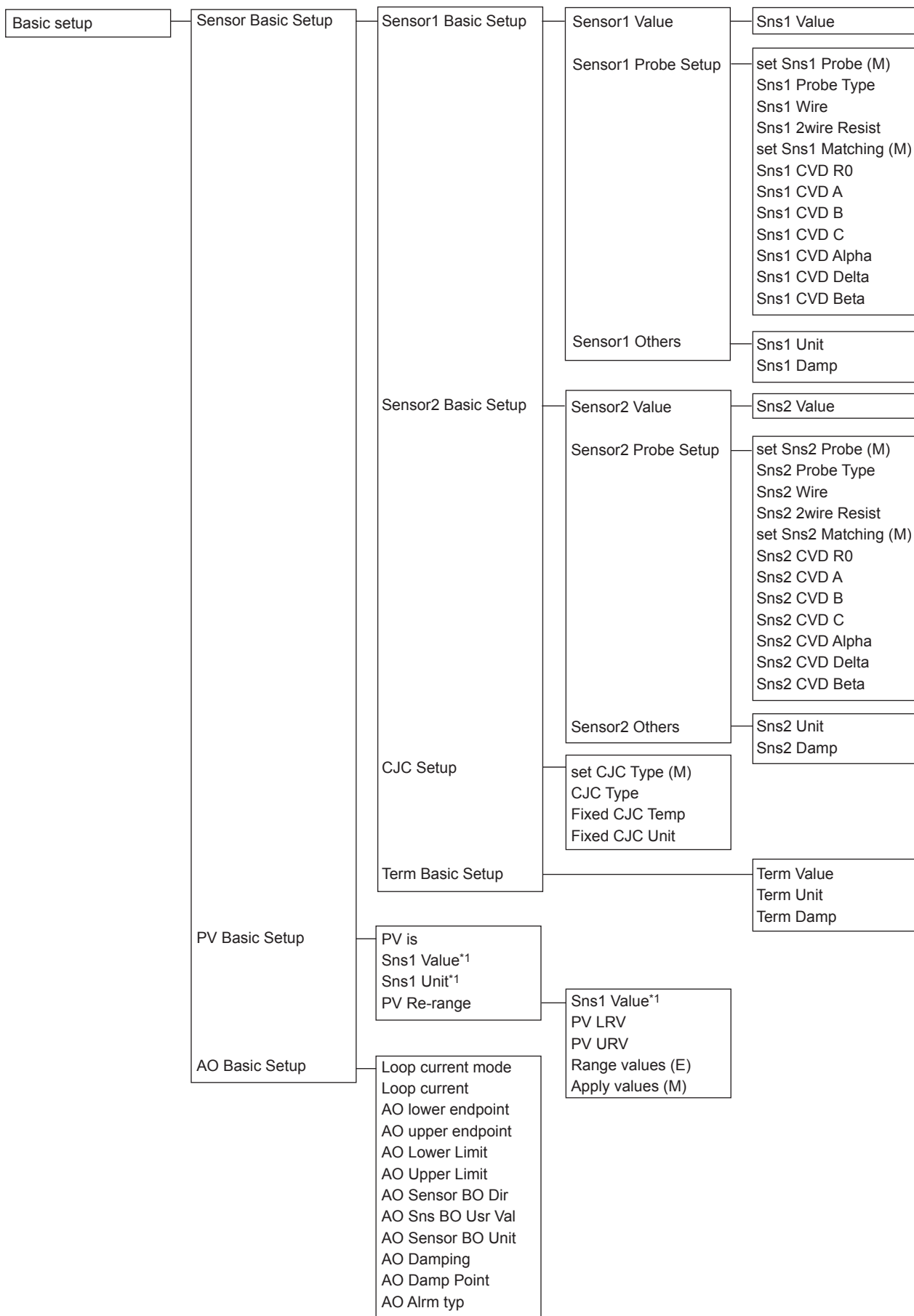

*1: Parameter depends on the process variable mapping.

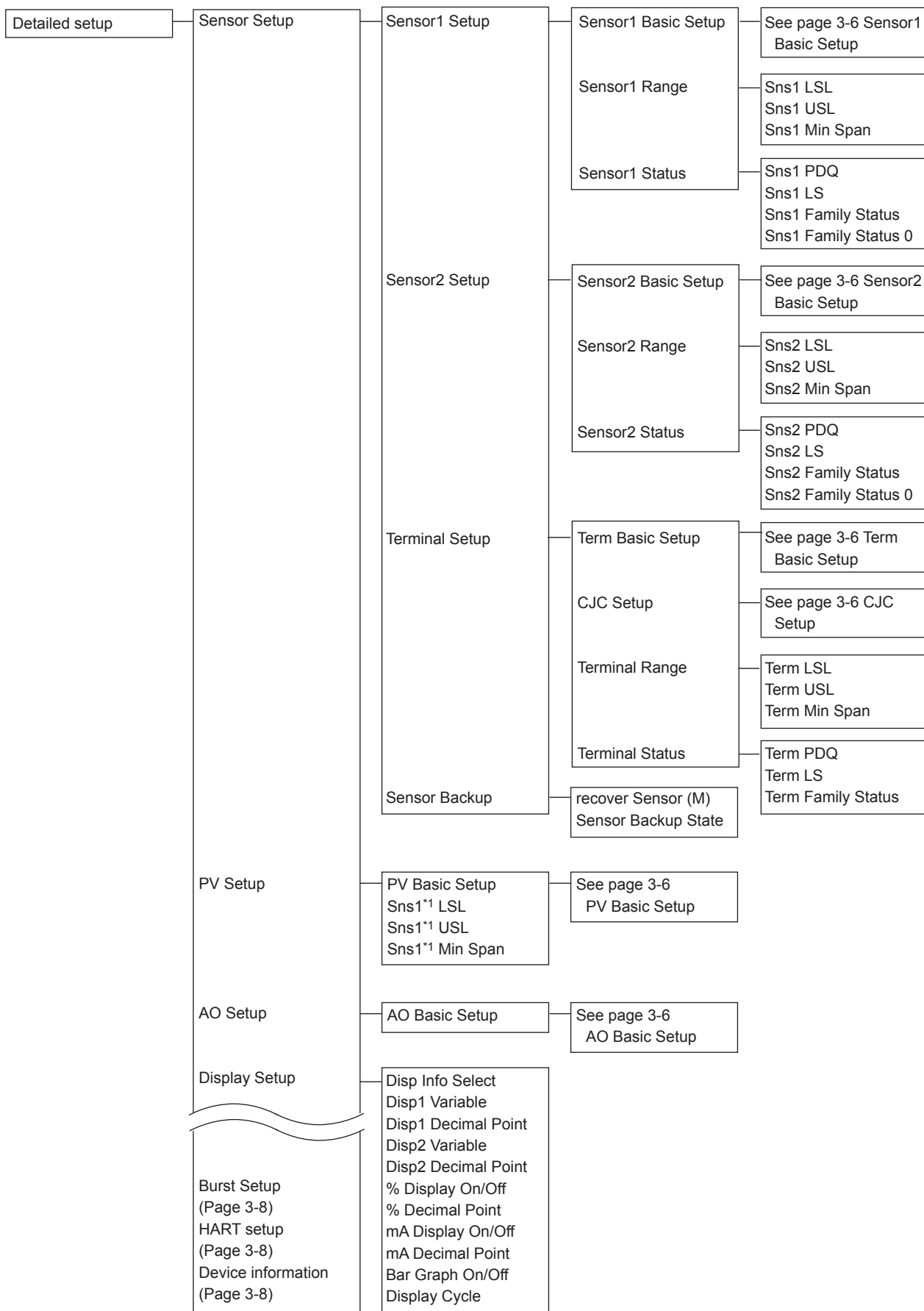

*1: Parameter depends on the process variable mapping.

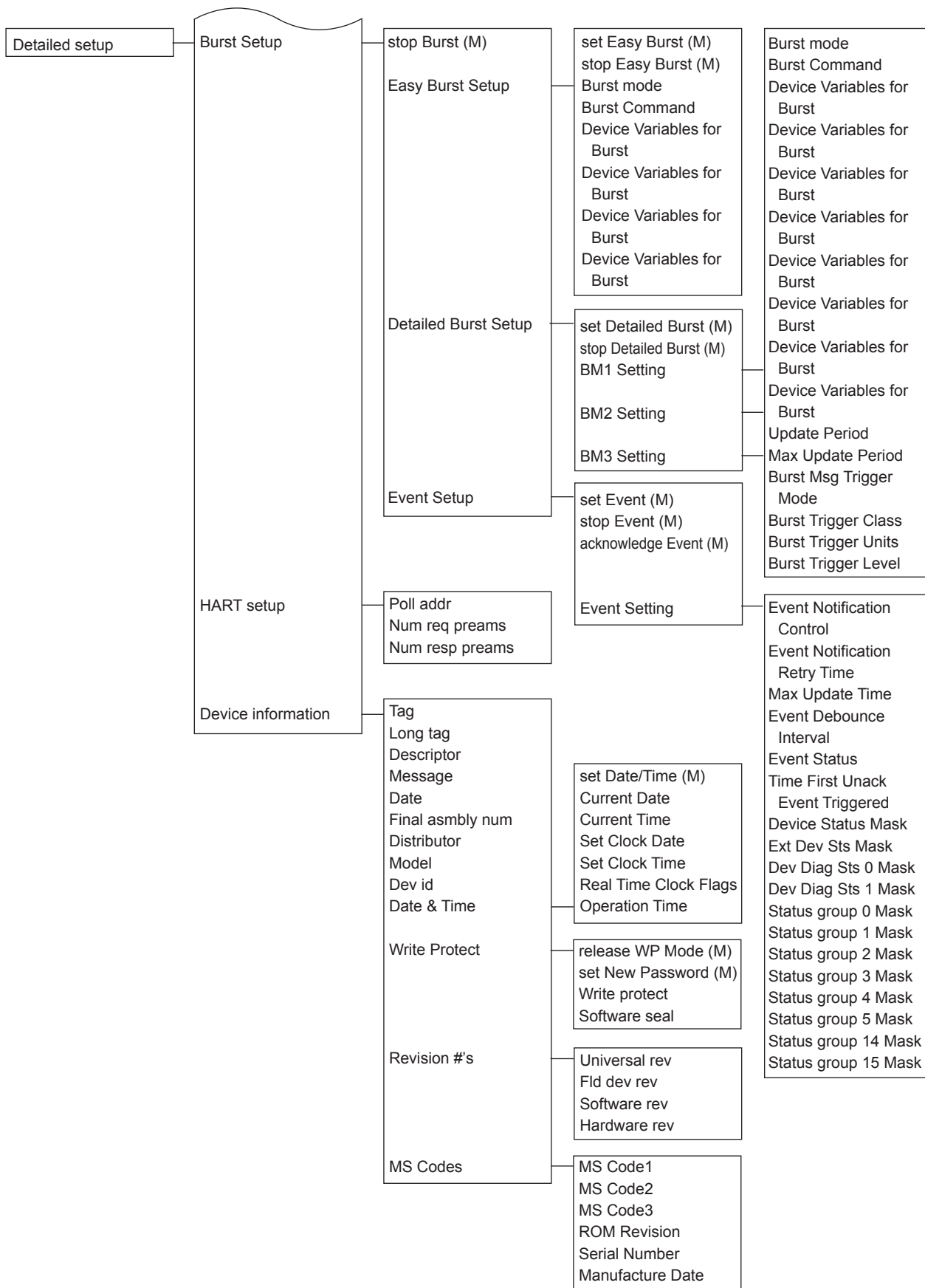

F0301-8.ai

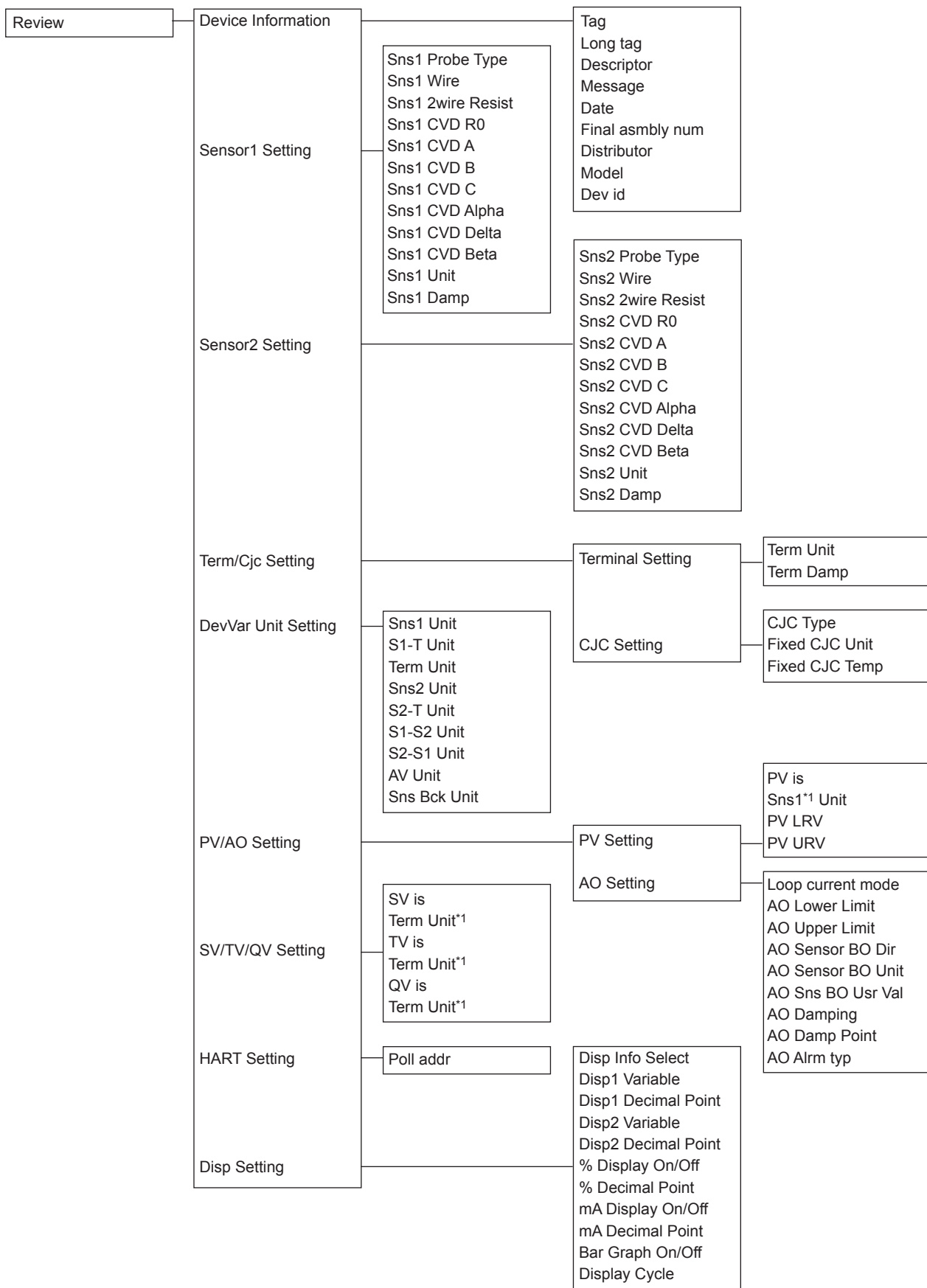

*1: Parameter depends on the process variable mapping.

3.2 Parameter Description

The followings outline the functions of the HART parameters for YTA.

- **Review (→ 3.3)**
Before starting operation, review all the configuration of the transmitter to confirm that it meets the current application.
- **Sensor Configuration (→ 3.4.1)**
When changing the sensor type from the current setting to another, it is necessary to change some parameter settings.
- **Process variable mapping (→ 3.4.2)**
Process variable is to be assigned as primary (PV), secondary (SV), tertiary (TV) and fourth (QV) Variable and can be monitored on the Integral indicator or Handheld terminal. Primary variable (PV) is output as the 4 to 20mA analog signal.
- **Unit (→ 3.4.3)**
Choose the engineering unit for the process variables assigned as PV,SV, TV, QV and the device variables from °C, Kelvin, °F and °R .
When mV or ohm is specified as an input type, the unit is automatically set as mV or ohm.
- **PV Range (→ 3.4.4)**
Change the range of PV to be output as the 4 to 20mA DC. There's two ways to set the range value.
<a> Setting by keypad Setting by applying value
- **Damping time constant (→ 3.4.5)**
Setting the response time of the transmitter smooths the output with rapid changes in input.
- **Device Information (→ 3.5.1)**
Set data in Tag, Message, and Descriptor parameters.
- **Test Output (→ 3.5.2)**
Make the transmitter output a fixed current from -2.5 through 110 % in 0.1% increments for loop checks.
- **Burnout Function (→ 3.5.3)**
Configure the current output value in sensor failure. Select from High, Low and User setting value.
- **Integral Indicator Display Mode (→ 3.5.4)**
To change items to be displayed on the Integral Indicator.
- **Write Protect (→ 3.5.5)**
To enable / disable write protection of parameters.
- **Sensor trim (→ 3.5.6)**
The trim adjustment function allows the user to add a compensation to the factory set characterization curve to more closely match the input signal.
- **Analog Output trim (→ 3.5.7)**
Adjust the output value.
- **Sensor Backup Function (→ 3.5.8)**
Configure a transmitter to automatically transfer the input from Sensor1 to Sensor2 when Sensor1 fails.
- **Burst Mode (→ 3.5.9)**
In the burst mode, a transmitter continuously sends a selected set of data.
- **Multidrop Mode (→ 3.5.10)**
Up to 63 transmitters can be connected when set in the multidrop mode.
- **Sensor Matching Function (→ 3.5.11)**
This function is available only when optional specification /CM1 is specified.
- **CJC Selection (→ 3.5.12)**
For thermocouple input, the terminal temperature measured by an internal sensor is used for Cold Junction Compensation function.
- **TC User Table (→ 3.5.13)**
This function enables users to calculate temperature by creating their own table for TC sensors for the conversion between temperature and electromotive force.
- **Simulation (→ 3.5.14)**
Using the simulation function, the output signal can be confirmed by setting any value and status to the selected device variable. Test device variable and Test status are available.
- **Squawk (→ 3.5.15)**
This feature can be used to identify the communicating transmitter by remotely causing LCD to display the particular pattern.

3.3 Review

Before starting operation, review all the configuration of the transmitter to confirm that it meets the current application.

Select Device Set up → Review. Parameters are grouped by type and listed in review display of each group. Call up each review display, and scroll through the list to check each variable. If a change is necessary, refer to the “3.4 Basic Setup” and “3.5 Detailed Setup” in this manual.

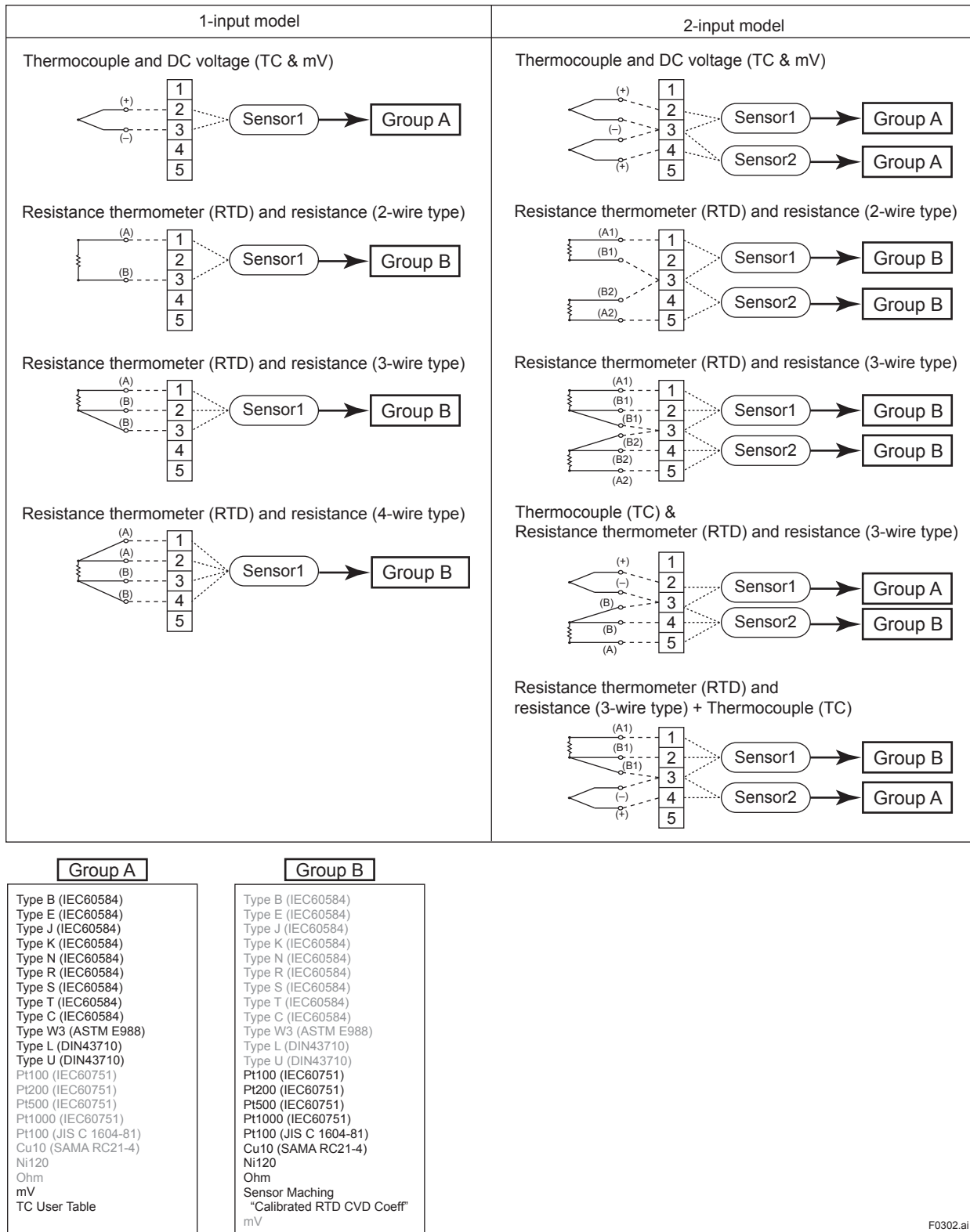

F0302.ai

Figure 3.1 Wire connection and sensor type

3.4 Basic Setup

3.4.1 Sensor Configuration

When changing sensor type, it is necessary to change the parameters related to the sensor type. Figure 3.1 shows the wire connections to the input terminals of the transmitter and sensor type selections for the parameters in each connection case. Note that TCs and mV are categorized as Group A and RTDs and ohm are as Group B. Check the connections between the input terminals and temperature sensors and set the correct sensor type and the number of wire connections for the parameters.

The setting method is as described below.

(1) Selecting the sensor type/Setting the number of wires

- Procedure to call up the display
Device setup → Basic setup → Sensor Basic Setup → Sensor1 Basic Setup → set Sns1 Probe (M)
Set the sensor probe type and set the number of wires according to the message on display.

(2) Setting the sensor unit

- Set the sensor unit.
- Procedure to call up the display
Device setup → Basic setup → Sensor Basic Setup → Sensor1 Basic Setup → Sensor1 Others → Sns1 Unit



NOTE

In case of 3 wire RTD or ohm connection, if actual connection and connection setting is imbalance, unforeseen alarm may be generated.

3.4.2 Process Variable Mapping

Process variable can be assigned as primary (PV), secondary (SV), tertiary (TV) or fourth (QV) variable and can be monitored on Integral indicator or Handheld terminal. The primary variable (PV) is output as a 4 to 20mA analog signal, and thus it is necessary to map the variable as PV. Other variable can be left as "Terminal" when they are not required. Configuration of Sensor 1 (and Sensor 2) must be done before changing the process variable mapping. (See 3.4.1)

Call up the "Device Variables" display and carry out the process variable mapping to PV, SV, TV, and QV.

- Procedure to call up the display
Device setup → Process variables → Dynamic Variables → PV (SV, TV or QV) → PV (SV, TV or QV) is
Set process variables below.
Sensor1: Sensor1 input
Sensor1-Terminal: Temperature difference between sensor1 input and terminal temperature
Terminal: Terminal temperature
Sensor2: Sensor2 input
Sensor2-Terminal: Temperature difference between sensor2 input and terminal temperature
Sensor1-Sensor2: Difference between sensor1 input and sensor2 input
Sensor2-Sensor1: Difference between sensor2 input and sensor1 input
Average: Average of sensor1 input and sensor2 input
Sensor Backup

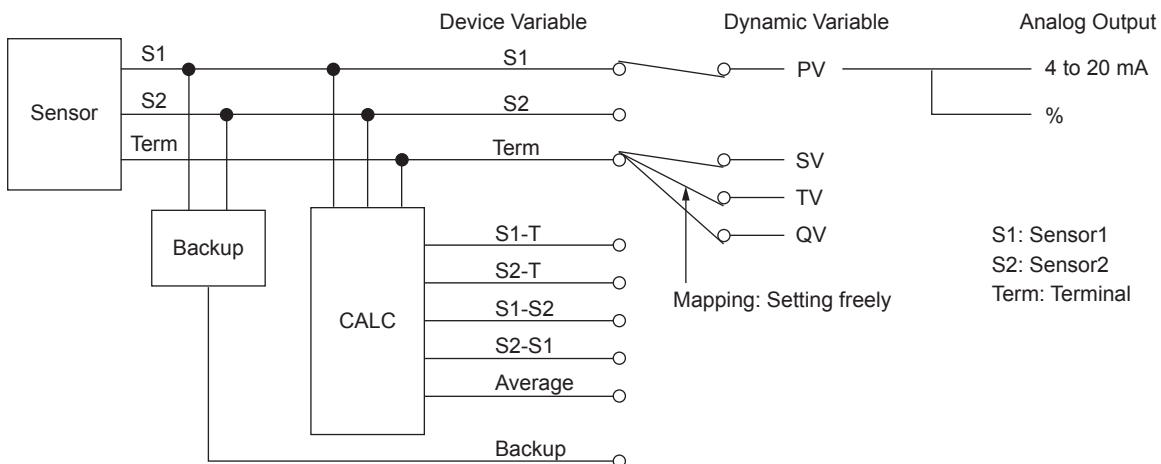

Figure 3.2 Process variable mapping

F0303.ai



NOTE

- When “Sensor1-Sensor2”, “Sensor2-Sensor1”, “Average”, “Sensor1-Terminal”, or “Sensor2-Terminal” is selected, the sensor types to be set for Sensor1 and Sensor2 should be selected from any one of the following three groups; Temperature sensor (T/C and RTD), DC voltage or resistance. The combination (for example, temperature sensor and DC voltage input) would cause an incorrect computation due to the different unit system and is not allowed.
- When “Sensor1-Terminal” or “Sensor2-Terminal” is selected, Temperature sensor should be set for Sensor1 or Sensor 2.

3.4.3 Unit

The unit for PV is set at the factory before shipment. When Sensor1 (or Sensor2) or Terminal temperature is mapped as PV, SV, TV or QV, the unit that is selected for Sensor1 (or Sensor2) or Terminal temperature is automatically referred as a unit for these process variables. (See 3.4.1 Sensor Configuration) When PV, SV, TV, or QV unit is set , the unit is set the sensor value unit mapped PV, SV, TV, or QV automatically.

- Procedure to call up the display.
Device setup → Process variables → Device Variables
→ Sensor1 → Sns1 Unit
→ Sensor2 → Sns2 Unit
→ Terminal → Term Unit
Set the Unit
- Procedure to call up the display.
Device setup → Process variables → Dynamic Variable → PV (SV, TV or QV)
Set the Unit
When process variable is mV input, unit is automatically selected mV and ohm input, unit is automatically selected ohm.



NOTE

When PV is changed from Sensor1 to Sensor2, PV unit is automatically changed from Sensor1 unit to Sensor2 unit.

3.4.4 PV Range

The range for PV corresponding to the 4 to 20mA output signal is set at the factory before shipment. Followings are the procedures to change the range.

(1) Changing the range with Keypad – LRV, URV –

Setting LRV and URV

- Procedure to call up the display
Device setup → Basic setup → PV Basic Setup → PV Re-range → Range values
Set the LRV and URV.



NOTE

It is possible to set LRV>URV.

This setting reverses the 4 to 20 mA output signal.

Setting Conditions:

$$LSL \leq LRV \leq USL$$

$$LSL \leq URV \leq USL$$

$$|URV - LRV| \geq \text{Recommended Min. span}$$

(2) Changing the range while applying an actual input – Apply values –

- Procedure to call up the display
Device setup → Basic setup → PV Basic Setup → PV Re-range → Apply values
- Apply the input corresponds to 4mA.
- After obtaining stable input, determine the 4mA output.
- Select 20mA and set same as 4mA setting.

3.4.5 Damping Time Constant

(1) Setting the device variable damping

Setting the response time of each process variable makes it very slowly with a rapid change in input. Set the value from 0 to 100 seconds. If the time constant is set to 2 seconds, transmitter calculates a reading every cycle time using the damping equation, to make the output 63 percent of the input range after 2 seconds.

This damping time constant is normally set to work when the temperature makes a step change within 2 percent of the output range. Following are the procedures to change the damping time constant of Sensor1.

- Procedure to call up the display
Device setup → Basic setup → Sensor Basic Setup
→ Sensor1(2) Basic Setup → Sensor1(2)
Others → Sns1(2) Damp
→ Term Basic Setup → Term Damp
Set the damping time constant.

(2) Setting the analog output damping

Damping time constant of analog output can be set.

- Procedure to call up the display
Device setup → Basic setup → AO Basic Setup
→ AO Damping
Set the damping time constant.

(3) Setting the damping threshold of analog output

Set the % of the output range. When the amount of variation is larger than the set value, it does not perform the dumping process. (Only for analog damping) This damping time constant is normally set to work when the temperature makes a step change within 2 percent of the output range upon factory shipping. Following are the procedures to change the damping threshold.

- Procedure to call up the display
Device setup → Basic setup → AO Basic Setup
→ AO Damp Point
Set the damping threshold.

Output change in case of AO Damp Point is 10% (Range: 0 to 100°C)

Input variation is 10% or less Input variation is 10% or more

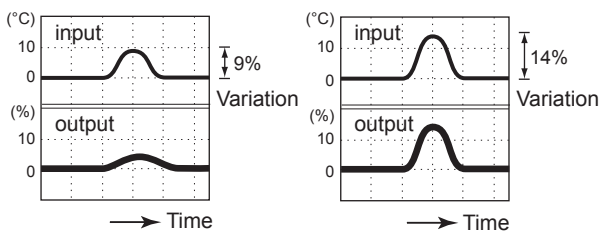

Figure 3.3 Output change with damping



NOTE

Refer to the Figure 3.3 about the relation between Sensor1 (2) and AO Damp/AO Damp point.

3.5 Detailed Setup

3.5.1 Device Information

Following device information can be set by below procedures.

- Procedure to call up the display
Device setup → Detailed setup → Device information
Set the device information.
→ Tag: Up to 8 characters
→ Long Tag: Up to 32 characters
→ Descriptor: Up to 16 characters
→ Message: Up to 32 characters
→ Date

3.5.2 Test Output

(1) Loop Test

This feature can be used to output a fixed current from 3.6 mA (-2.5%) to 21.6 mA (110%) for loop checks.

- Procedure to Call up the “exec Loop Test” parameter
Device setup → Diag/Service → Test Device → exec Loop Test
Select below.
4mA: Outputs 4 mA current
20 mA: Outputs 20 mA current
Other: Sets a desired output in mA using alphanumeric keys.
End: Exits



IMPORTANT

- Test output is held for approximately 10 minutes (depends on Auto Release Time setting), and then released automatically after the time has elapsed. If the HART communicator power supply is turned off or communication connector is disconnected during the test output operation, it is held for approximately 10 minutes.
- Select “End” to release the test output immediately.
- If the temperature transmitter power supply is turned off, test output is released.
- If you abort the method by pressing the close button at the top right corner of the dialog during the method is still running, you may not be able to return to normal. If you abort the method by this procedure, please re-run the method and return to normal.

(2) Auto Release Time

This parameter can be used to set the auto release time of Loop Test and Simulation (See 3.5.14).

- Procedure to call up the display
Device setup → Diag/Service → Test Device → Auto Release Time
Select from 10 minutes, 30 minutes, 60 minutes, 3 hours, 6 hours or 12hours.
Default setting is 10 minutes.



NOTE

If the transmitter is equipped with the integral indicator, the LCD displays F.O.

3.5.3 Burnout Function

(1) Sensor burnout

Configure the burnout mode in the case of sensor failure or disconnection.

- Procedure to call up the display
Device setup → Basic setup → AO Basic Setup → AO Sensor BO Dir: Select High, Low, User Config or Off.
→ AO Sensor BO Unit: Select mA or %
→ AO Sns BO Usr Val: Outputs user set value within 3.6 to 21.6 (mA) or -2.5 to 110 (%)
When the sensor failure is detected, the transmitter outputs one of the following values.
Low: Outputs 3.6mA
High: Outputs 21.6mA
User (mA): Outputs user set value in mA. Settable within 3.6 to 21.6 mA.
User (%): Outputs user set value in %. Settable within -2.5 to 110 %.
Off: The burn out output is NOT defined



NOTE

When sensor burnout is set to “off”, the transmitter’s output will go undefined at sensor failure. It is necessary to understand this point well when setting “off”.

During sensor burn out time, any of AL.09, AL.10 to 13 or AL.22 alarm message is generated. (See Chapter 4 for details.)

(2) Burnout in hardware failure

The output status of the transmitter in hardware failure is set using a slide switch on the MAIN assembly. The current setting can be checked in parameter “PV Alm type”.

- Procedure to call up the “AO Alm type parameter” display
Device setup → Basic setup → AO Basic Setup → AO Alm typ
Hi: More than 110% output (21.6mA)
Lo: Less than -5% output (3.2mA)

3.5.4 Integral Indicator Display Mode

When an integral indicator is specified with the transmitter, the display items and display cycle can be configured.

(1) Process Variable Display

Process variables that can be displayed in YTA are shown in the Table 3.1. A cycle of up to four displays (Disp Out1, Disp Out2, Disp %, Disp mA) can be shown by assigning variables to the parameters. Indicate values of process variables with the indication limits -99999 to 99999.

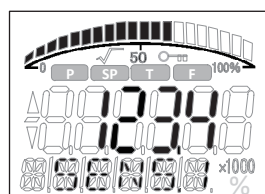

F0305.ai

Table 3.1 Process Variable Display

Process variable	Disp Out1	Disp Out2
Sensor1	✓	✓
Sensor1 – Terminal	✓	✓
Terminal	✓	✓
Sensor2	✓	✓
Sensor2 – Terminal	✓	✓
Sensor1 – Sensor2	✓	✓
Sensor2 – Sensor1	✓	✓
Average	✓	✓
Sensor Backup	✓	✓
PV	✓	✓
SV	✓	✓
TV	✓	✓
QV	✓	✓
Not used	—	✓

(2) Display Selection

- Procedure to call up the display
Device setup → Detailed setup → Display Setup
→ Disp1 Variable: Select from Table3.1.
→ Disp2 Variable: Select from Table3.1.
→ % Display On/Off: Select On/Off.
→ mA Display On/Off: Select On/Off.
→ Bar Graph On/Off: Select On/Off.

(3) Display Resolution

- Procedure to call up the display
Device setup → Detailed setup → Display Setup
→ Disp1 Decimal Point
→ Disp2 Decimal Point
→ % Decimal Point
→ mA Decimal Point
Select the decimal point from 0, 1, 2 or 3.

(4) Setting Display Cycle

- Procedure to call up the display
Device setup → Detailed setup → Display Setup → Display Cycle
High: 1.2 seconds
Mid (Default): 2.4 seconds
Low: 3.6 seconds

(5) Display Information

Following information is displayed on lower level of the display.

- Procedure to call up the display
Device setup → Detailed setup → Display Setup → Disp Info Select
Process variable name: Parameter
Process variable unit: Unit
Status of process variable: Status
Sensor type: Sensor Type
Number of wiring: Sensor Wire

3.5.5 Write Protect

(1) Software write protect

The transmitter configured data is saved by using a write protection function. The write protection status is set to “Yes” when 8 alphanumeric characters are entered in the New password field and transferred to the transmitter. When write protection is set to “Yes,” the transmitter does not accept parameter changes. When the same eight alphanumeric string

entered in the New password field is also entered in the Enable wrt 10 min field and transferred to the transmitter, it will be possible to change transmitter parameters during a 10 minute period. To change the transmitter from the write protection “Yes” status back to write protection “No” status, use Enable wrt 10min to first release the write protection function and then enter eight spaces in the New password field.

- Procedure to call up the display
Device setup → Detailed setup → Device information → Write Protect
→ Write protect: Display current write protect mode (Yes: protected, No: not protected)
→ release WP Mode: Release the write protect function for 10 min.
→ set New Password: Set the new password or change the password.

(2) Software seal

When the joker password has been used to release write protection, this parameter displays “Break,” and when protection is cancelled using the password set using “set New Password”, it returns to “Keep.”



NOTE

If you should forget your password, the joker password can be used to temporarily release write protection function. To obtain the joker password, please contact your nearest YOKOGAWA sales office.

(3) Hardware write protect

See IM 01C50G01-01EN, section 3.2 “Hardware Error Burnout and Hardware Write Protect Switch.”

3.5.6 Sensor Trim

Each YTA transmitter is factory-characterized based on the standard sensor curve, and uses this information to produce a process variable output. The sensor trim function is used to make an adjustment to the internal interpretation of the input signal and the factory characterization in the transmitter. (See Figure 3.4) Since the factory characterization is kept even after applying the trim operation, it is possible to recover factory characterization.

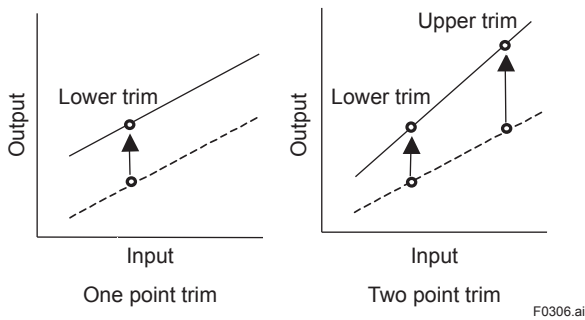

Figure 3.4 Trim function images

● **Procedures (For Sensor1)**

Before performing the sensor trim, complete the configuration of the sensor input.

- a) Connect the calibration device to the transmitter and warm-up for 3 minutes.

a. Wiring of power supply and output

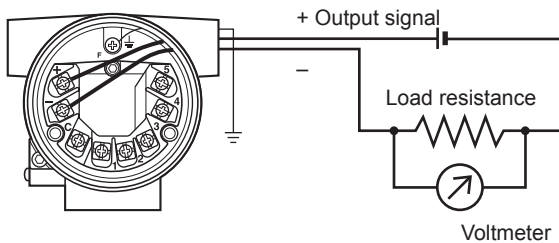

b. Example of wiring of thermocouple or DC voltage input (1-input type)

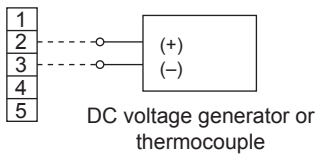

c. Example of wiring of thermometer resistor 4-wire type (1-input type)

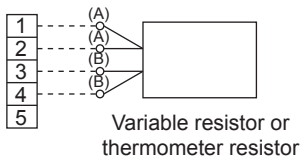

Figure 3.5 Example of wiring for calibration equipment

- b) Apply lower input to Sensor1.
- c) Procedure to call up the display
Device setup → Diag/Service → Calibration → Sensor trim → Sensor1 Trim → set Sensor1 Trim
- d) Select the sensor (Sensor1) to be trimmed.
- e) Select the Lower trim only or the Lower & Upper Trim.

- f) Sensor1 temperature is displayed. If the value is OK, press OK. If the display value is different from the expected value, enter the expected value.

Example: In case of the temperature of the Sensor1 indicates the 1°C and expected temperature is 0°C, enter 0°C.

- g) Next carry out the Upper trim. Apply Upper input to Sensor1.
- h) Carry out the Upper Trim same as the Lower Trim procedures.



NOTE

“reset Sensor1 Trim” can reset the user’s trim adjustment to the initial calibrated values.

3.5.7 Analog Output Trim

Fine current output adjustment is carried out with AO trim.

AO trim is to be carried out if the calibration digital ammeter does not exactly read 4.000 mA and 20.000 mA with an output signal of 0% and 100%.

- Procedure to call up the AO trim display
Device setup → Diag/Service → Calibration → AO Trim → set AO Trim

Follow the message to adjust analog output.



IMPORTANT

If you abort the method by pressing the close button at the top right corner of the dialog during the method is still running, you may not be able to return to normal. If you abort the method by this procedure, please re-run the method and return to normal.

3.5.8 Sensor Backup (For dual input type only)

The sensor backup function sets the transmitter to automatically use Sensor2 as output if Sensor1 fails. When the sensor backup mode is activated, map Sensor backup as PV. If sensor1 fails, the transmitter starts Sensor Backup operation and Sensor2 is output in place of Sensor1 to PV. There’s no disruption in 4 to 20 mA output. Alarm message “Backup Sns1 Fail” is sent to the integral indicator and HART communicator. In backup

operation, even if the Sensor1 recovers, the transmitter will continue to use Sensor2 until the backup operation is reset by parameter or power is turned off. If Sensor2 fails during backup operation, the transmitter will send “Backup Sns2 Fail” to the integral indicator and HART communicator and output the “Sensor burnout” value.

• **Specifications**

Specifications: Dual input only

Sensor Type: Any type available

But two sensors should be same type.

Sensor value: Display in Backup

(1) To enable Sensor backup function

- a) Set the sensor type, wire and unit for Sensor1 and 2. (See 3.4.1) Any Sensor type except “Non-connection” can be selected.
- b) Map the Sensor Backup as PV.
- c) Set the sensor burnout type to High, Low or user setting value. If the sensor burnout type is set to “off”, the sensor failure will not be detected and the backup function will not act.

- (2) To make the transmitter return to using Sensor1 in Backup Operation
 - a) Confirm that the Sensor1 is recovered
 - b) Procedure to call up the display
Devise setup → Detailed setup → Sensor Setup → Sensor Backup → recover Sensor
 - c) Confirm that Sensor Backup State is “Sensor1 Active”.

3.5.9 Burst Mode

When the Burst mode is enabled, the transmitter continuously sends up to three data listed in Table 3.2. When the Burst mode is set to “ON”, transmitter continuously sends alarm signal also. When changing the setting of Burst mode, set “Off” to the Burst mode. Default setting is “Off”.

Table 3.2 Burst Parameters

Command Parameter	Burst Command	Burst Msg Trigger Mode	Burst Trigger Source	Burst Trigger Units
PV	Cmd1: PV	Continuous	—	Depend on the assigned variable to PV
		Window	PV	
		Rising		
		Falling		
		On-change		
Loop Current and Percent Range	Cmd2: % range/current	Continuous	—	%
		Window	% range	
		Rising		
		Falling		
		On-change		
PV, SV, TV, QV	Cmd3: Dyn vars/current	Continuous	—	Depend on the assigned variable to PV
		Window	PV	
		Rising		
		Falling		
		On-change		
Device Variable	Cmd33: Device vars	Continuous	—	—
		Window	Top of Burst Device Variable	
		Rising		
		Falling		
		On-change		
Device Variable with status	Cmd9: Device vars w/status	Continuous	—	—
		Window	Top of Burst Device Variable	
		Rising		
		Falling		
		On-change		
Additional Device status	Cmd48: Read Additional Device Status	Continuous	—	—
		On-change	All status	—

(1) Burst Message and Burst Mode

The transmitter can transmit three burst messages at the maximum. The parameters for Burst Message are as follows.

- Burst Command
 - Update Period and Max Update Period
 - Burst Msg Trigger Mode
- a) Burst Command
Select the transmission data at Burst Command parameter.

Burst Command	Command parameter
Cmd1: PV	PV
Cmd2: % range/current	Loop Current and Percent Range
Cmd3: Dyn vars/current	PV, SV, TV, QV
Cmd33: Device vars	Device Variable
Cmd9: Device varsw/status	Device Variable with status
Cmd48: Read Additional Device Status	Additional Device status

- b) Burst Variable Code/Device Variable Code
This parameter need to be set when Burst Command is Cmd9: Device vars w/status (up to eight items) or Cmd33: Device vars (up to four items).
- c) Update period and Max Update Period
Set to Update Period and Max Update Period. When the period that is earlier than the operation period of each process value was set, it is set automatically to become bigger than an operation period of the transmitter. For Update Period, set the value that is smaller than Max Update Period.
- d) Burst Msg Trigger Mode
Set the Burst Msg Trigger Mode from the parameters shown below. When Burst Msg Trigger Mode is window, Rising or Falling, set the Burst Trigger Level.

Display Item	Contents
Continuous	Burst Message is transmitted continuously.
Window	In "Window" mode, the Trigger Value must be a positive number and is the symmetric window around the last communicated value.
Rising	In "Rising" mode, the Burst Message must be published when the source value exceeds the threshold established by the trigger value.
Falling	In "Falling" mode, the Burst Message must be published when the source value fall below the threshold established by the trigger value.
On-change	In "On-change" mode, the Burst Message must be published when the source value on change established by the trigger value.

- e) Burst Mode
When the Burst mode is set to Enabled, the transmitter starts to send the data.

(2) Procedure to set the Burst Mode

- a) Easy Burst Mode
This function can send only one parameter continuously.
- Procedure to call up the display
Detailed setup → Burst Setup → Easy Burst Setup → set Easy Burst
Set Command Parameter according to the method.
- b) Detailed Burst Mode
This function can send up to the three parameters with various conditions.
Detailed setup → Burst Setup → Detailed Burst Setup → BM1(or 2,3) Setting
→ set Detailed Burst
Applicable setting parameters:
Burst Command
Update Period and Max Update Period
Burst Msg Trigger Mode

(3) Event Notification record

This function detects setting change and a change of the Self-diagnostics as event and can transmit alarm signal continuously. Up to five events that occurred can be stored. When using this function, set to any of the Burst Message of “Detailed Burst Mode” to ON,

(3-1) Set Event Notification

Setting parameter for event notification is listed below. Set these parameters according to the method.

- Device status that detects event (Event Mask)
- Transmission interval
 - Event Notification Retry Time
 - Max Update Time (In case of no event)
 - Event Debounce Interval
- Procedure to call up the display
 - Detailed setup → Burst Setup → Event Setup → set Event
 - Set above parameters according to the method.

(3-2) Stop Event Notification

This function stops the event notification.

- Procedure to call up the display
 - Detailed setup → Burst Setup → Event Setup → stop Event
 - Stop the Event Notification according to the method.

(3-3) Acknowledge Event Notification

This function acknowledges the Event notification.

- Procedure to call up the display
 - Detailed setup → Burst Setup → Event Setup → Acknowledge Event
 - Acknowledge the Event Notification according to the method.

(3-4) Event Notification Function Flow

When the Event Notification is enabled, a status change caused by the self-diagnosis of the equipment will alarm Event1. Event1 is continuously transmitted at the Retry Time interval until Event1 is acknowledged. If Event1 is acknowledged, Event1 disappears. Status which is acknowledged the last is continuously transmitted at the Max Update Time interval. If the other status change occurred before Event1 acknowledgement, Event2 keeps internal and Event1 is continuously transmitted. Acknowledgement is carried out in this state, Event1 is disappeared and Event2 is transmitted. In addition the acknowledgement is carried

out, all events are disappeared. Status which is acknowledged the last is continuously transmitted at the Max Update Time interval.

3.5.10 Multidrop Mode

“Multidropping” transmitters refer to the connection of several transmitters to a single communication transmission line. Up to 63 transmitters can be connected when set in the multidrop mode. To activate multidrop communication, the transmitter address must be changed to a number from 1 to 63. If it sets to multidrop mode, in order to transmit all the data in digital one, it is necessary to change a setup of the analog output signal of 4 to 20 mA.

Setting of Multidrop Mode

(1) Polling address

- Procedure to call up the display
 - Device setup → Detailed setup → HART setup → Poll addr: Enter the number from 1 to 63.



NOTE

When the same polling address is set for two or more transmitters in multidrop mode, communication with these transmitters is disabled.

(2) Analog Output Signal Setting

Set Disabled to Loop current mode and fix an analog output signal to 4mADC. It becomes impossible in this case, to also use a burnout output. However, in the case of the application which receives and operates an analog output signal, an analog output signal can be used for one loop. In this case, set Enabled to Loop current mode.

- Procedure to call up the display
 - Device Setup → Detailed Setup → AO Setup → AO Basic Setup → Loop current mode → Enabled: Loop current mode is enabled (4 to 20mA output)
 - Disabled: Loop current mode is disabled (4mA fixed)

(3) Enabling the Multidrop Mode of Configuration Tool

About the procedure to call up the Polling display, please refer to the User’s Manual of each configuration tool.

(4) Communication when set in multidrop mode

- The HART configuration tool searches for a transmitter that is set in multidrop mode when it is turned on. When the HART configuration tool is connected to the transmitter, the polling address and the tag will be displayed.
- Select the desired transmitter. After that, normal communication to the selected transmitter is possible. However, the communication speed will be slow.

(5) Release the multidrop mode

To release multidrop mode, call up the Poll addr display and set the address to "0." Return Loop current mode to Enabled.

3.5.11 Sensor Matching Function

This function is available only when optional specification /CM1 is specified. Significant temperature measurement accuracy improvement can be obtained using a temperature sensor that is matched to a transmitter.

(1) Sensor Matching function

Applicable sensors: Pt100, Pt200, Pt500 and Pt1000
 The properties of the RTD sensor for the YTA comply with the standard specified in IEC60751. Although their variations are within the range allowed by the standard, they may cause measurement errors. The Sensor Matching function improves the precision of temperature measurement by programming the Callendar-Van Dusen constants, specific numbers defined for each RTD sensor, into the transmitter.



NOTE

Before setting the Sensor Matching function, perform the Sensor Type to "Calibrated RTD". (see 3.4.1)

The following relation exists between the resistance (Rt) of a RTD sensor and the temperature (t) at that time.

$R_t = R_0 \{1 + \alpha(1 + 0.01\delta)t - \alpha\delta/10^4 t^2 - \alpha\beta/10^8 (t - 100)t^3\}$
 where: Rt=Resistance (ohms) at Temperature t (°C)
 R0=Sensor -specific constant (Resistance at t=0°C)
 α (alpha)=Sensor-specific constant
 δ (delta)=Sensor-specific constant
 β (beta)=Sensor-specific constant
 (0 at t>0°C)

Although the sensor curve is standardized, the exact values for R0, α, δ and β are specific to each RTD sensor and are obtained by testing each individual sensor at various temperatures. These constants are known as Callender-van Dusen constants. Generally, the constants R0, A, B, and C are also used as the characteristic coefficients of the RTD instead of R0, α, δ and β. These are derived from IEC Standard Curve and the relationship is described as followings;

$R_t = R_0 \{1 + At - Bt^2 + C (t - 100) t^3\}$

where: Rt=Resistance (ohms) at Temperature t (°C)

R0 = Sensor-specific constant (Resistance at t=0°C)

A = Sensor-specific constant

B = Sensor-specific constant

C =Sensor-specific constant (0 at t > 0°C)

These two equations are equivalent. A model YTA can cope with either case as above-mentioned.



IMPORTANT

Note the following restrictions when inputting values for the R0, α, δ, β, A, B, and C constants in the YTA.

- Values must be normalized ones with an exponential part determined for respective constants (see the table below).
- Values must be rounded off so that they have the digits after the decimal point determined for respective constants (see the table below).
- Values with three digits after the decimal point may be changed to values with four digits after the decimal point, which are equivalent to the original value when rounded off.

Example: +3.809 E-3 → +3.8089 E-3

Item	Decimal point	Exponent	Example	Initial setting
R0	2	non	+100.05	+100
A	3	E-3 (10 ⁻³)	+3.908 E-3	+3.9083 E-3
B	3	E-7 (10 ⁻⁷)	-5.802 E-7	-5.7749 E-7
C	3	E-12 (10 ⁻¹²)	-0 E-12	-4.183 E-12
α	3	E-3 (10 ⁻³)	+3.850 E-3	+3.8505 E-3
δ	3	E0 (10 ⁰)	+1.507 E0	+1.4998 E0
β	3	E-1 (10 ⁻¹)	+0 E-1	+1.0862 E-1

**IMPORTANT**

- This function is effective only in four kinds of sensors; Pt100, Pt200, Pt500 and Pt1000.
- Input relations between the sensor type and the value of R0 properly. When Pt100 is specified as an input type, the value close to 100 must be set to R0. When Pt500 is specified as an input type, the value close to 500 must be set to R0.
- When the sensor type is changed, the sensor matching function must be set up again.

- a) Setting the Sensor Matching Function
- 1) Device setup → Basic Setup → Sensor Basic Setup → Sensor1 Basic Setup → set Sns1 Probe(M)
Set the sensor type to “calibrated RTD” and the number of wires.
 - 2) Procedure to call up the display.
Device setup → Basic setup → Sensor Basic Setup → Sensor1 Basic Setup → Sensor1 Probe Setup → set Sns1 Matching
Set the Sns1 Matching and set the co-efficient according to the message.
- b) For Setting up two sensors
- If using the sensor2, repeat the procedures for the Sensor1.
- Procedures to call up the display
Device setup → Basic setup → Sensor Basic Setup → Sensor2 Basic Setup → Sensor2 Probe Setup → set Sns2 Matching

**NOTE**

When the co-efficient of sensor matching is set incorrectly, inverse calculation alarm may be generated.

3.5.12 CJC Selection

For thermocouple input, the terminal temperature measured by an internal sensor is used for Cold Junction Compensation function. In YTA, constant value set by users can be used for the compensation function in place of the measured terminal temperature.

- a) Procedure to call up the parameter “CJC”
Device setup → Basic setup → Sensor Basic Setup → CJC Setup → set CJC Type
Set the CJC type and set the CJC function by following the message shown.
In case of using Terminal temperature, select “Internal CJC Temperature Measurement”.
In case of using constant value set by users, select “Fixed CJC Temperature”.

3.5.13 TC User Table

This function enables users to calculate temperature by creating their own table for TC sensors for the conversion between temperature and electromotive force.

Specifications

Number of tables: 1 (common for Sensor1 and Sensor2)

Sensor type: TC User Table (TC only)

Input items: Temperature and electromotive force

Number of valid points: 5 to 50 points

Input the values of temperature and electromotive force in ascending order from the top of the table. This function determines the end of the table as being where the value of either temperature or electromotive force is not in ascending order.

Measuring range: -10 to 120 mV

How to input: Only from DTM, using FieldMate as a setting tool

- Procedure to set up the function
From menu bar of the DTM works window, click “Device” → “Additional Functions” → “TC User Table”
Set the valid points and unit and fill in the Temperature and Electromotive force table.

**NOTE**

Before setting the TC User Table, perform the Sensor Type to “TC User Table”.
(see 3.4.1)

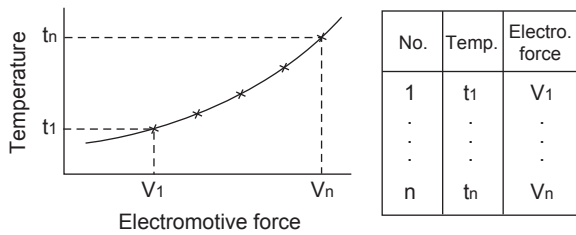

Note: Interpolating between valid points in the quadratic equation.

F0308.ai

Figure 3.6 TC user's table



NOTE

When the TC user table is set incorrectly, reverse calculation alarm may be generated.

3.5.14 Simulation

Using the simulation function, the output signal can be confirmed by setting any value and status to the selected device variable. Call up the parameter and follow the message shown.

After completing "(2) Test status" setting, the simulation starts. Integral indicator shows output value.

(1) Test device variable

- Procedure to call up the display
Device setup → Diag/Service → Test Device → Device Variable Test
→ enable Dev Var Sim or disable Dev Var Sim
Set the parameters according to the method.

(2) Test status

- Procedure to call up the display
Device setup → Diag/Service → Test Device → Device Status Test
→ en/ds Dev Sts Sim
Set the parameters according to the method



IMPORTANT

- Test output is held for approximately 10 minutes (depends on Auto Release Time setting), and then released automatically after the time has elapsed. If the HART communicator power supply is turned off or communication connector is disconnected during the test output operation, it is held for approximately 10 minutes.
- Select "Disable" to release the test output immediately.
- If the temperature transmitter power supply is turned off, test output is released.

3.5.15 Squawk

This feature can be used to identify the communicating transmitter by remotely causing LCD to display the particular pattern as shown in the Figure 3.7.

- Procedure to call up the Squawk display
Device setup → Diag/Service → Test Device → exec Squawk
Select On, Off or Once.
Once: "SQUAWK" continues for approximately 15 seconds, then is released automatically.

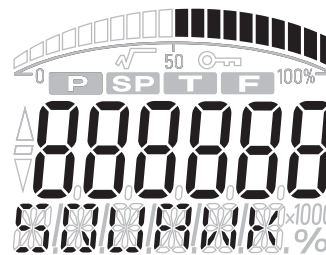

F0309.ai

Figure 3.7 LCD Display for Squawk

4. Diagnostics

4.1 Self-Diagnostics

The YTA monitors its own performance during operation. Upon detecting any abnormality, the YTA displays and records the abnormality in parameters, outputs out-of-range values, and in the case of a type with an integral indicator, it displays an alarm number corresponding to the abnormality.

4.1.1 Checking for Problems

(1) Identifying Problems with the HART Communicator

Self-diagnostics of the transmitter and check of incorrect data settings can be carried out with the HART communicator. There are two methods for self-diagnosis of the transmitter; self-diagnosis for every transmission and manually executing the Self test command.

When an alarm message appears, see Table 4.1 “List of Alarms” for details.

- a) Procedure to call up the display
- b) Device setup → Diag/Service → Test Device → exec Self test
Select “Perform”
- c) If there is no alarm detected, “Self test OK” will be displayed. When an alarm occurs, an alarm message appears, and the results of self-diagnostics appear in the Status item.
- d) Procedure to call up the Status display
Device Setup → Diag/Service → Device Status → Current Dev Status
- e) If no alarm is detected, the result of diagnostics is indicated as “Off”. If “ON” is indicated, a countermeasure for that alarm is necessary. The HART configuration tool diagnoses at each communication.

When an improper operation is performed, the alarm message is displayed.

(2) Checking with the Integral Indicator

If an alarm is detected in the self-diagnostic, an alarmcode is displayed on the digital indicator. If there is more than one alarm, the alarm codes appear in turns.

Refer to “Table 4.1 List of Alarms” to check the alarm contents and the countermeasure.

4.1.2 Status Information

(1) Device Status

Device status indicates the current operating status of the device.

Table 4.5 indicates the relation between alarm and device status.

- Procedure to call up the display
Device setup → Diag/Service → Device Status → Current Dev Status → Device Status

Device status can be masked individually. Table 4.6 indicates the mask available and the initial setting of the mask.

- Procedure to call up display
Device Setup → Diag/Service → Device Status → Device Status Mask → Status group (0 to 5, 14, 15) Mask

(2) Extended Device Status

Extended device status contains commonly used device information.

Table 4.5 indicates the relation between alarm and Extended device status.

- Procedure to call up the display
Device setup → Diag/Service → Device Status → Current Dev Status → Ext Dev Sts

(3) Device Specific Status

Device specific status indicates the current alarm status.

Table 4.5 indicates the relation between alarm and device status.

- Procedure to call up the display
Device setup → Diag/Service → Device Status → Condensed Status Map → Status group (0 to 5, 14, 15) Map

(4) Data quality and Limit status

The transmitter can handle PV, SV, TV, QV, and etc. Each variable contains data quality and limit status for providing useful status about the data value.

The data quality is normally “Good”. However, in the case of a sensor failure or out of measurement range, it turns to “Bad” or “Poor Accuracy”. The limit status indicates whether the data value is limited. (i.e., not responding to the process).

When the limit status is “Constant”, the value will not be changed.

- Procedure to call up the display
 Device setup → Process variables → Dynamic Variable → PV
 → PDQ: PV data quality
 → LS: PV limit status
 Device setup → Process variables → Device Variables → Sensor1
 → Sns1 PDQ: Sensor1 data quality
 → Sns1 LS: Sensor1 limit status
 Above procedure is the same about other variables.

Table 4.1 List of Alarms

Indicator	HART display	Cause	Output operation during alarm	Action
AL.00	CPU Fail	Main CPU failed.	According to the Burnout in Hardware failure output Communication disabled	Replace the amplifier.
AL.01	Sensor NV Fail	Sensor non-volatile memory verifies alarm.	According to the Burnout in Hardware failure output Communication enabled	
AL.02	Temp NV Fail	Non-volatile memory of TEMP ASSY verifies alarm.		
AL.03	AD Conv Fail	Input circuit hardware failed.		
AL.04	Main Rvrs Calc Fail	MAIN ASSY memory failed.		
AL.05	Temp Rvrs Calc Fail	TEMP ASSY memory failed.		
AL.06	Temp Voltage Fail	TEMP ASSY voltage failed.		
AL.07	Comm NV Fail	Communication non-volatile memory verifies alarm.		
AL.08	Temp NV Warning	Non-volatile memory of the TEMP ASSY verifies alarm.	Continue to operate and output	
AL.09	Int Comm Fail	Internal communication failed.	According to the Sensor Burnout output Communication enabled	
AL.10	Sensor1 Failure	Sensor 1 failed or disconnected from terminal block.	Refer Table 4.2.	<ul style="list-style-type: none"> • Check sensor for damage. • Check terminal connection.
AL.11	Sensor2 Failure	Sensor 2 failed or disconnected from terminal block.		
AL.12*1	Sensor1 Short	Sensor 1 short-circuited.		
AL.13*1	Sensor2 Short	Sensor 2 short-circuited.		
AL.14*1	Sensor1 Corrosion	Sensor 1 corroded.	Continue to operate and output	Check sensor, terminal, and cable.
AL.15*1	Sensor2 Corrosion	Sensor 2 corroded.		
AL.20	Sensor1 Signal Error	Sensor 1 input is out of measurable range.		
AL.21	Sensor2 Signal Error	Sensor 2 input is out of measurable range.	Refer Table 4.2	<ul style="list-style-type: none"> • Check sensor connection. • Check sensor type selected.
AL.22	Terminal Sensor Fail	Terminal block temperature is abnormal. Or terminal block temperature sensor failed.		
AL.23	Backup Sensor1 Fail	During sensor backup operation, Sensor1 fails, it has output Sensor2.	Operating to the backup side. When the backup side also fails, output is according to burnout setting.	Check sensor1 for damage.
AL.24	Backup Sensor2 Fail	During sensor backup operation, Sensor2 fails.	Continue to operate and output	Check sensor2 for damage.

Indicator	HART display	Cause	Output operation during alarm	Action	
AL.25	Sensor Drift	Sensor drift	Continue to operate and output	Check sensor for damage.	
AL.26*1	Sensor1 Temp Cycle	Temperature cycling times of Sensor1 exceeds the threshold		Reset temp cycle of sensor1.	
AL.27*1	Sensor2 Temp Cycle	Temperature cycling times of Sensor2 exceeds the threshold.		Reset temp cycle of sensor2.	
AL.30	Output Too Low	PV value is below the range limit setting.	Lower limit 3.68mA (-2%)	Check the LRV setting and adjust.	
AL.31	Output Too High	PV value is above the range limit setting.	Upper limit 20.8mA (105%)	Check the URV setting and adjust.	
AL.40	Sensor1 Temp Low	Measured temperature of sensor 1 is to low.	Continue to operate and output	Check sensor type selected.	
AL.41	Sensor1 Temp High	Measured temperature of sensor 1 is to high.			
AL.42	Sensor2 Temp Low	Measured temperature of sensor 2 is to low.			
AL.43	Sensor2 Temp High	Measured temperature of sensor 2 is to high.			
AL.44	Amb Temp Low	Ambient temperature is below-40 degree C.			Use a heater to raise the ambient temperature, or reset to a higher level.
AL.45	Amb Temp High	Ambient temperature is above 85 degree C.			Take enough distance from the source of heat, or reset to a lower level.
AL.50	LRV Too Low	LRV setting is below the sensor operating temperature range.			Check the LRV setting.
AL.51	LRV Too High	LRV setting is above the sensor operating temperature range.			
AL.52	URV Too Low	Setting the URV is below the sensor operating temperature range.			Check the URV setting.
AL.53	URV Too High	Setting the URV is above the sensor operating temperature range.			
AL.54	Span Too Small	Span is below the recommended minimum span.	Check the LRV and URV setting.		
AL.60	Illegal PV Cfg	There is a setting alarm in the sensor that is mapped to the PV	Hold the output of the previous alarm When it occurs at startup, hold at 4mA	Check the PV mapping.	
AL.61	Illegal Sensor1 Cfg	There is a false set to sensor1.	Continue to operate and output	Check the sensor1 setting.	
AL.62	Illegal Sensor2 Cfg	There is a false set to sensor2.		Check the sensor2 setting.	
AL.70	Output Manual Mode	Under loop test mode	Setting value of loop test	Check loop test mode.	

*1: Applicable only for YTA710.

Table 4.2 Output Operation

Current output mapping	Sensor1 Failure	Sensor2 Failure	Sensor1 Short*3	Sensor2 Short *3	Terminal Sensor Fail
SENS.1	Sensor Burnout	*1	Sensor Burnout	*1	*1
S.1-TER	Sensor Burnout	*1	Sensor Burnout	*1	Sensor Burnout
TERM	*1	*1	*1	*1	Sensor Burnout
SENS.2	*1	Sensor Burnout	*1	Sensor Burnout	*1
S.2-TER	*1	Sensor Burnout	*1	Sensor Burnout	Sensor Burnout
S.1-S.2	Sensor Burnout	Sensor Burnout	Sensor Burnout	Sensor Burnout	*1
S.2-S.1	Sensor Burnout	Sensor Burnout	Sensor Burnout	Sensor Burnout	*1
AVG	Sensor Burnout	Sensor Burnout	Sensor Burnout	Sensor Burnout	*1
BACKUP	*2	*2	*2	*2	*1

*1: Continue to operate and output.
 *2: When both sensor1 and sensor2 occur error, output is burnout.
 *3: Applicable only for YTA710.

4.2 Logging Functions

The YTA series have the capability to store the data useful for diagnosis of the problems.

(1) Alarm log

Up to four alarm histories are stored in the transmitter memory, and can be seen using the following procedures.

Call up the display: Device setup → Diag/Service → Status Log

(2) Max/Min log

Minimum value and Maximum value of the process variables are stored in the transmitter memory and can be checked.

- a) Procedure to call up the display
 Device setup → Diag/Service → Sensor Max/Min Log
- b) To clear the logged data for Process variables except Term variables, select reset Sns Max/Min.



NOTE

These values may become big by disconnection of the sensor, etc. Please reset in this case.

(3) Operation Time

Transmitter's operation time from the first power-on is counted. Call up the "Operation Time" display to check the time.

Device setup → Detailed setup → Device information → Date & Time → Operation Time



NOTE

Operation Time is saved every 15 minutes.

4.3 Diagnostics Function

The YTA has the following diagnostic functions.

(1) Hardware Failure

This function detects Failures of CPU, AD converter, memory, etc.

(2) Sensor Failure

This function detects any disconnection of sensors. When the current is applied and the resistance of a sensor is above the threshold, the function outputs a disconnection alarm.

Parameter setting: Not necessary

Alarm output: When the resistance is above the threshold, the function outputs the alarm of Sensor1 Failure (AL.10) or Sensor2 Failure (AL.11).

(3) Terminal block Failure

This function detects any disconnection at CJC. When it detects that the resistance of CJC is above the threshold, the function outputs an alarm.

Parameter setting: Not necessary

Alarm output: When the resistance is above the threshold, the function outputs the alarm of Terminal Sensor Fail (AL.22).

(4) TC Short (only for YTA710)

This function detects any short circuit at TC sensors. When the current is applied and the resistance of a sensor is (S1 RP23, S2 RP43 in Sensor Diagnostics Information) below the threshold, the function outputs the Short alarm.

Parameter setting: Set the thresholds at "S1 TC Short Thrshld" and "S2 TC Short Thrshld" (for the 2-input specification).

Alarm output: When the resistance is below the threshold, the function outputs the alarm of Sensor1 short (AL.12) or Sensor2 short (AL.13).

- Procedure to call up the display
Device setup → Diag/Service → Diagnostics → Sensor Diag → Sensor Diag Setting → S1(2) TC Short Thrshld
Set thresholds.



NOTE

Release the Device Status mask in order to output the Sensor1 (2) Short alarm. (Initial value is set in the mask)

(5) RTD Short (only for 3-wire and 4-wire, only for YTA710)

This function detects any short circuit at the sensor during the RTD or Ohm measurement. When the resistance of the Sensor (S1 RC1 to S1 RC4, S2 RC3, S2 RC4 in Sensor Diagnostics Information) is below the threshold, the function outputs a short circuit alarm.

Parameter setting: Not necessary

Alarm output: When the resistance is below the threshold, the function outputs the alarm of Sensor1 short or Sensor2 short.



NOTE

- Release the Device Status mask in order to output the Sensor1 (2) Short alarm. (Initial value is set in the mask)
- In case of 3 wire RTD or ohm connection, if actual connection and connection setting is imbalance, unforeseen alarm may be generated.

(6) RTD Corrosion (only for 3-wire and 4-wire, only for YTA710)

This function detects any corrosion at the terminals and along the measurement cables. When the resistance of the terminals and cables (S1 RC1 TO S1 RC4, S2 RC3, S2 RC4 in sensor diagnostics information.) is above the threshold, the function outputs a corrosion alarm (AL.14 and AL.15).

Parameter setting:

Device Setup → Diag/Service → Diagnostics → Sensor Diag → Sensor1(2) Diag setting → S1(S2) RTD Corr Thrshld,



NOTE

Release the Device Status mask in order to output the Sensor1 (2) Corrosion alarm. (Initial value is set in the mask)

(7) Sensor Drift

When the difference between Sensor1 and Sensor2 temperatures becomes larger than the threshold, this function outputs an alarm. This indicates that there is some problem at either Sensor1 or Sensor2. The function can be enabled when Sensor type is set to TC and RTD.

Parameter setting: Set a threshold for the temperature difference between Sensor1 and Sensor2 at Sns Drift thrshld. When the threshold is 0.0, the function is not enabled.

Alarm output: When the temperature difference is larger than the threshold, the function outputs the alarm of Sensor Drift.

- Procedure to call up the display
Device setup → Diag/Service → Diagnostics → Sensor Diag → Sensor Diag Setting → Sns Drift Thrshld
Set thresholds.



NOTE

Release the Device Status mask in order to output the Sensor Drift alarm. (Initial value is set in the mask)

(8) Temperature Cycle Diagnostics (only for YTA710)

This function displays the number of temperature fluctuations that may cause failure of the sensor. The function is enabled only when Sensor type is set to TC or RTD, and indicates how many times the temperature alternately hits (or crosses) the upper and lower limits. When the number of times exceeds the threshold, an alarm will be issued. When the threshold is set to 0 the function is not enabled.

- Procedure to call up the display
Device setup → Diag/Service → Diagnostics → Temp Cycle Diag

Temp Cycle Val Unit: The unit of temperature

Temp Cycle Upr Val: Upper limit
(initial setting: 2000°C)

Temp Cycle Lwr Val: Lower limit
(initial setting: -273°C)

Temp Cy Alm thrsld: Threshold for outputting the alarm

rst Temp Cycle Cnt: Reset the number of cycles

Output:

Number of cycles (Temp Cycle S1 Cnt, Temp Cycle S2 Cnt)

Alarm output (S1 Over Temp Cycle, S2 Over Temp Cycle)



NOTE

Release the Device Status mask in order to output the Sensor 1(2) Temp Cycle alarm. (Initial value is set in the mask)

(9) Sensor Diagnostics Information

Information obtained by the sensor diagnostics are displayed in the parameters below. You can take advantage of the preventive maintenance of the sensor by obtaining this information periodically.

Table 4.3 Sensor1 diagnostics information

Parameter	Sensor type		
	TC	RTD 3-wire	RTD 4-wire
S1 RP23 (Resistance between terminal 2 and 3)	✓	0.0	0.0
S1 RC1 (Resistance between sensor cable and terminal connection to terminal1)	0.0	0.0	✓
S1 RC2 (Resistance between sensor cable and terminal connection to terminal2)	0.0	✓	✓
S1 RC3 (Resistance between sensor cable and terminal connection to terminal3)	0.0	✓	✓
S1 RC4 (Resistance between sensor cable and terminal connection to terminal4)	0.0	0.0	✓

✓: Display sensor diagnostics information (resistance).

Table 4.4 Sensor2 diagnostics information

Parameter	Sensor type	
	TC	RTD 3-wire
S2 RP43 (Resistance between terminal 2 and 3)	✓	0.0
S2 RC4 (Resistance between sensor cable and terminal connection to terminal4)	0.0	✓
S2 RC3 (Resistance between sensor cable and terminal connection to terminal3)	0.0	✓

✓: Display sensor diagnostics information (resistance).

Table 4.5 Relation between Alarm and (Extended) Device Status

		bit	PV Out of Limit	Non-PV Out of Limit	AO Saturated	AO Fixed	More Status Available	Device Malfuction	Device Variable Alert	NV memory failure	RAM error	Env Cnd out of range	Electronic failure
		bit	0	1	2	3	4	7	1	1	2	5	6
Name	bit	Description	Field Device Status					Extended Device Status	Standardized Status0				
Extended Device Status	0	Maintenance Required					x						
	1	Device Variable Alert					x						
	3	Failure					x						
	4	Out of Specification					x						
	5	Function Check					x						
Standardized Status0	0	Simulation Active				x	x						
	1	NV memory failure					x	x					
	2	RAM error					x	x					
	3	Watchdog Reset					x						
	5	Env Cnd Out of Range					x						
	6	Electronic failure					x	x					
	7	Device Config Locked					x						
Standardized StatusSensor1	0	Status Sim Active					x						
	2	Event Overflow					x						
Device Specific Status 0	0	CPU Fail					x	x					x
	1	Sensor NV Fail					x	x		x			
	2	Temp NV Fail					x	x		x			
	3	AD Converter Fail					x	x					x
	4	Main Rvrs Calculation Fail					x	x			x		
	5	Temp Rvrs Calculation Fail					x	x			x		
	6	Temp Voltage Fail					x	x					x
	7	Comm NV Fail					x	x		x			
Device Specific Status 1	0	Temp NV Warning					x						
	1	Int Comm Fail					x	x					x
Device Specific Status 2	0	Sensor1 Failure	x	x			x	x					
	1	Sensor2 Failure	x	x			x	x					
	2	Sensor1 Short*1	x	x			x	x					
	3	Sensor2 Short*1	x	x			x	x					
	4	Sensor1 Corrosion*1					x						
	5	Sensor2 Corrosion*1					x						
	6	Sensor1 Signal Error					x		x				
	7	Sensor2 Signal Error					x		x				
Device Specific Status 3	0	Terminal Sensor Fail					x	x					
	1	Backup Sensor1 Fail					x						
	2	Backup Sensor2 Fail					x						
	3	Sensor Drift					x						
	4	Sensor1 Temp Cycle*1					x						
	5	Sensor2 Temp Cycle*1					x						
Device Specific Status 4	0	Output Too Low			x		x						
	1	Output Too High			x		x						
	2	Sensor1 Temp Low	x	x			x		x				
	3	Sensor1 Temp High	x	x			x		x				
	4	Sensor2 Temp Low	x	x			x		x				
	5	Sensor2 Temp High	x	x			x		x				
	6	Amb Temp Low					x		x			x	
	7	Amb Temp High					x		x			x	

Name	bit	Description	Field Device Status							Extended Device Status	Standardized Status0		
			PV Out of Limit	Non-PV Out of Limit	AO Saturated	AO Fixed	More Status Available	Device Malfunction	Device Variable Alert	NV memory failure	RAM error	Env Cnd out of range	Electronic failure
Device Specific Status 5	1	LRV Too Low					x						
	2	LRV Too High					x						
	3	URV Too Low					x						
	4	URV Too High					x						
	5	Span Too Small					x						
Device Specific Status 14	0	Illegal PV Cfg					x						
	1	Illegal Sensor1 Cfg					x						
	2	Illegal Sensor2 Cfg					x						
Device Specific Status 15	0	Output Manual Mode					x						

*1: Applicable only for YTA710.

Table 4.6 NE-107 Condensed Status and Status Mask

Name	bit	Description	NAMUR-107	Mask Available	Initial Setting
Field Device Status	0	PV Out of Limits	S		No mask
	1	Non-PV Out of Limits	S		No mask
	2	AO Saturated	S		No mask
	3	AO Fixed			No mask
	4	More Status Available			No mask
	5	Cold Start			No mask
	6	Config Changed			No mask
	7	Device Malfunction			No mask
Extended Device Status	0	Maintenance Required			No mask
	1	Device Variable Alert	S		No mask
	3	Failure			No mask
	4	Out of Specification			No mask
	5	Function Check			No mask
Standardized Status0	0	Simulation Active	C		No mask
	1	NV memory failure	F		No mask
	2	RAM error	F		No mask
	3	Watchdog Reset	F		No mask
	5	Env Cnd Out of Range			No mask
	6	Electronic failure	F		No mask
	7	Device Config Locked			No mask
Standardized StatuSensor1	0	Status Sim Active			No mask
	2	Event Overflow			No mask
Device Specific Status 0	0	CPU Fail	F		No mask
	1	Sensor NV Fail	F		No mask
	2	Temp NV Fail	F		No mask
	3	AD Converter Fail	F		No mask
	4	Main Rvrs Calc Fail	F		No mask
	5	Temp Rvrs Calc Fail	F		No mask
	6	Temp Voltage Fail	F		No mask
	7	Comm NV Fail	F		No mask

Name	bit	Description	NAMUR-107	Mask Available	Initial Setting
Device Specific Status 1	0	Temp NV Warning	M	✓	No mask
	1	Int Comm Fail	F		No mask
Device Specific Status 2	0	Sensor1 Failure	F	✓	No mask
	1	Sensor2 Failure	F	✓	No mask
	2	Sensor1 Short*1	F	✓	Mask
	3	Sensor2 Short*1	F	✓	Mask
	4	Sensor1 Corrosion*1	M	✓	Mask
	5	Sensor2 Corrosion*1	M	✓	Mask
	6	Sensor1 Signal Error	S	✓	No mask
	7	Sensor2 Signal Error	S	✓	No mask
Device Specific Status 3	0	Terminal Sensor Fail	F	✓	No mask
	1	Backup Sensor1 Fail	M	✓	No mask
	2	Backup Sensor2 Fail	M	✓	No mask
	3	Sensor Drift	M	✓	Mask
	4	Sensor1 Temp Cycle*1	M	✓	Mask
	5	Sensor2 Temp Cycle*1	M	✓	Mask
Device Specific Status 4	0	Output Too Low	S	✓	No mask
	1	Output Too High	S	✓	No mask
	2	Sensor1 Temp Low	S	✓	No mask
	3	Sensor1 Temp High	S	✓	No mask
	4	Sensor2 Temp Low	S	✓	No mask
	5	Sensor2 Temp High	S	✓	No mask
	6	Amb Temp Low	S	✓	No mask
	7	Amb Temp High	S	✓	No mask
Device Specific Status 5	1	LRV Too Low	C	✓	No mask
	2	LRV Too High	C	✓	No mask
	3	URV Too Low	C	✓	No mask
	4	URV Too High	C	✓	No mask
	5	Span Too Small	C	✓	No mask
Device Specific Status 14	0	Illegal PV Cfg	C	✓	No mask
	1	Illegal Sensor1 Cfg	C	✓	No mask
	2	Illegal Sensor2 Cfg	C	✓	No mask
Device Specific Status 15	0	Output Manual Mode	C	✓	No mask

*1: Applicable only for YTA710.

5. Parameters Lists

RW: read/write
R: read only, M: Method

Item		Parameter	Description	Write	Initial Setting
Memory		Tag	Up to 8 characters	RW	
		Long Tag	Up to 32 characters	RW	
		Descriptor	Up to 16 characters	RW	
		Message	Up to 32 characters	RW	
		Date		RW	
Process variable	Engineering Unit	PV Unit (SV,TV, QV)	Process variable unit	RW	°C
	Range	LRV/URV	Specify the calibration range.	RW	LRV: 0 URV: 100
		Apply values	Value for 4 and 20 mA signal is set with actual input applied	M	—
	Damping time constant	AO Damping	Specify the response time of process variable within 0 to 100 seconds.	RW	0 s
	Damping holding point	AO Damp Point	Specify the % of the output range. When the amount of variation is larger than the set value, it does not perform the dumping process.	RW	0%
	Variable mapping	PV is (SV, TV, QV)	Sensor1, Terminal, Sensor1-Terminal (for single input) Sensor2, Sensor1-Sensor2, Sensor2-Sensor1, Average, Sensor2-Terminal: (for dual input) Sensor backup	RW	PV: Sensor1 SV: Terminal TV: Terminal QV: Terminal
Sensor1 Configuration	Sensor1 Type and wire	set Sns1 Probe	Specify sensor type and number of wires.	M	
	Sensor1 type	Sns1 Probe Type	Sensor1 type.	R	Pt100
	Sensor1 wire	Sns1 Wire	Number of Sensor1 wires	R	3 Wire
	Sensor1 unit	Sns1 Unit	°C, K, °F, °R, mV or ohm	RW	°C
	Sensor1 damping	Sns1 Damp	Specify the response time of sensor1 within 0 to 100 seconds.	RW	2s
	Sensor1 matching	set Sns1 Matching		This function is available only when optional specification /CM1 is specified. Select enable or disable.	M
Sns1 CVD (R0, A, B, C, Al pha, Delta, Beta)			Sensor1 matching co-efficient.	R	

Item		Parameter	Description	Write	Initial Setting
Sensor2 Configuration	Sensor2 Type and wire	set Sns2 Probe	Specify sensor type and number of wires.	M	
	Sensor2 type	Sns2 Probe Type	Sensor2 type	R	Pt100
	Sensor2 wire	Sns2 Wire	Number of Sensor2 wires	R	3 Wire
	Sensor2 unit	Sns2 Unit	°C, K, °F, °R, mV or ohm	RW	°C
	Sensor2 damping	Sns2 Damp	Specify the response time of sensor1 input within 0 to 100 seconds.	RW	2s
	Sensor2 matching	set Sns2 Matching	This function is available only when optional specification /CM1 is specified. Select "Enable" or "Disable".	M	
		Sns2 CVD (R0, A, B, C, Al pha, Delta, Beta)	Sensor2 matching co-efficient.	R	
	Sensor backup	recover Sensor	Recover Backup Operation.	M	
Sensor Backup State		Show the backup state.	R		
Terminal Temperature	Terminal temp. unit	Term Unit	Specify from °C, K, °F, or °R	RW	°C
	Terminal damping	Term Damp	Specify the response time of terminal temperature within 0 to 100 seconds.	RW	2 s
	CJC function	Set CJC Type		M	
		CJC Type	"Internal CJC" to use temperature or "Constant CJC" to use constant value.	R	Internal CJC
		Fixed CJC Temp	Specify constant value using CJC function.	R	
Fixed CJC Unit			R		
Output	Sensor burn-out output	AO Sensor BO Dir	Select Sensor Burnout direction.	RW	High
		AO Sensor BO Unit	Select mA or %	RW	
		AO Sensor BO Ustr Val	Specify value within 3.6 to 21.6 (mA) or -2.5 to 110%	RW	
	Output in CPU failure	AO Alarm Typ	Show the current setting of the output direction in hardware failure which is set using switch on a MAIN assembly	R	
	Burst mode	Burst mode	Off or ON	M	Off
		set Easy Burst	Configure Burst mode	M	
		set Detailed Burst	Configure Burst mode	M	
		Burst Command	Cmd 1:PV Cmd 2:% range/current Cmd 3:Dyn vars/current Cmd 9:Device vars w/status Cmd33:Device vars Cmd 48:Read Additional Device Status	M	
		Burst Variable Code	Device Variable for the Burst Message Max 4 slots.	M	
		Update Period	Update Period for Burst mode	M	
		Max Update Period	Max Update Period for Burst mode	M	
		Burst Msg Trigger Mode	Burst Trigger Mode Selection Code Continuous, Window, Rising, Falling, On-change	M	
		Burst Trigger Class		RW	
		Burst Trigger Units	Unit for Burst Trigger	RW	
		Burst Trigger Level		M	
	Multi-drop mode	Poll addr	0 to 63	RW	0
		Loop Current mode	Enabled: 4 to 20 mA output Disabled: 4 mA fixed	RW	Disabled

Item		Parameter	Description	Write	Initial Setting
Display	Display selection	Disp1 Variable	Select from Table 3.1.	RW	
		Disp2 Variable	Select from Table 3.1.	RW	
		% Display On/Off	Select On or Off.	RW	
		mA Display On/Off	Select On or Off.	RW	
		Bar Graph On/Off	Select On or Off.	RW	
		exec Squawk	Select On, Off or Once.	M	On
	Display resolution	Disp1 Decimal Point	Select from 0, 1, 2 or 3.	RW	
		Disp2 Decimal Point		RW	
		% Decimal Point		RW	
		mA Decimal Point		RW	
Display cycle	Display Cycle	Select High (1.2s), Mid (2.4s) or Low (3.6s).	RW	Mid	
Monitoring	Process variable	Sns1 Value*1	Process variables	R	
	Output in %	PV % rng	% output variable	R	
	Output in mA	Loop current	4 to 20 mA output variable	R	
	Device variables	Sns1 Value	Sensor 1 value	R	
		S1-T Value	Sensor1 – Terminal value	R	
		Term Value	Terminal value	R	
		Sns2 Value	Sensor2 value	R	
		S2-T Value	Sensor2 – Terminal value	R	
		S1-S2 Value	Sensor1 – Sensor2 value	R	
		S2-S1 Value	Sensor2 – Sensor1 value	R	
		AV Value	Average value	R	
SnsBck Value		Sensor backup value	R		
Maintenance	Test output	exec Loop Test		M	
	Self-diagnostics	exec Self Test		M	
		enable Dev Var Sim		M	
		en/ds Dev Sts Sim		M	
		Status Log (0 to 9)	Alarm log	R	
		Sensor Max/Min Log	Minimum value and maximum value of process variables.	R	
		Operation Time	Transmitter's operation time	R	
	Write protect	Write protect		R	
		release WP Mode		M	
		set New password		M	
Adjustment	Sensor trim	set Sensor1 (2) Trim	Adjust sensor input signal.	M	
	Analog output trim	set AO Trim	Adjust 4 to 20 mA output.	M	
Referential information	Distributor	Yokogawa		R	
	Model			R	
	Devid	Device ID		R	
	Final asmbly num	Final assembly number		RW	
	Universal rev	HART 7		R	
	Fld dev rev	Field device revision		R	
	Software rev	Software revision		R	
	Sns1(2) LSL	Lower limit for sensor1(2)		R	
Sns1(2) USL	Upper limit for sensor1(2)		R		

*1: Parameter depends on the process variables mapping.

Appendix A. Safety Instrumented Systems Installation



WARNING

The contents of this appendix are cited from exida.com safety manual on the YTA series temperature transmitters specifically observed for the safety transmitter purpose. When using the YTA for Safety Instrumented Systems (SIS) application, the instructions and procedures in this section must be strictly followed in order to preserve the transmitter for that safety level.

A.1 Scope and Purpose

This section provides an overview of the user responsibilities for installation and operation of the YTA in order to maintain the designed safety level for Safety Instrumented Systems (SIS) applications. Items that will be addressed are proof testing, repair and replacement of the transmitter, reliability data, lifetime, environmental and application limits, and parameter settings.

A.2 Using the YTA for an SIS Application

A.2.1 Safety Accuracy

The YTA has a specified safety accuracy of 2%. This means that the internal component failures are listed in the device failure rate if they will cause an error of 2% or greater.

A.2.2 Diagnostic Response Time

The diagnostic test interval of YTA is less than 60 seconds and the diagnosis response time (time to detect and notify an interval failures) is less than 2 seconds.

A.2.3 Setup

Set the ranges and units by the HART configuration tool. After configuration, make sure that the ranges and units are set correctly. The calibration of the YTA must be performed after parameters are set.

A.2.4 Required Parameter Settings

The following parameters need to be set in order to maintain the designed safety integrity. Table A.2.1 describes the setting of the hardware error burnout and hardware write protect switch. Table A.2.2 describes the parameter setting by software.

Table A.2.1 Required setting of hardware error burnout and hardware write protect switch

Item	Description
Hardware error burnout direction switch	To specify if the output should go to 21.6 mA or higher or 3.2 mA or lower upon detection of an internal failure.
Write protect switch	The write function disabled.

Table A.2.2 Parameters to be set by software

Parameter	Description
PV is	Set it to sensor 1 or sensor 2. The set sensor will be analog output.
AO Sensor BO Dir	To specify if the output should go to High (21.6 mA or higher) or Low (3.6 mA or lower) upon detection of a sensor failure.

A.2.5 Proof Testing

The objective of proof testing is to detect failures within the transmitter that are not detected by the diagnostics of the transmitter. Of main concern are undetected failures that prevent the safety instrumented function from performing its intended function. See table A.2.3 for proof testing method.

The frequency of the proof tests (or the proof test interval) is to be determined in the reliability calculations for the safety instrumented functions for which the YTA is applied. The actual proof tests must be performed more frequently or as frequently as specified in the calculation in order to maintain required safety integrity of the safety instrumented function.

The following tests need to be specifically executed when a proof test is performed. The results of the proof test need to be documented and this documentation should be part of a plant safety management system. Failures that are detected should be reported to Yokogawa.

The personnel performing the proof test of the transmitter should be trained in SIS operations including bypass procedures, YTA temperature transmitter maintenance, and company management of change procedures.

Table A.2.3 Proof Testing

Testing method	Tools required	Expected outcome	Remarks
<p>Analog Output Loop Test:</p> <ol style="list-style-type: none"> 1. Bypass the safety PLC or take other appropriate action to avoid a false trip. 2. Send a HART command to the transmitter to go to the high alarm current output and verify that the analog current reaches that value. 3. Send a HART command to the transmitter to go to the low alarm current output and verify that the analog current reaches that value. 4. Use the HART communicator to view detailed device status to ensure no alarms or warnings are present in the transmitter. 5. Perform reasonability check on the sensor value(s) versus an independent estimate (i.e. from direct monitoring of BPCS value) to show current reading is good. 6. Restore the loop to full operation. 7. Remove the bypass from the safety PLC or otherwise restore normal operation. 	<ul style="list-style-type: none"> • Handheld terminal 	<p>Proof Test Coverage *</p> <p>for TC input: 61%</p> <p>for RTD input: 69%</p>	<p>The output needs to be monitored to assure that the transmitter communicates the correct signal.</p>
<p>Analog Output Loop Test and Temperature Spot Check:</p> <ol style="list-style-type: none"> 1. Bypass the safety PLC or take other appropriate action to avoid a false trip. 2. Perform Analog Output Loop Test. 3. Verify the measurement for two temperature points. 4. Perform reasonability check of the housing temperature. 5. Restore the loop to full operation. 6. Remove the bypass from the safety PLC or otherwise restore normal operation. 	<ul style="list-style-type: none"> • Handheld terminal 	<p>Proof Test Coverage *</p> <p>for TC input: 86%</p> <p>for RTD input: 86%</p>	<p>The output needs to be monitored to assure that the transmitter communicates the correct signal.</p>

*: For details of the proof test coverage, refer to the FMEDA No. YEC 15-10-041 R001 or No.YEC 15-10-041 R002.
 Website address: <http://www.yokogawa.com/fld/>

A.2.6 Repair and Replacement

If repair is to be performed with the process online, the YTA will need to be bypassed during the repair. The user should setup appropriate bypass procedures.

In the unlikely event that the YTA has a failure, the failures that are detected should be reported to Yokogawa.

When replacing the YTA, the procedure in the installation manual should be followed.

The personnel performing the repair or replacement of the YTA should have a sufficient skill level.

A.2.7 Startup Time

The YTA generates a valid signal within 7 seconds of power-on startup.

A.2.8 Firmware Update

In case firmware updates are required, they will be performed at factory. The replacement responsibilities are then in place. The user will not be required to perform any firmware updates.

A.2.9 Reliability Data

A detailed Failure Mode, Effects, and Diagnostics Analysis (FMEDA) report is available from Yokogawa with all failure rates and failure modes.

The YTA is certified up to SIL2 for use in a simplex (1oo1) configuration, depending on the PFDavg respectively PFH calculation of the entire Safety Instrumented Function.

The development process of the YTA is certified up to SIL3, allowing redundant use of the transmitter up to this Safety Integrity Level, depending the PFDavg respectively PFH calculation of the entire Safety Instrumented Function.

When using the transmitter in a redundant configuration, the use of a common cause factor (β -factor) of 5% is suggested. If the owner-operator of the plant would institute common cause failure training and more detailed maintenance procedures for avoiding common cause failure, a beta factor of 2% would be applicable.

*: For details of the PFDavg, please refer to the FMEDA No. YEC 15-10-041 R001 or No. YEC 15-10-041 R002. Website address: <http://www.yokogawa.com/fld/>

A.2.10 Lifetime Limits

The expected lifetime of the YTA is 50 years. The reliability data listed in the FMEDA report is only valid for this period. The failure rates of the YTA may increase sometime after this period. Reliability calculations based on the data listed in the FMEDA report for YTA lifetimes beyond 50 years may yield results that are too optimistic, i.e. the calculated Safety Integrity Level will not be achieved.

A.2.11 Environmental Limits

The environmental limits of the YTA are specified in the user's manual IM 01C50G01-01EN.

A.2.12 Application Limits

The application limits of the YTA are specified in the user's manual IM 01C50G01-01EN. If the transmitter is used outside of the application limits, the reliability data listed in A.2.9 becomes invalid.

A.3 Terms and Definitions

FMEDA	Failure Mode Effect and Diagnostic Analysis
SIF	Safety Instrumented Function
SIL	Safety Integrity Level
SIS	Safety Instrumented System - Implementation of one or more Safety Instrumented Functions. A SIS is composed of any combination of sensor(s), logic solver(s), and final element(s).
SLC Safety	Safety Lifecycle Freedom from unacceptable risk of harm
Functional Safety	The ability of a system to carry out the actions necessary to achieve or to maintain a defined safe state for the equipment / machinery / plant / apparatus under control of the system
Basic Safety	The equipment must be designed and manufactured such that it protects against risk of damage to persons by electrical shock and other hazards and against resulting fire and explosion. The protection must be effective under all conditions of the nominal operation and under single fault condition

Verification The demonstration for each phase of the life-cycle that the (output) deliverables of the phase meet the objectives and requirements specified by the inputs to the phase. The verification is usually executed by analysis and / or testing

Validation The demonstration that the safety-related system(s) or the combination of safety-related system(s) and external risk reduction facilities meet, in all respects, the Safety Requirements Specification. The validation is usually executed by testing.

Safety Assessment
The investigation to arrive at a judgment - based on evidence - of the safety achieved by safety-related systems

Further definitions of terms used for safety techniques and measures and the description of safety related systems are given in IEC 61508-4.

Revision Information

- Title : YTA610 and YTA710
Temperature Transmitters (HART Protocol)
- Manual No. : IM 01C50T01-02EN

Edition	Date	Page	Revised Item
1st	June 2016	—	New Publication
2nd	Oct. 2016	— — 3-3, 3-4 3-11 4-2, 4-3 4-4 4-5, 4-6 4-7, 4-8 4-9 A-1	Add YTA610. Incorporate Manual Change 16-045 and 16-039 Add note *2 Add one case to 2-input model Add note *1 Add note *1 Add note *3 Add note "only for YTA710" Add note *1 Add note *1 Add Appendix A
3rd	Mar. 2017	3-11 A-2 A-3	Delete *1 Change of FMEDA No. for YTA710 Add FMEDA No. for YTA610