

## S300 PR

*Heavy duty sensor for outdoor applications and harsh environments*

- Industrial plastic housing with IP67 mechanical protection
- Defogging system function
- Double independent timing functions with double time scale from 0-2s or 0-10s, One-Delay, Off Delay, ONE SHOT



### APPLICATIONS

- Packaging end of line, palletizers
- Outdoor or indoor gates control
- Automotive plants
- Automated warehousing

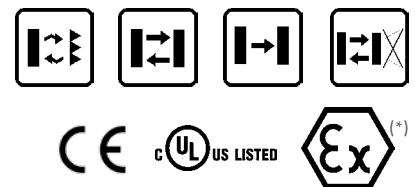

(\*)DC models:  
ATEX II 3DG

S300 PA		
Through beam		0...60 m
Polarized retroreflective		0,1...22 m
Diffuse proximity		0,05...5 m
Background suppression		0,4...2,5 m
Power supply	Vdc	10...30 V
	Vac	
	Vac/dc	24...240 Vac / 24...60 Vdc
Output	PNP	
	NPN	
	NPN/PNP	▪
	relay	▪
	other	
Connection	cable	
	connector	▪
	pig-tail	
Approximate dimensions (mm)		25x100x70
Housing material		PBT
Mechanical protection		IP67

### TECHNICAL DATA

Power supply	10 ... 30 Vdc (mod. S300...2/5)
Ripple	24...240 Vac/24...60 Vdc (mod. S300...1) 10% max.
Consumption (output current excluded)	30 mA max. (mod. S300...2/5-B/C) 35 mA max. (mod. S300...2/5-M) 25 mA max. (mod. S300...2/5-F) 20 mA max. (mod. S300...2/5-G) 3 VA max. (mod. S300...1)
Light emission	red LED 660 nm (mod. S300...B) IR LED 880 nm (mod. S300...C/G/M)
Setting	sensitivity trimmer, DARK/LIGHT trimmer (mod. S300...F/C/B) 15 turns adjustment screw/DARK/LIGHT trimmer (mod. S300...M) emission power regulation trimmer (mod. S300...G) versions with timing functions: time base selection and one shot trimmer/ON DELAY trimmer/OFF DELAY trimmer (mod. S300...x06) yellow OUTPUT LED (excl. mod. S300...G)
Indicators	green STABILITY LED, POWER LED (mod. S300...G)
Output	PNP or NPN open collector (mod. S300...2/5); Electromechanical SPDT 250 Vac/30 Vdc (mod. S300...1)
Output current	100 mA (mod. S300...2/5)
Saturation voltage	3 A max. (mod. S300...1) 2,4 V max.
Response time	1 ms (mod. S300...2/5-B/C/F/G) 2 ms (mod. S300...2/5-M) 20 ms (mod. S300...1)
Switching frequency	500 Hz (mod. S300...2/5-B/C/F/G) 250 Hz (mod. S300...2/5-M) 25 Hz (mod. S300...1)
Connection	terminal block, M12 4-pole connector (only DC mod.)
Dielectric strength	500 Vac, 1 min between electronics and housing
Insulating resistance	>20 MΩ, 500 Vdc between electronics and housing
Electrical protection	class 2 (mod. S300...2/5)
Mechanical protection	IP67 (IEC/EN60529)/cable gland EN50262
Ambient light rejection	according to EN 60947-5-2
Vibrations	0,5 mm amplitude, 10 ... 55 Hz frequency, for every axis (EN60068-2-6)
Shock resistance	11 ms (30 G) 6 shock for every axis (EN60068-2-27)
Housing material	PBT 30% glass fiber-reinforced
Lens material	frontal window and lens in PC
Operating temperature	-40 ... 55 °C
Storage temperature	-40 ... 70 °C
Weight	140 g (mod. S300...2/5), 150 g (mod. S300...1)

### DIMENSIONS

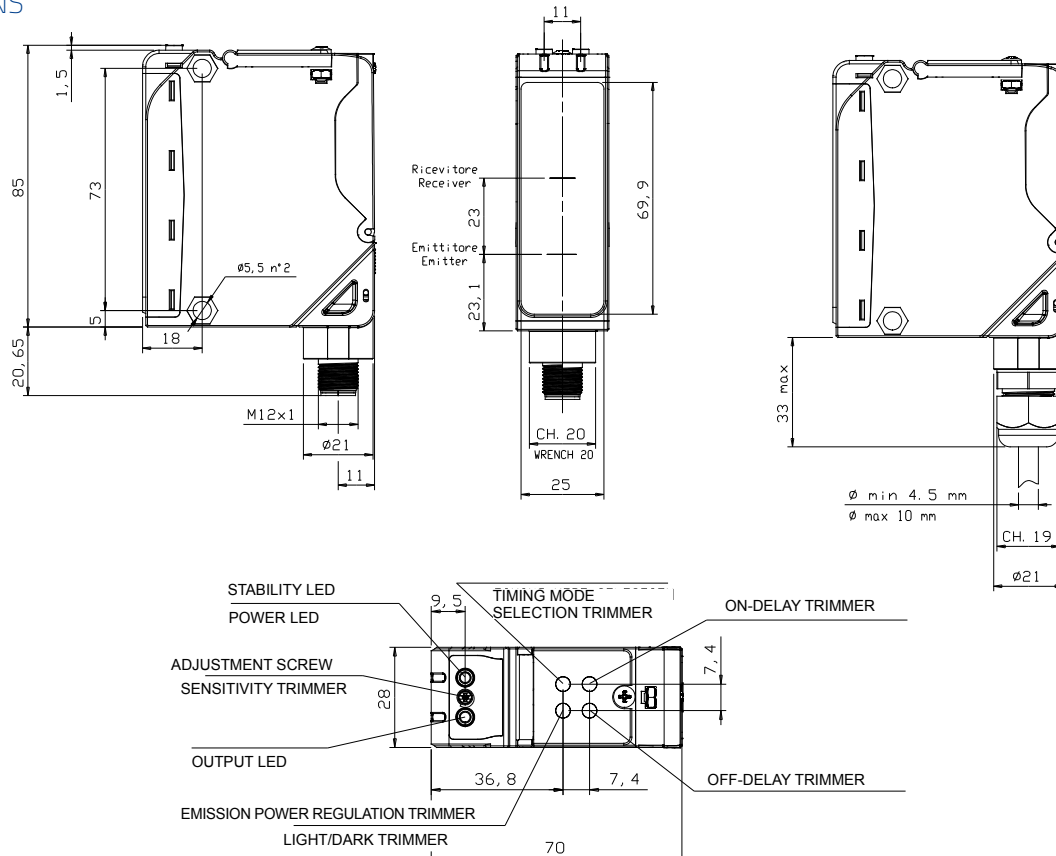

# MAXI SENSORS

## INDICATORS AND SETTINGS

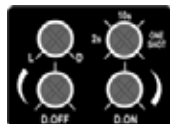
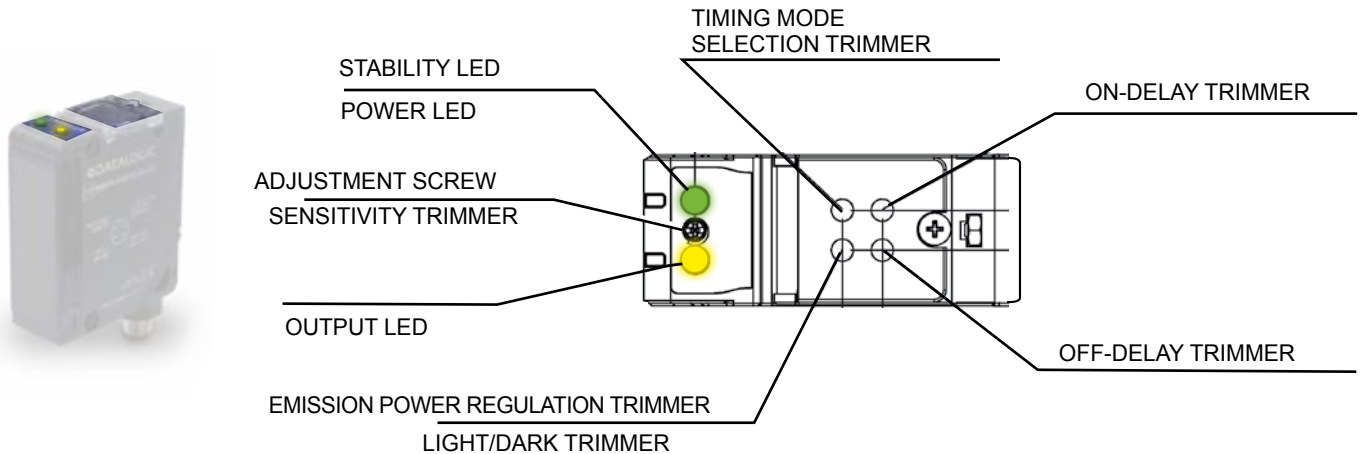

Vers. with timing functions



Vers. without timing functions

## CONNECTIONS

### AC MODELS

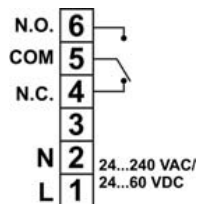

### DC MODELS

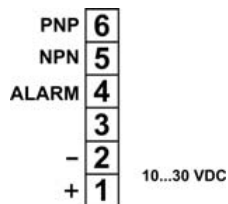

### M12 CONNECTOR (only DC models)

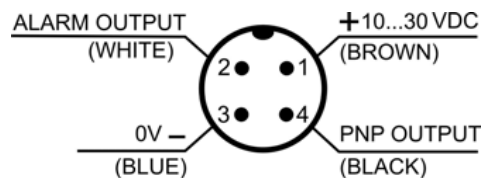

Through beam emitter

### AC MODELS

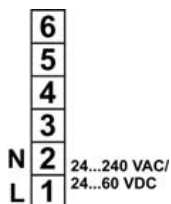

### DC MODELS

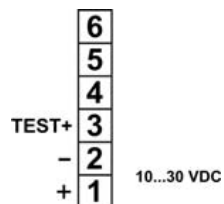

### M12 CONNECTOR (only DC models)

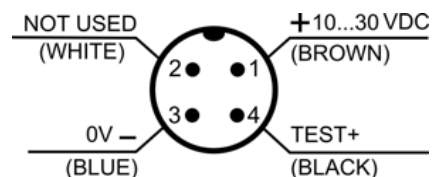

## DETECTION DIAGRAMS

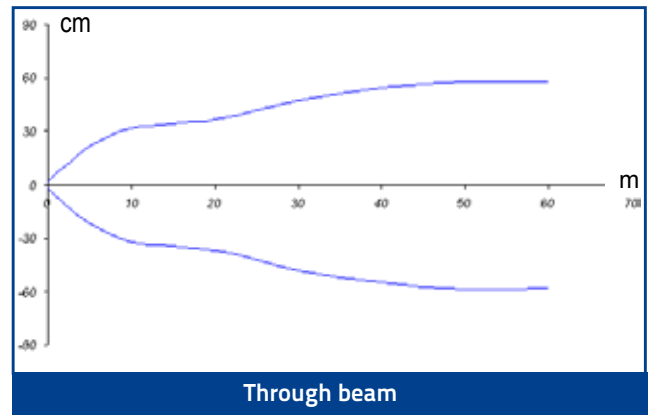
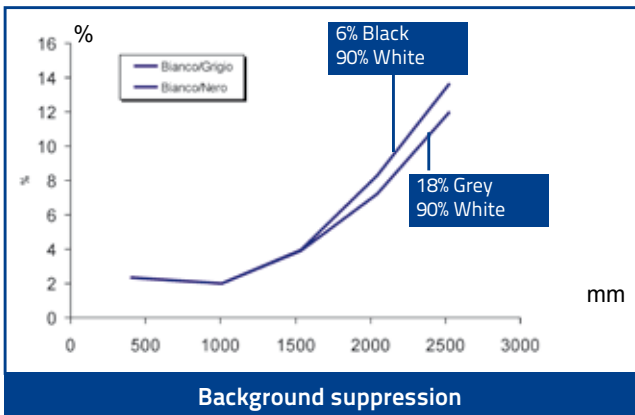
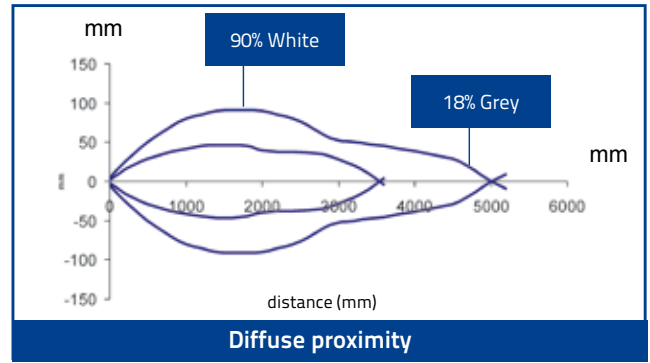
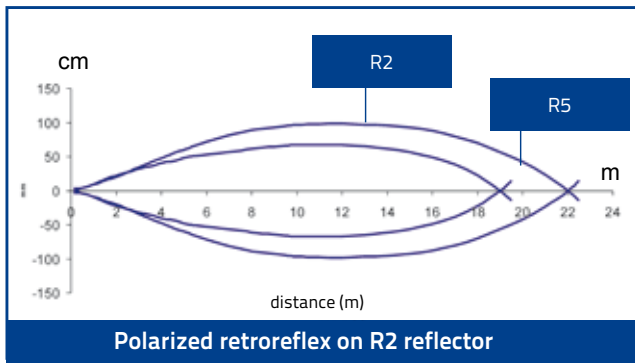

## MODEL SELECTION AND ORDER INFORMATION

OPTIC FUNCTION	OUTPUT	CONNECTION	SETTING	MODEL	ORDER No.
Polarized retroreflective	NPN/PNP	Vdc - Terminal block	Sensitivity and D/L trimmers	S300-PR-2-B01-OC	951451000
			Timing, sensitivity and D/L trimmers	S300-PR-2-B06-OC	951451010
		Vdc - M12 Connector	Sensitivity and D/L trimmers	S300-PR-5-B01-OC	951451020
			Timing, sensitivity and D/L trimmers	S300-PR-5-B06-OC	951451030
	Relay	Vac - Terminal block	Sensitivity and D/L trimmers	S300-PR-1-B01-RX	951451040
			Timing, sensitivity and D/L trimmers	S300-PR-1-B06-RX	951451050
Diffused proximity	NPN/PNP	Vdc - Terminal block	Sensitivity and D/L trimmers; defogging function	S300-PR-1-B06-RX-M	951451060
			Sensitivity and D/L trimmers	S300-PR-2-C01-OC	951451070
		Vdc - M12 Connector	Timing, sensitivity and D/L trimmers	S300-PR-2-C06-OC	951451080
			Sensitivity and D/L trimmers	S300-PR-5-C01-OC	951451090
	Relay	Vac - Terminal block	Timing, sensitivity and D/L trimmers	S300-PR-5-C06-OC	951451100
			Sensitivity and D/L trimmers	S300-PR-1-C01-RX	951451110
		Timing, sensitivity and D/L trimmers; defogging function	Timing, sensitivity and D/L trimmers	S300-PR-1-C06-RX	951451120
			Sensitivity and D/L trimmers	S300-PR-1-C06-RX-M	951451130
Through beam receiver	NPN/PNP	Vdc - Terminal block	Sensitivity and D/L trimmers	S300-PR-2-F01-OC	951451210
			Timing, sensitivity and D/L trimmers	S300-PR-2-F06-OC	951451220
		Vdc - M12 Connector	Sensitivity and D/L trimmers	S300-PR-5-F01-OC	951451230
			Timing, sensitivity and D/L trimmers	S300-PR-5-F06-OC	951451240
	Relay	Vac - Terminal block	Sensitivity and D/L trimmers	S300-PR-1-F01-RX	951451250
			Timing, sensitivity and D/L trimmers	S300-PR-1-F06-RX	951451260
Through beam emitter		Vdc - Terminal block	Timing, sensitivity and D/L trimmers; defogging function	S300-PR-1-F06-RX-M	951451270
			Emission power regulation trimmer	S300-PR-2-G00-EX	951451280
			S300-PR-5-G00-EX	951451290	
		Vdc - M12 Connector	S300-PR-1-G00-EX	951451300	
			Defogging function	S300-PR-1-G00-EX-M	951451310
Background suppression	NPN/PNP	Vdc - Terminal block	Sensitivity and D/L trimmers	S300-PR-2-M01-OC	951451140
			Timing, sensitivity and D/L trimmers	S300-PR-2-M06-OC	951451150
		Vdc - M12 Connector	Sensitivity and D/L trimmers	S300-PR-5-M01-OC	951451160
			Timing, sensitivity and D/L trimmers	S300-PR-5-M06-OC	951451170
	Relay	Vac - Terminal block	Sensitivity and D/L trimmers	S300-PR-1-M01-RX	951451180
			Timing, sensitivity and D/L trimmers	S300-PR-1-M06-RX	951451190
		Timing, sensitivity and D/L trimmers; defogging function	S300-PR-1-M06-RX-M	951451200	

# MAXI SENSORS

## ACCESSORIES

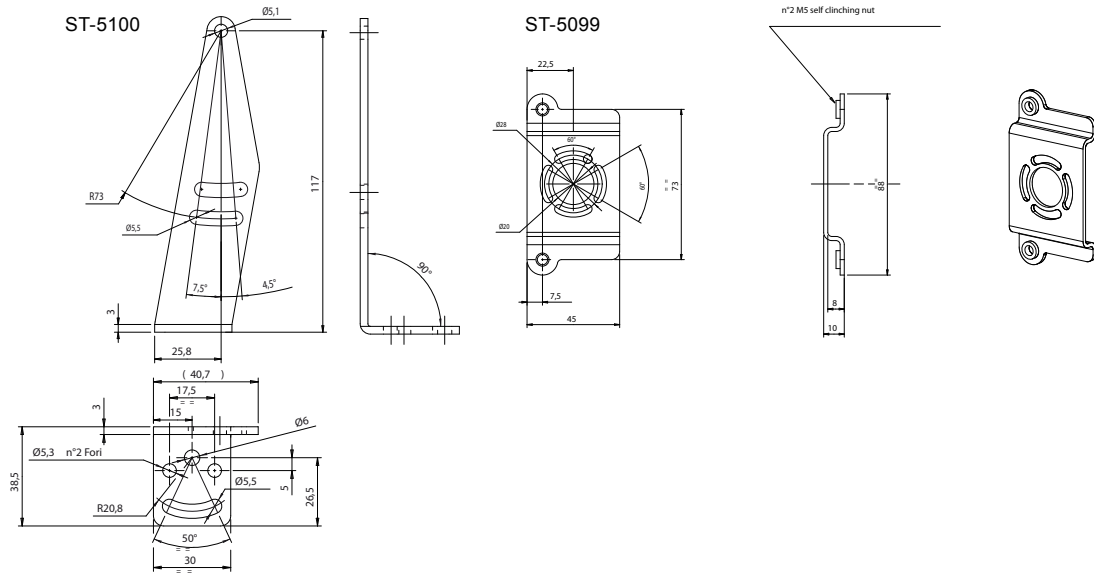

MODEL	DESCRIPTION	ORDER No.
ST-5099	mounting BRACKET	95ACC2830
ST-5100	mounting BRACKET	95ACC2840

## CABLES

TYPE	DESCRIPTION	LENGTH	MODEL	ORDER No.
Axial M12 Connector	4-pole, grey, P.V.C.	3 m	CS-A1-02-G-03	95A251380
		5 m	CS-A1-02-G-05	95A251270
		7 m	CS-A1-02-G-07	95A251280
		10 m	CS-A1-02-G-10	95A251390
	4-pole, P.U.R.	2 m	CS-A1-02-R-02	95A251540
		5 m	CS-A1-02-R-05	95A251560
Radial M12 Connector	4-pole, grey, P.V.C.	3 m	CS-A2-02-G-03	95A251360
		5 m	CS-A2-02-G-05	95A251240
		7 m	CS-A2-02-G-07	95A251245
		10 m	CS-A2-02-G-10	95A251260
	4-pole, P.U.R.	2 m	CS-A2-02-R-02	95A251550
		5 m	CS-A2-02-R-05	95A251570
Axial M12 Connector	4-pole, shielded, black, P.V.C.	3 m	CV-A1-22-B-03	95ACC1480
		5 m	CV-A1-22-B-05	95ACC1490
		10 m	CV-A1-22-B-10	95ACC1500
		15 m	CV-A1-22-B-15	95ACC2070
Radial M12 Connector	4-pole, shielded, black, P.V.C.	25 m	CV-A1-22-B-25	95ACC2090
		3 m	CV-A2-22-B-03	95ACC1540
		5 m	CV-A2-22-B-05	95ACC1550
		10 m	CV-A2-22-B-10	95ACC1560
Axial M12 Connector	4-pole, U.L., black, P.V.C.	3 m	CS-A1-02-U-03	95ASE1120
		5 m	CS-A1-02-U-05	95ASE1130
		10 m	CS-A1-02-U-10	95ASE1140
		15 m	CS-A1-02-U-15	95ASE1150
		25 m	CS-A1-02-U-25	95ASE1160
Radial M12 Connector	4-pole, black	Connector- not cabled	CS-A1-02-B-NC	G5085002
		Connector- not cabled	CS-A2-02-B-NC	G5085003

