

Large digit process indicator / controller
MAGNA 4 or 6-Digit Counter

Installation & Operating Manual

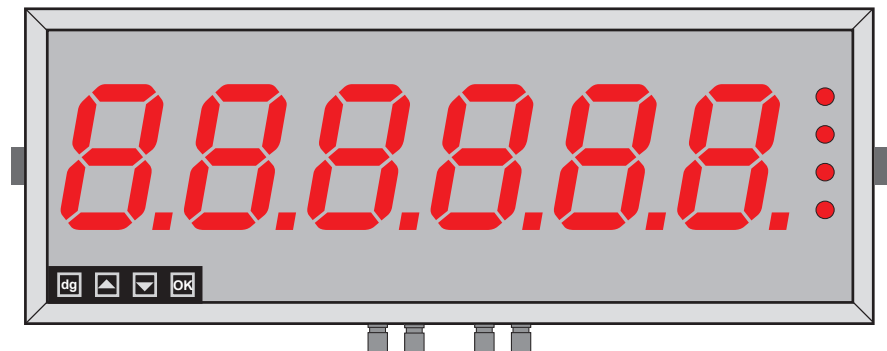

Caution: Risk of electrical shock if this instrument is not properly installed.

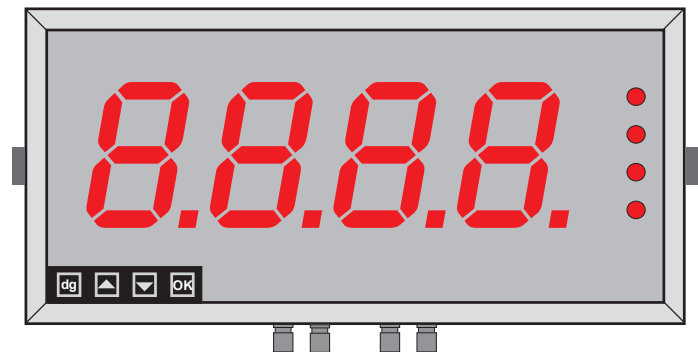

Caution: Read the whole manual before you install this display.

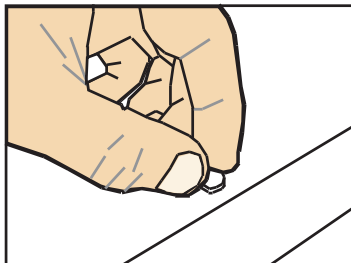

Rear case screws - please note

The rear panel is held in place with finger-screws, which only need to be gently tightened.

Do not use tools to tighten or loosen the screws, as this could cause damage to the internal threads.



LAUREL Electronics, Inc.

3183-G Airway Ave, Costa Mesa, CA 92626, USA

Tel +1 714-434-6131

Fax +1 714-434-3766

www.laurels.com

sales@laurels.com

Warranty

We warrant our products against defects in materials or workmanship for a period of one year from the date of purchase.

In the event of a defect during the warranty period, the unit should be returned, freight (and all duties and taxes) prepaid by the Buyer to the authorised distributor from where the unit was purchased.

The Distributor, at its option, will repair or replace the defective unit. The unit will be returned to the Buyer with freight charges prepaid by the distributor.

LIMITATION OF WARRANTY

The foregoing warranty shall not apply to defects resulting from:

1. Improper or inadequate maintenance by the buyer.
2. Unauthorised modification or misuse.
3. Operation outside the environmental specification of the product.
4. Mishandling or abuse.

The warranty set forth above is exclusive and no other warranty, whether written or oral is expressed or implied. We specifically disclaim the implied warranties of merchantability and fitness for a particular purpose.

EXCLUSIVE REMEDIES

The remedies provided herein are the buyer's sole and exclusive remedies.

In no event shall we be liable for direct, indirect, incidental or consequential damages (including loss of profits) whether based on contract, tort or any other legal theory.

Contents

Warranty	2
Warnings	4
Introduction	5
General Description	6
Suspension Mounting	7
Wall Mounting	8
Panel Mounting	9
Connections	10-11
Installation Hints for Best Performance	12-13
48V AC Power Option Wiring	14
Display Brightness	15
Input Signal Configuration	16
Input Signal Configuration Guide	17
Display Modes	18
Factory Defaults	19
Simple Rate mode	20-21
Period Mode	22-23
Totalizing Modes	24-25
Production Rate Mode	26-27
Quadrature Mode	28-29
Logic Input Functions	30
Logic Input Connections and Front Buttons	31
Signal Filtering / Averaging	32-33
Last Digit Rounding	34
Scale Factor Adjustment	35
Offset Adjustment	36
Menu Timeout Adjustment	37
Reverse / Mirror Display Setting	38
Bootup Routine Choices	39
Language Selection for User Interface	40
Multi Memory MEM Option	41
Error Codes	42
Output Options - Installing	43
WEEE	44
Equipment Specifications	45
Record of Revisions	46
Declaration of CE Conformity	47

Separate manuals for options

Alarm Option Settings	See Alarm manual *
Analog Output Option Settings	See Analog manual *
Serial Output Option Settings	See Serial manual *
Real Time Clock setting	See Serial manual *

* Need a manual urgently? Download manuals from our website.

Warnings

Please carefully read this manual and all warnings. Install the display ONLY when you are sure



Where the product is intended for “UL” installations, removal or addition of option boards is not permitted.



Check that the model number and supply voltage suit your application before you install the display.



Connect the display according to current IEE regulations, IEC61010 & NFPA:70 National Electric Code in USA.



Power supplies to this equipment must have anti-surge (T) fuses rated at 1A for 230V supply, 2A for 110V supply or 10A for DC supplies in the range 11-30VDC.



Don't touch any circuitry after you have connected the display, because there may be lethal voltages on the circuit board.



Do not apply power to the display if its case is open.



Only adjust on-board switches or connections with the power turned off



Make sure all screw terminals are tight before you switch the meter on.



Only clean the display's case and window with a soft damp cloth. Only lightly dampen with water. Do not use any other solvents.

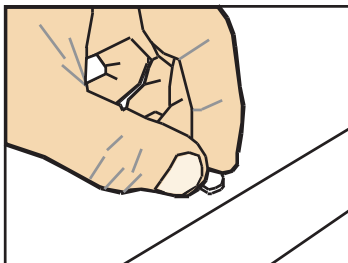

Rear case screws - please note

The rear panel is held in place with finger-screws, which only need to be gently tightened.

Do not use tools to tighten or loosen the screws, as this could cause damage to the internal threads.

Introduction

Please contact us if you need help, if you have a complaint, or if you have suggestions to help us improve our products or services.

If you contact us about a product you already have, please tell us the full model number and serial number, so that we can give you accurate and fast help.

This product has a 3 year warranty. We will put right or replace any display which is faulty because of bad workmanship or materials. This warranty does not cover damage caused by misuse or accident.

If you return a unit for repair, please include a detailed description of the problem, and the name of a contact who we can refer to for any questions. Please mark for the attention of the QA Department.

IMPORTANT

If this equipment is important to your process, you may want to buy a spare to cover possible failure or accidental damage in the future.

This is because during factory shutdown periods, you may have to wait several weeks for an equivalent replacement, or we may have no stock at the time you urgently need it.

You may also need to pay extra carriage charges if you want a fast, guaranteed courier service. Warranty repairs or replacements are usually returned with a standard courier service.

We do not offer compensation for losses caused by failure of this instrument.

If you do not agree with these conditions, please return this item in unused condition, in its original packaging and we will refund the purchase price, excluding any carriage paid.

We thought you'd prefer to know about possible delays and extra charges now, rather than during a panic. A spare unit could help to avoid these issues.

We always try to improve our products and services, so these may change over time. You should keep this manual safely, because future manuals, for new designs, may not describe this product accurately.

We believe these instructions are accurate, and that we have competently designed and manufactured the product, but please let us know if you find any errors.

General Description

This series of displays accepts industrial sensors to allow various physical measurements to be made, such as weight, temperature, pressure, humidity etc. Different models are available for different sensor types.

The main function of this series is to give a clear numeric readout of the variable being monitored. Most models include an excitation power output, to power the sensor directly.

Various digit heights are available, to suit the maximum viewing distance required in each installation. For every 10 metres (33 feet) of viewing distance, use 1" of digit height.

Various optional output modules are also available to give alarm relay outputs, analogue output or digital communications, or any combination of these options.

Displays are programmed using front panel pushbuttons. The front panel buttons can be disabled. In addition, you can connect 4 remote wired pushbuttons to the display, so that you can make adjustments while the display is mounted in an inaccessible location.

Displays have three power supply options : 100-240 VAC, 11-30VDC or 48V AC.

These displays must be installed fully assembled, and must be installed according to local electrical installation rules.

When properly installed, and provided they have been ordered with cable glands exiting the lower surface of the case, they provide ingress protection to IP65 / NEMA4X from all directions.

Safety



Caution: There is a risk of electrical shock if this display is not properly installed



Caution: Risk of danger: Read the whole manual before you install this display

Obey all safety warnings in this manual, and install the display according to local wiring and installation regulations. Failure to follow these guidelines may cause damage to the display, connected equipment, or may be harmful to personnel.

Any moving mechanical device controlled by this equipment must have suitable access guards to prevent injury to personnel if the display should fail.

Suspension Mounting Dimensions

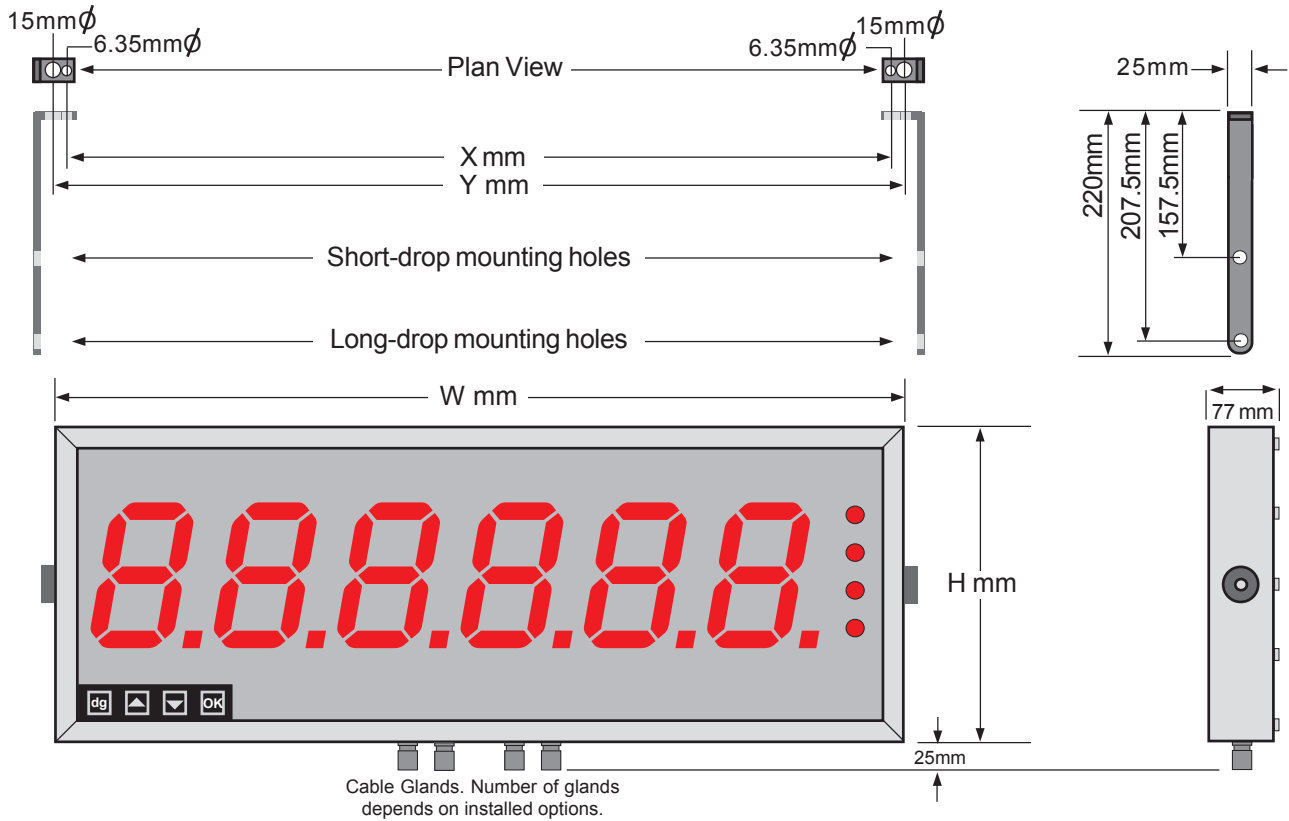

Detail showing bracket hardware fitting sequence

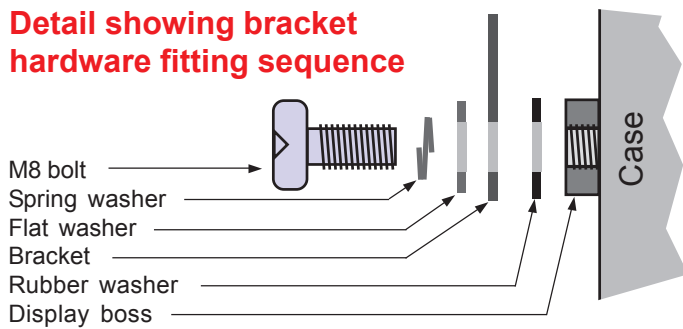

You can order these displays with the cable glands in the bottom surface (as shown) the rear, or top.

Rear glands allow you to mount the display on top of a cubicle, using the brackets shown.

Display Format	X mm	H mm	W mm	Y mm
2" 4 digit clock	245	154.5	291	275
2" 4 digit numeric	233.5	154.5	279.5	263.5
2" 6 digit clock	354	154.5	400	384
2" 6 digit numeric	330	154.5	376	360
4" 4 digit clock	407	195.5	453	437
4" 4 digit numeric	388	195.5	434	418
4" 6 digit clock	607	195.5	653	637
4" 6 digit numeric	570	195.5	616	600
6" 4 digit	534	246	580	564
6" 6 digit	774	246	820	804
8" 4 digit	704	290	750	734
8" 6 digit	1026	290	1072	1056
12" 4 digit	1004	408	1050	1034
12" 6 digit	1494	408	1540	1524
16" 4 digit	1322	515	1368	1352
16" 6 digit	1974	515	2020	2004

Wall Mounting Dimensions

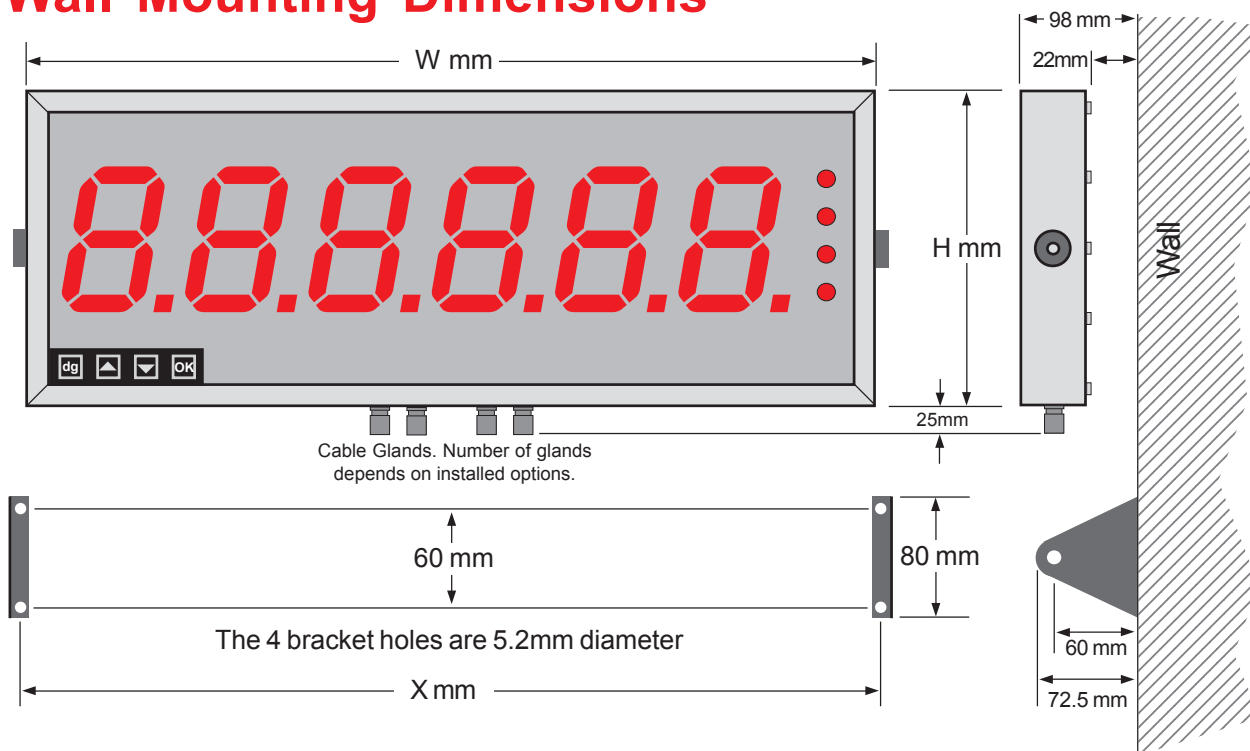

Detail showing bracket hardware fitting sequence

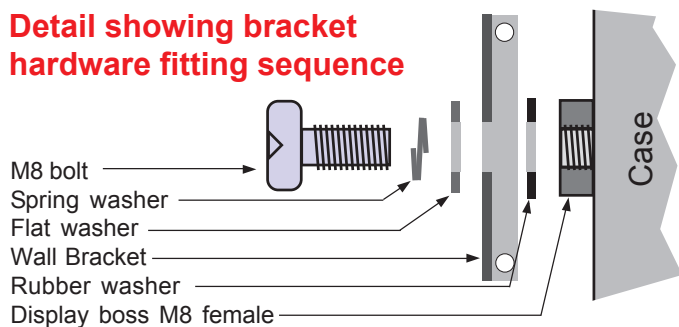

The side holes in the two brackets are 8.5mm dia. to accept M8 bolts.

Display Format	X mm	H mm	W mm
2" 4 digit clock	292	154.5	291
2" 4 digit numeric	280.5	154.5	279.5
2" 6 digit clock	401	154.5	400
2" 6 digit numeric	377	154.5	376
4" 4 digit clock	454	195.5	453
4" 4 digit numeric	435	195.5	434
4" 6 digit clock	654	195.5	653
4" 6 digit numeric	617	195.5	616
6" 4 digit	581	246	580
6" 6 digit	821	246	820
8" 4 digit	751	290	750
8" 6 digit	1073	290	1072
12" 4 digit	1051	408	1050
12" 6 digit	1541	408	1540
16" 4 digit	1369	515	1368
16" 6 digit	2021	515	2020

Panel Mounting Dimensions

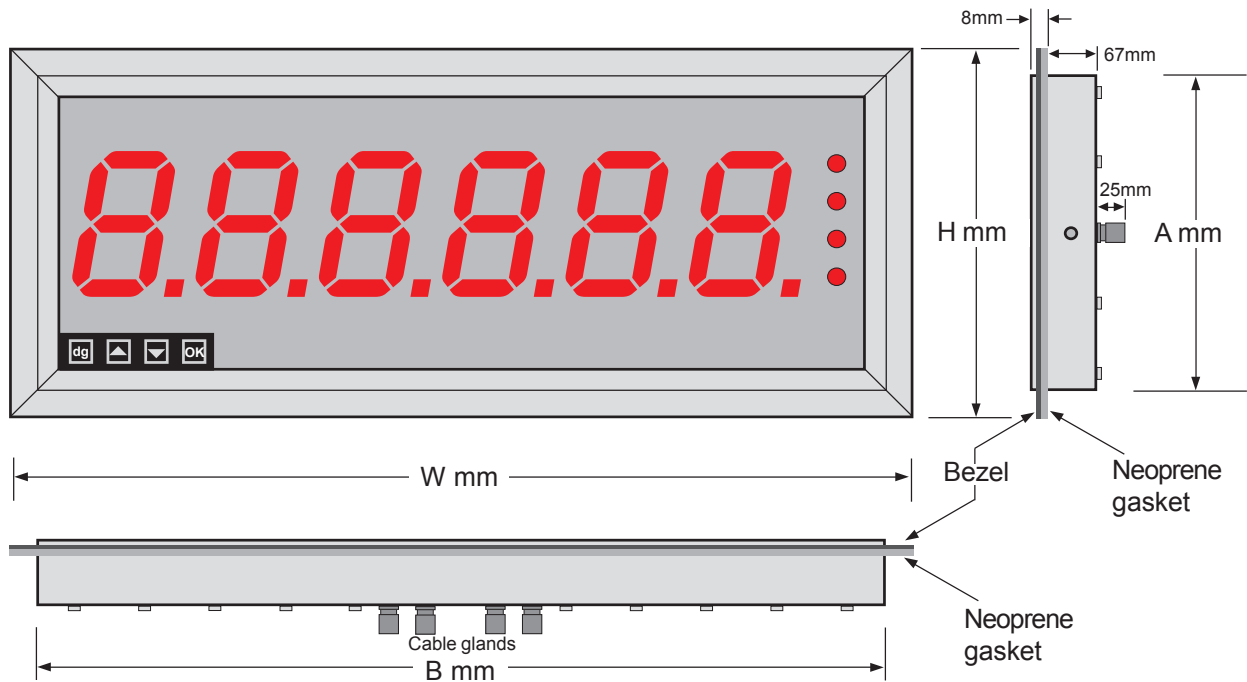

Detail showing bracket hardware fitting sequence

Panel cutout dimensions
 $A+3\text{mm}(h) \times B+3\text{mm}(w)$

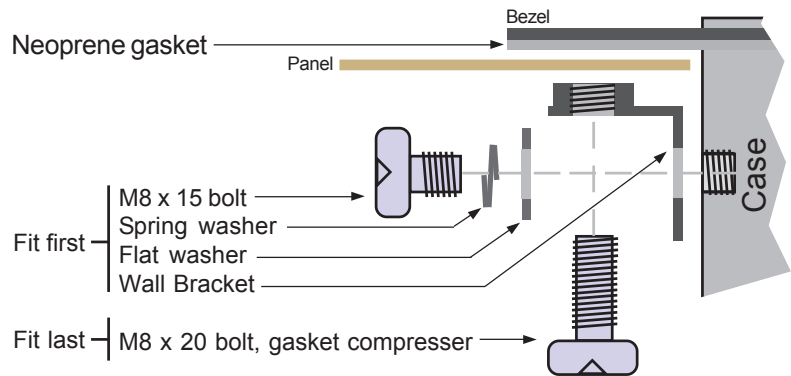

Display Format	H mm	A mm	B mm	Wmm
2" 4 digit clock	172.5	154.5	291	309
2" 4 digit numeric	172.5	154.5	279.5	297.5
2" 6 digit clock	172.5	154.5	400	418
2" 6 digit numeric	172.5	154.5	376	394
4" 4 digit clock	213.5	195.5	453	471
4" 4 digit numeric	213.5	195.5	434	452
4" 6 digit clock	213.5	195.5	653	671
4" 6 digit numeric	213.5	195.5	616	634
6" 4 digit	264	246	580	598
6" 6 digit	264	246	820	838
8" 4 digit	308	290	750	768
8" 6 digit	308	290	1072	1090
12" 4 digit	426	408	1050	1068
12" 6 digit	426	408	1540	1558
16" 4 digit	533	515	1368	1386
16" 6 digit	533	515	2020	2038

Connections



Warning:
Disconnect all power before removing the rear of the display

There is a wide range of possible locations for the input board, output board and power supply board/s. Their locations depend on the height of digits, number of digits, brightness of digits and any installed options. Because the permutation of possible locations is large, we will not describe the location of boards within the display, but simply identify the connectors and their functions on each board, below ...

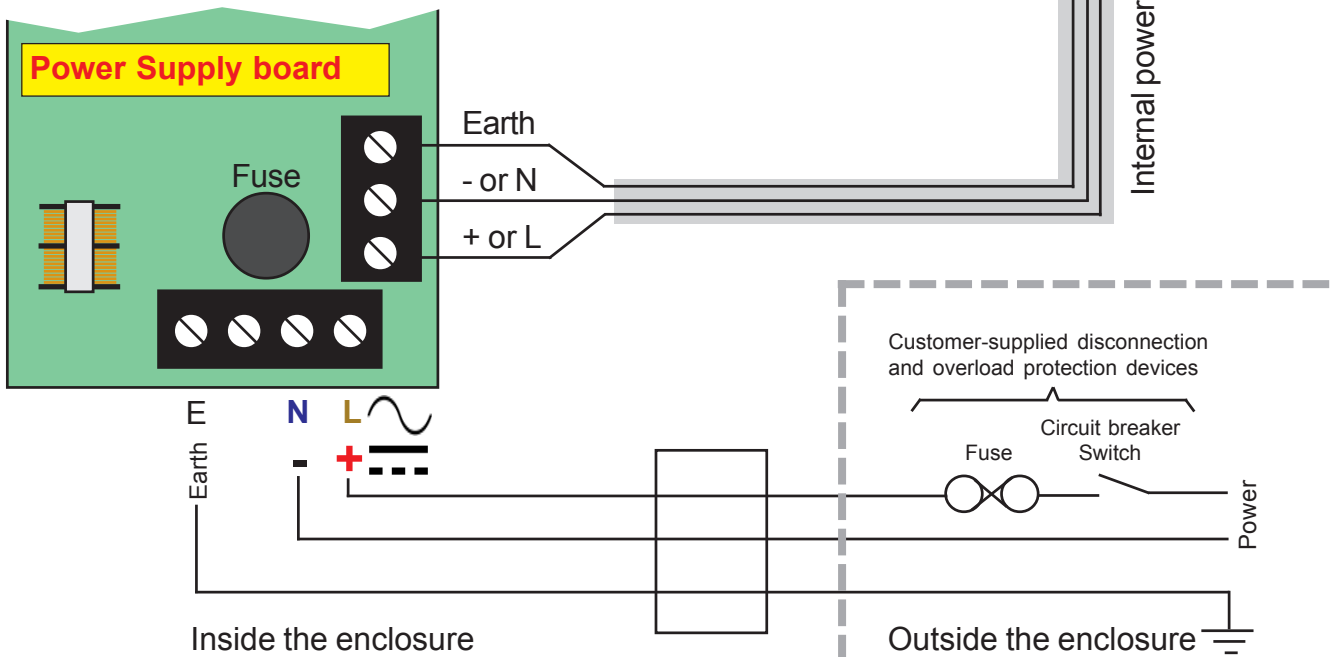
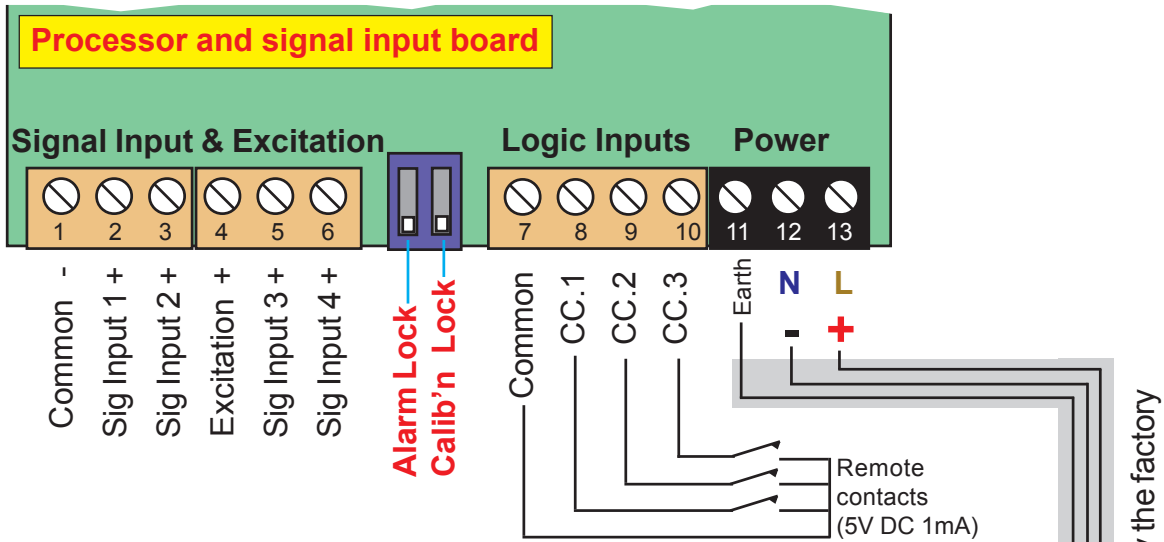

Connections

Warning:
Disconnect all power before removing the rear of the display

Connectors and options
Connectors may be present even if output options are not installed. Refer to rating label to see installed options.

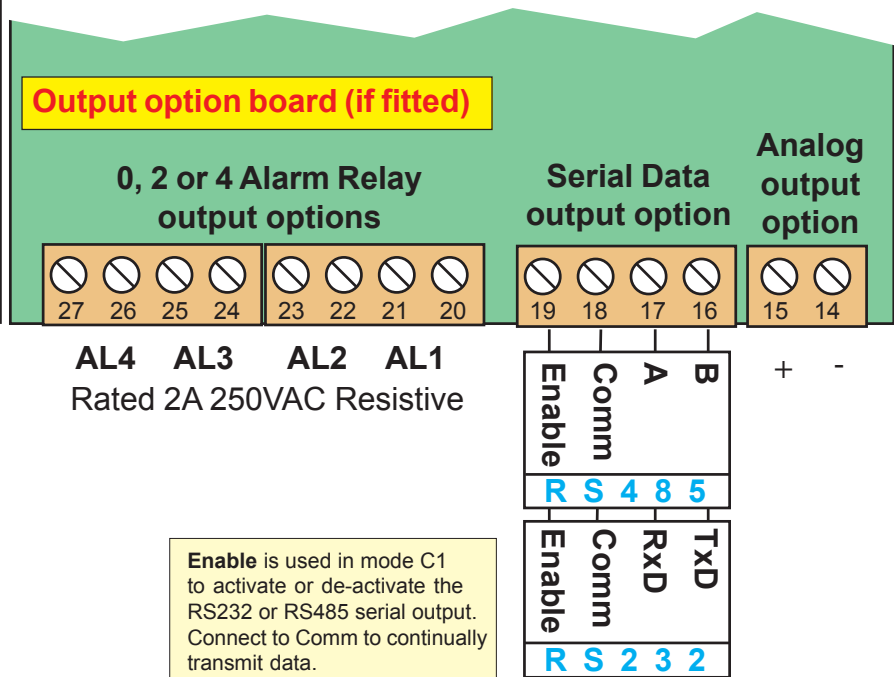

Remote programming button connector

On one of the display boards, you will find a 7 way connector, to which you can wire remote programming buttons, to allow adjustment of the display's settings when the display is inaccessible.

You can also enable or disable the display's front panel buttons, either by a remote contact closure, or by an on-board push-on jumper switch, which is located near to the remote button connector. When the contact is closed, or the push-on switch fitted, the front buttons are enabled.

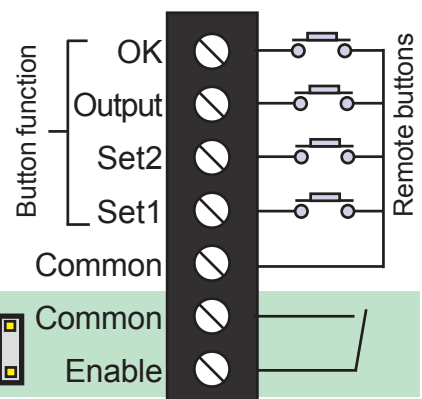

Close contact or fit jumper to enable front panel buttons

Display's front panel buttons enabled/disabled by jumper or connection

Common
Enable

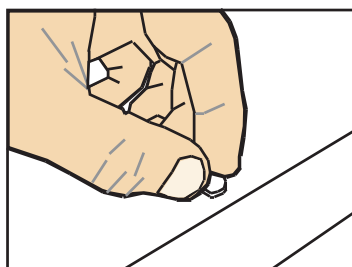

Rear case screws - please note

The rear panel is held in place with finger-screws, which only need to be gently tightened.

Do not use tools to tighten or loosen the screws, as this could cause damage to the internal threads.

Installation Hints for Best Performance

This section offers several suggestions which will help you get the best performance from your measurement system.

Some sensors generate comparatively small signals which can easily be corrupted by the potentially high level of electrical noise which can be created by electrical machinery such as motors, welding systems, discharge lighting, AC power inverters and solenoids. These steps will ensure you get the best possible performance from your system.

1. Use good quality screened signal cable, with twisted pairs. Belden 8777NH, Belden 9503 and AlphaWire 6010C are good choices, available from many electrical distributors.
2. If you are using multi-pair twisted cable, each pair should be dedicated to a single display as shown opposite, for maximum noise immunity. This will ensure that any electrical noise induced in the cable is properly cancelled. Mixing destinations carelessly amongst the twisted pairs can actually worsen noise performance.
3. The cable should be routed away from noisy wiring and devices such as power feeds from inverters, discharge-lighting cables, welder cabling etc, and should preferably be routed in a dedicated low voltage signalling/instrumentation conduit or cable tray.
4. Screened cable should be earthed at the display end only.
5. All wires and screens coming out of the screened cable should be kept as short as possible to minimise pickup of noise.
6. If you are using barriers, you should earth your screen as shown below, paying particular care that you do not earth both ends of any run of of cable.

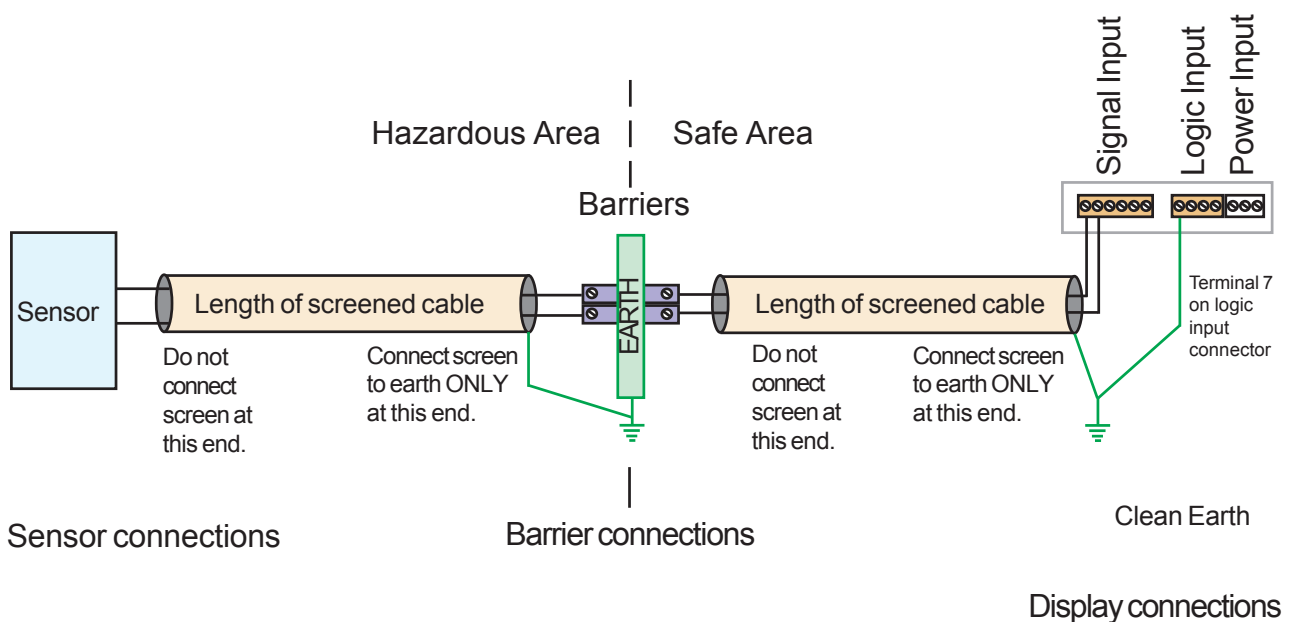

When using multi-core screened cable to connect several displays to several sensors, please be sure to use one twisted pair for each display and sensor.

Do NOT use a wire from one pair for signal positive and a wire from another pair for signal negative, as this will prevent the twisted cables from cancelling any induced electrical noise, and can couple noise from one channel to another.

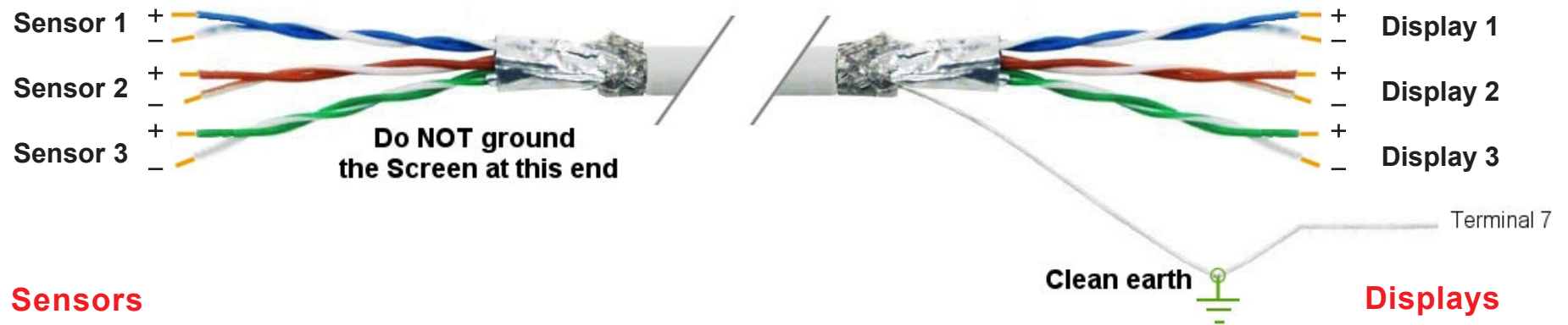

48V AC Power Wiring Option

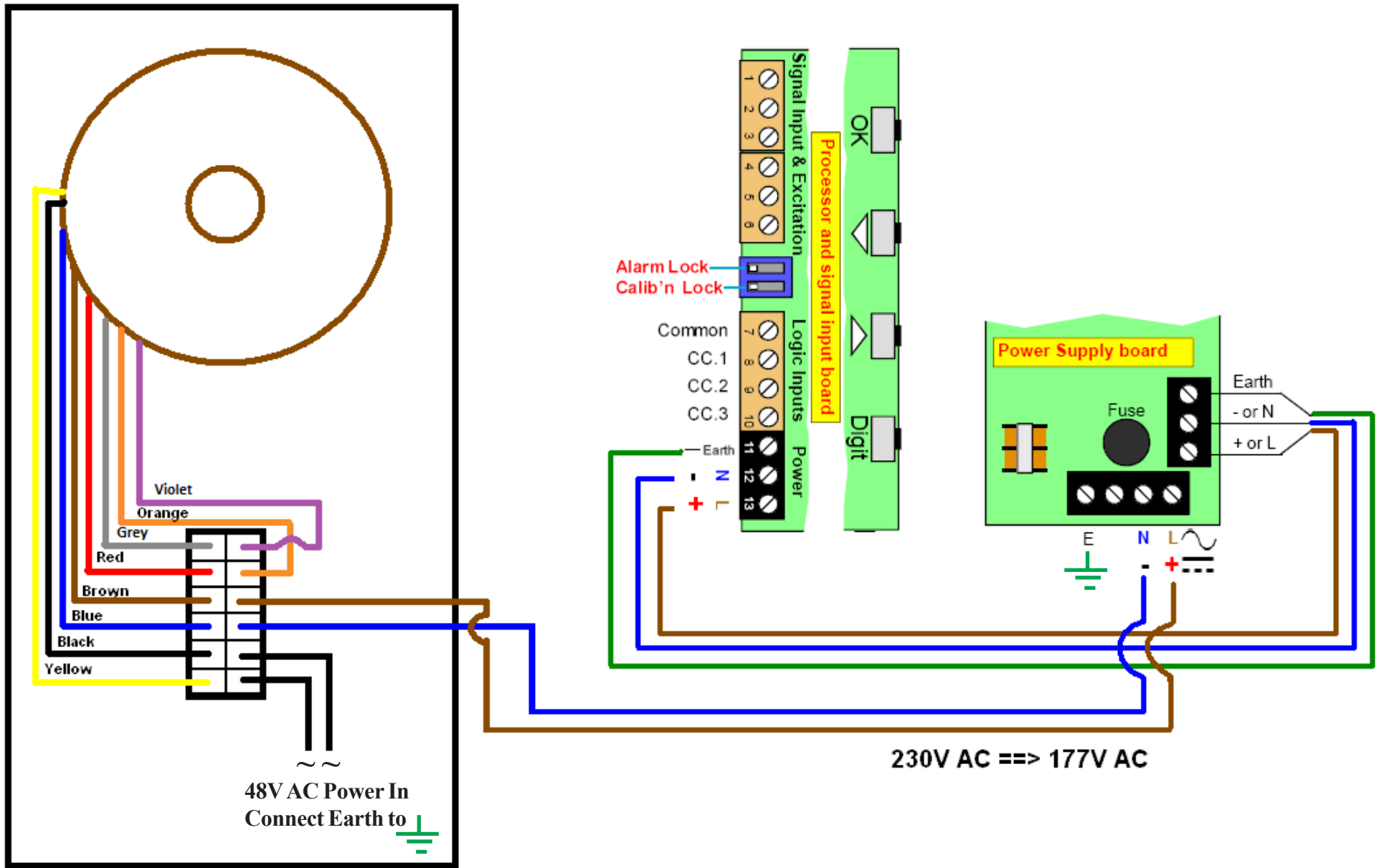

Display Brightness

You can adjust the display brightness at any time, provided the display is locked.

1

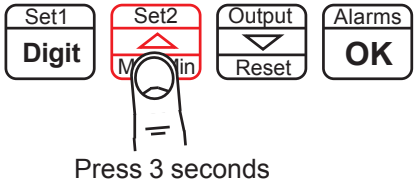

Press 3 seconds

Lockout Switch must be ON



Circuit board ON

2

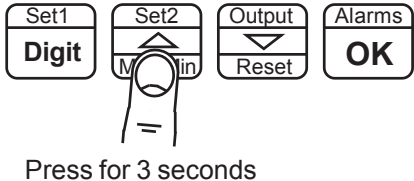

Press for 3 seconds

For 4 digits, display shows **br 1L**
For 6 digits, display shows **br 1ght**
Each press of the UP button selects a new brightness level. There are 7 brightness levels to choose from.
(Default = Full brightness)

3

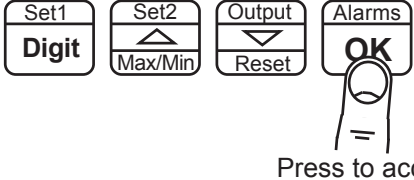

Press to accept

Done!



Did you know, we make this display in two brightness versions? Standard brightness for use inside, and Daylight Viewing for use outside in direct sunlight. Add MRDLV to the ordering number for outdoor brightness

Input Signal Configuration

Each of the display's 4 inputs can be configured to accept different types of input signals, using the procedure below....

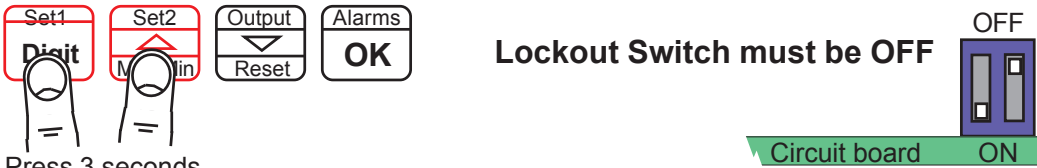
1  **Lockout Switch must be OFF**

Press 3 seconds

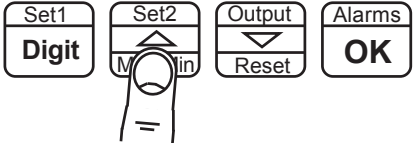
2  Display shows input channel choices:

- InP 1** Input 1
- InP 2** Input 2
- InP 3** Input 3
- InP 4** Input 4

Press to scroll through the available input channel choices and press OK to select.

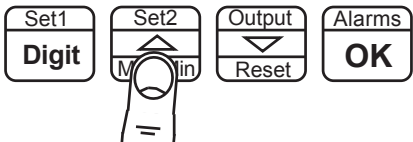
3  Display shows input signal type choices:

- DC.In** (4 digits) or **PuLS.dc** (6 digits)
DC pulses from 5 to 60V.
- Indu** (4 digits) or **induct** (6 digits)
Passive inductive sensors.
- AC.In** (4 digits) or **PuLS.AC** (6 digits)
AC signals up to 60V

Press to scroll through the available signal type choices and press OK to select.

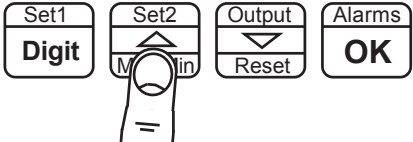
4  Display shows input signal loading choices:

- PuP** Pull up resistor activated
- PuD** Pull down resistor activated

Press to scroll through the available signal loading choices and press OK to select.

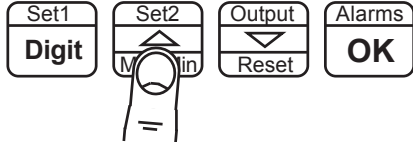
5  Display shows input debounce choices:

- dbn.1** (4 digits) or **dbn.On** (6 digits)
Contact debounce active.
- dbn.0** (4 digits) or **dbn.OFF** (6 digits)
Contact debounce inactive.

Press to scroll through the available debounce choices and press OK to select.

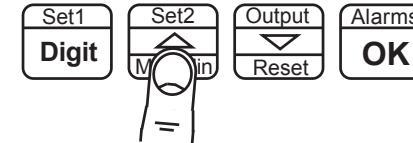
6  Display shows edge count choices in the following modes:

- 1in.u.d, 2in.u.d, 2in.u.u., 4 uudd, 4 uuuu, 4 dddd, quad.**
- Ed9.1** Count rising edge
- Ed9.0** Count falling edge

Press to select an Edge choice then press OK to accept.

 **Done!**

Input Signal Configuration Guide

This table tells you which settings to choose for each input signal type. The sensor should be connected to the display according to the connection diagram page.

Sensor family	Input Signal Type	Input signal loading	Input de-bounce
Contact closure	PuLS.dc	NPN	dbn.On
NPN	PuLS.dc	NPN	dbn.OFF
PNP/ Push-pull	PuLS.dc	PNP	dbn.OFF
TTL	PuLS.dc	NPN	dbn.OFF
CMOS	PuLS.dc	PNP	dbn.OFF
Passive coil	induct	PNP	dbn.OFF
AC Tacho	PuLS.AC	PNP	dbn.OFF

Excitation Output: 24V DC nominal rated at 60 mA, to power sensors (standard).
 10V DC at 120 mA Max (optional), 5V DC at 30 mA max (optional).

Signal I/P & Excitation

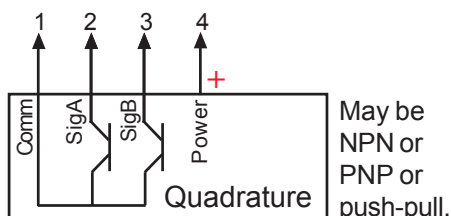
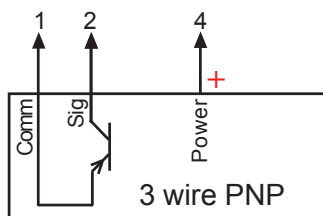
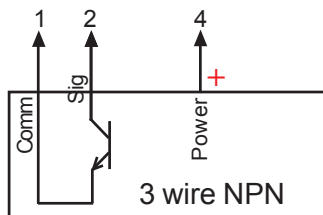
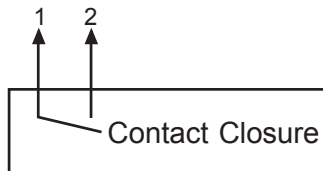
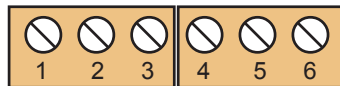

Signal I/P & Excitation

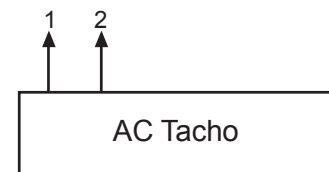
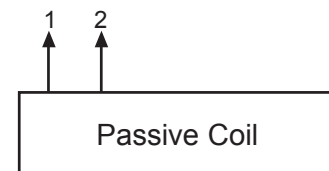
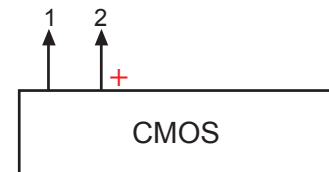
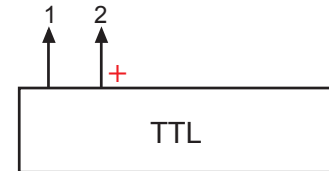

Display Modes

You can choose from eleven basic display modes, some of which have extra sub-modes.

1

Press 3 seconds

Lockout Switch must be OFF

Circuit board ON

2

Press to scroll through the available mode choices.

Each mode has a separate section to describe its operation in detail.

When you have chosen a mode, press OK to select.

For 4 digits, display shows:

rAtE	Rate, Frequency, RPM
PEr	Intervals, bake time
tOt	Counting
gAt.t	Gated counting
1 i. u.d.	1 input, Up/Down control
2 i. u.d.	2 in, Up/Down
2 i. u.u.	2 in Up, Up
uudd	4 in , Up, Up, Down, Down
uuuu	4 in, Up, Up, Up, Up
dddd	4 in Down, Down, Down, Down
QuAd	Quadrature

2

Press to scroll through the available mode choices.

Each mode has a separate section to describe its operation in detail.

When you have chosen a mode, press OK to select.

For 6 digits, display shows:

rAtE	Rate, Frequency, RPM
PEr iod	Intervals, bake time
tOtAL	Counting
gAtEd.t	Gated counting
1 in. u.d.	1 input, Up/Down control
2 in. u.d.	2 in, Up/Down
2 in. u.u.	2 in Up, Up
4 uudd	4 in , Up, Up, Down, Down
4 uuuu	4 in, Up, Up, Up, Up
4 dddd	4 in Down, Down, Down, Down
QuAd	Quadrature

3

Press to accept

Done!

Factory Defaults

You can return the display to its factory default conditions whenever you wish. If you do so, you will permanently lose all your settings and will need to start from the beginning again.

The calibration Audit Counter will NOT be reset, there is no way provided to reset this value, as it is intended as a secure record to indicate whether changes have been made to the display since it was last calibrated..

1

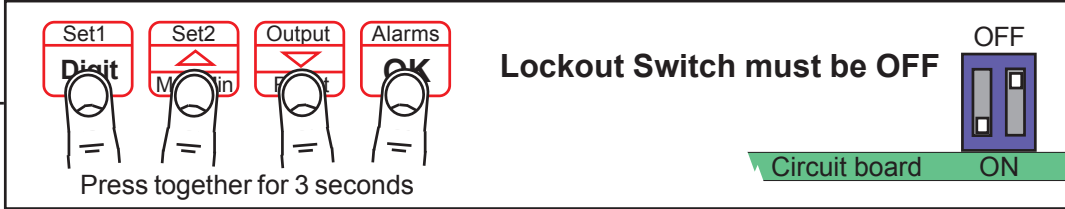

Set1 Digit Set2 Max/Min Output Reset Alarms OK

Lockout Switch must be OFF

Circuit board ON

Press together for 3 seconds

2

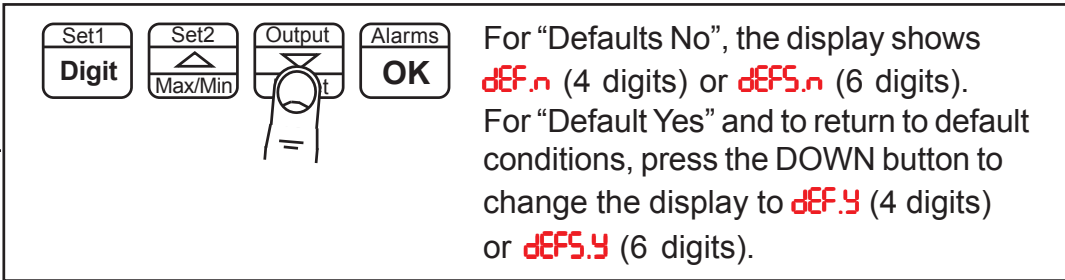

Set1 Digit Set2 Max/Min Output Reset Alarms OK

For "Defaults No", the display shows **dEF.n** (4 digits) or **dEFS.n** (6 digits).
For "Default Yes" and to return to default conditions, press the DOWN button to change the display to **dEF.Y** (4 digits) or **dEFS.Y** (6 digits).

3

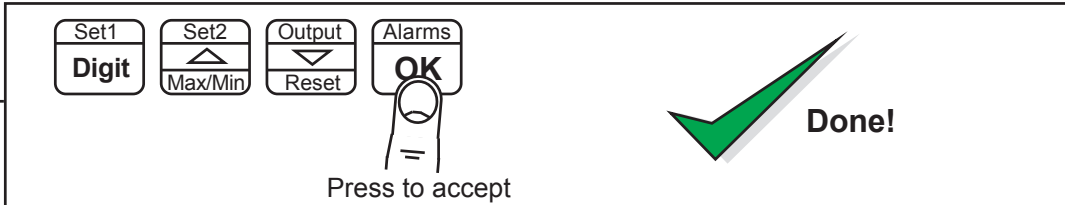

Set1 Digit Set2 Max/Min Output Reset Alarms OK

Press to accept

Done!

Calibration Audit Number

Your display includes a non-resettable counter which increments each time you make a change to the display's calibration. This is useful if you want to check whether a display has been altered since it was last calibrated.

The Calibration audit number starts at **CL01** up to **CLFF** (4 digits) or at **CAL01** up to **CALFF** (6 digits) allowing up to 255 alterations to be recorded. Whenever you want to check the calibration audit number, press and hold the 2 outer buttons (Set1 + Alarms) for more than 3 seconds.

1

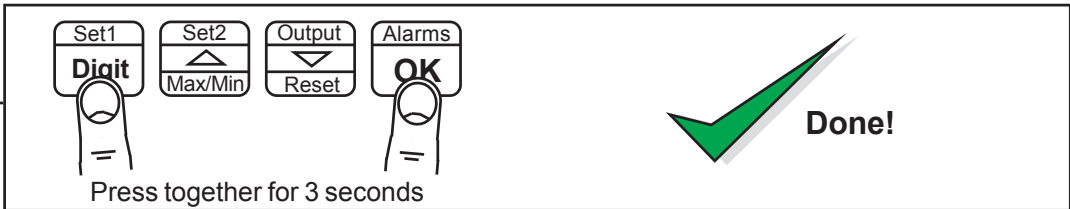

Set1 Digit Set2 Max/Min Output Reset Alarms OK

Press together for 3 seconds

Done!

Simple Rate Mode

Rate mode is ideal for showing instantaneous speed, RPM, frequency, production rate, flow rate etc. For production rate showing the true number of items produced in the last hour, consider using our 'Production Rate Mode' method, which is ideal for production which is erratic or has periods of widely differing production rate.

- 1**

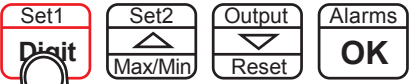

Press 3 seconds

Lockout Switch must be OFF



Circuit board ON
- 2**

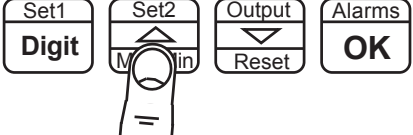

Press to scroll through the available mode choices. Select **rAtE** and press OK
- 3**



Fr. in (4 digits) or **FrEQ. in** (6 digits) will appear, prompting you to enter a frequency in Hz, which will correspond to a desired display value. Use Digit, Up and Down buttons to set, and press OK to accept.

You can move the decimal point during setting by pressing the UP button for a few seconds, then repeatedly press to shift the position.
- 4**

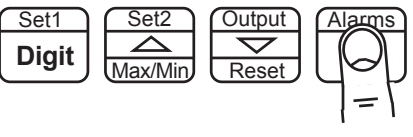

d.SP will appear, prompting you to enter a display value, which will correspond to the frequency you entered. Use Digit, Up and Down buttons to set, and press OK to accept.

You can move the decimal point during setting by pressing the UP button for a few seconds, then repeatedly press to shift the position.
- 5**

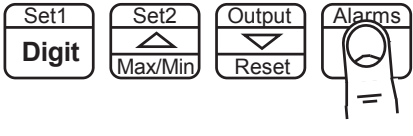

Av. 00 (4 digits) or **Av9. 00** (6 digits) will appear, prompting you to enter a number of readings to average, from 00 to 99. The bigger the number, the smoother the display, but the response to change will be slower.
- 6**

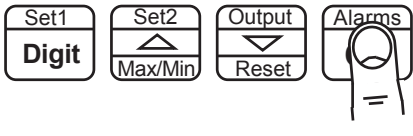

dL03 (4 digits) or **dEL 03** (6 digits) will appear, prompting you to enter a delay time in seconds, so that if no pulses are received within this time, the display will revert to showing 0.
- 7**

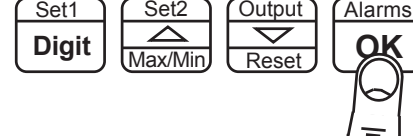

Press to accept



Done!

Application Notes - Rate Mode

RPM Measurements

We can accept any number of pulses per rotation, from 1 upwards.

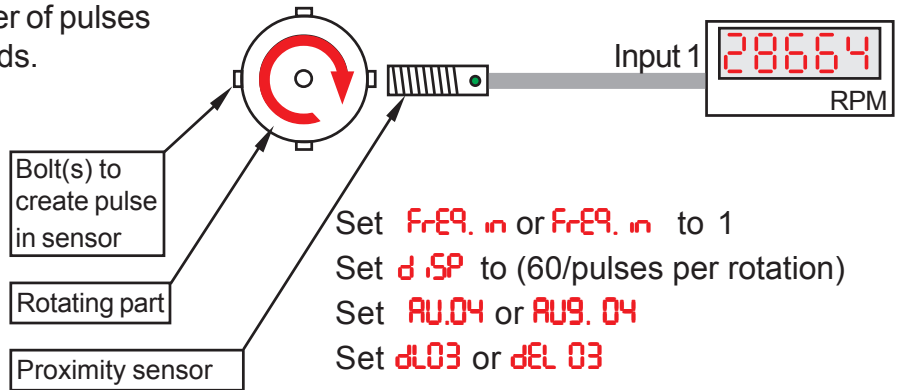

Frequency Measurements

Ideal for the precision measurement of generator or inverter grid frequency.

A simple step-down transformer can be used to drop the line voltage down to a level suitable for the display.

5V to 30V AC is ideal.

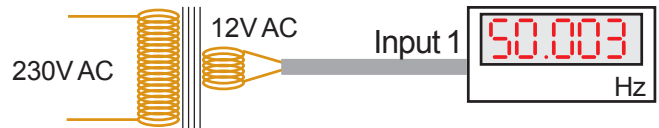

Set $Fr.in$ or $FrE9.in$ to 1

Set $d.SP$ to 1.000

Set $AU.04$ or $AU9.04$

Set $dL03$ or $dEL 03$

Flow Rate Measurements

Accepts pulses from turbine flowmeters, positive displacement flowmeters.

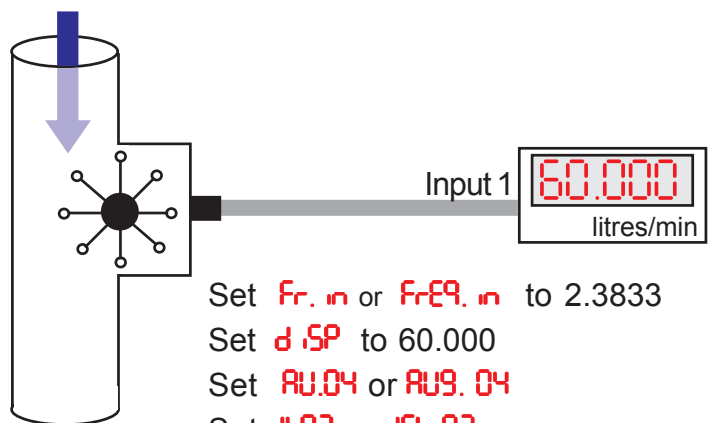

Has flexible scaling to suit any relationship between pulses per unit volume.

Example 143 pulses per litre, show liters per minute



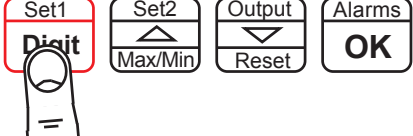

Period Mode

Rate mode is ideal for showing instantaneous speed, RPM, frequency, production rate, flow rate etc. For production rate showing the true number of items produced in the last hour, consider using our 'Binned Rate' method, which is ideal for production which is erratic or has periods of widely differing production rate.

1  **Lockout Switch must be OFF**  **Circuit board ON** 

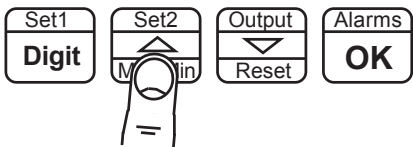
Press 3 seconds

2  Press to scroll through available mode choices. Select **PEr** (4 digits) or **PEr iOd** (6 digits), and press OK.

3  **PEr .** (4 digits) or **PEr .i** (6 digits) will appear, prompting you to enter a period in milliseconds, which will correspond to a desired display value. Use Digit, Up and Down buttons to set, and press OK to accept.

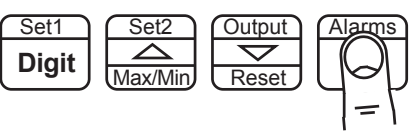

You can move the decimal point during setting by pressing the UP button for a few seconds, then repeatedly press to shift the position.

4  **d.5P** will appear, prompting you to enter a display value, which will correspond to the period in milliseconds you entered. Use Digit, Up and Down buttons to set, and press OK to accept.

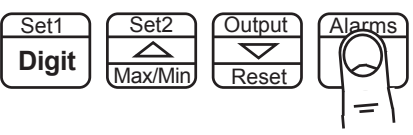
You can move the decimal point during setting by pressing the UP button for a few seconds, then repeatedly press to shift the position.

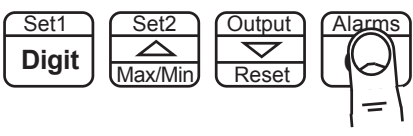
5  **Av. 00** (4 digits) or **Av9. 00** (6 digits) will appear, prompting you to enter a number of readings to average over, from 00 to 99.

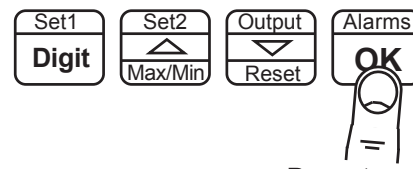
6  **dL03** (4 digits) or **dEL 03** (6 digits) will appear, prompting you to enter a delay time in seconds, so that if no pulses are received during this time, the display will revert to 0

7  **Done!** 



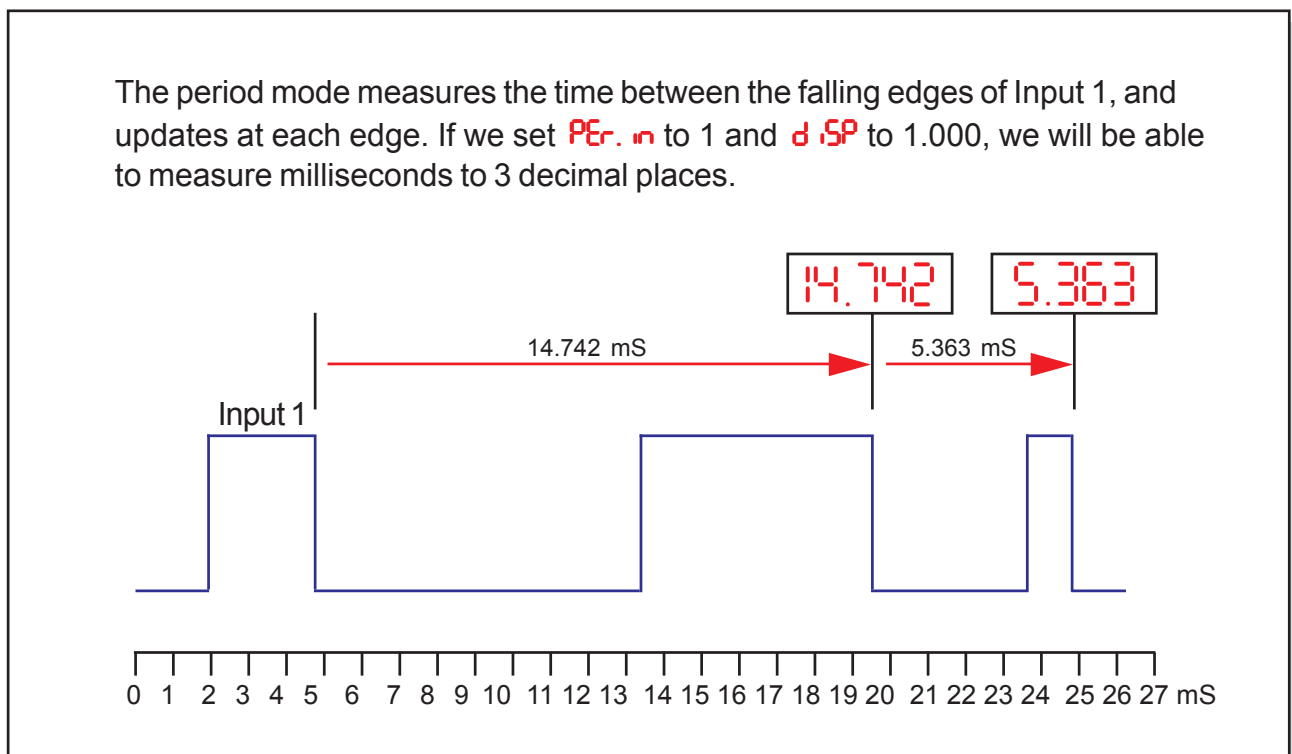
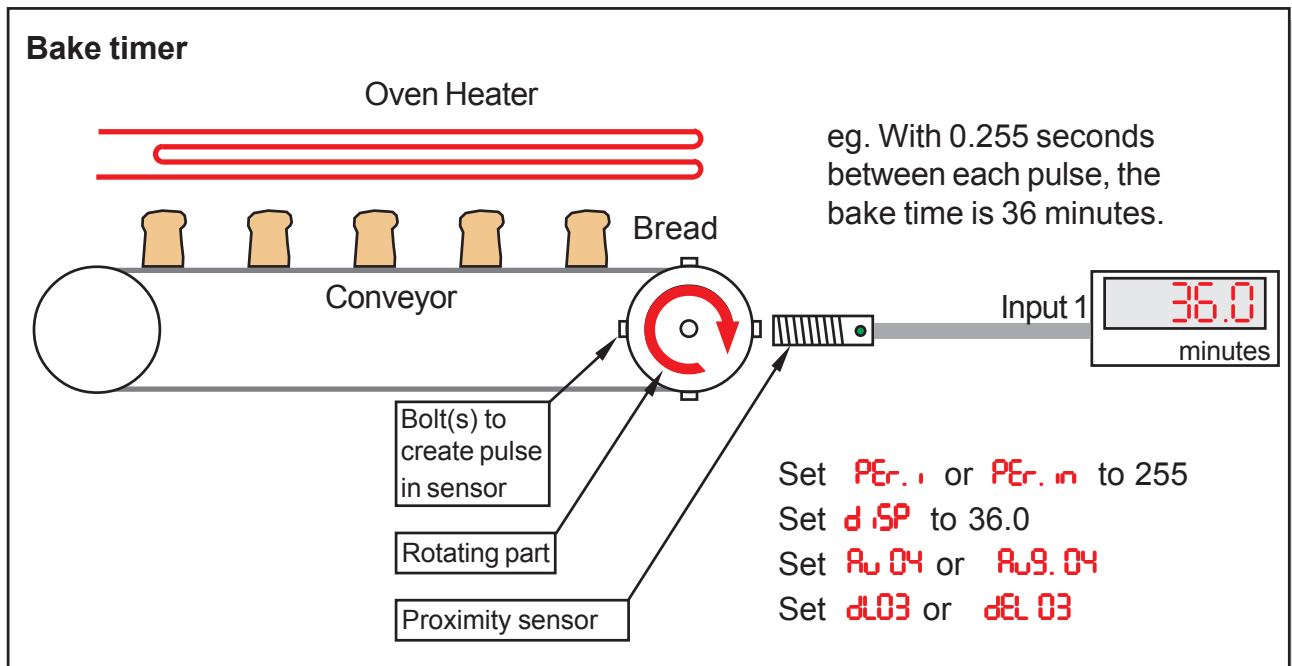

Press to accept

Application Notes - Period Mode

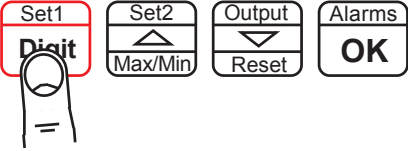

Totalizing Modes

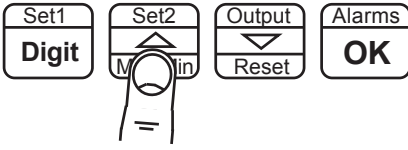
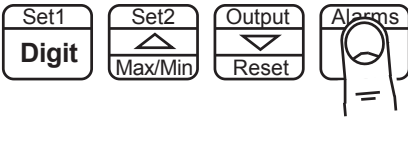
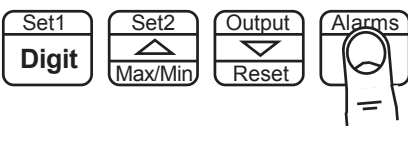
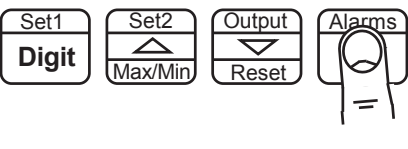
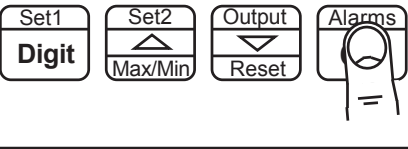
There are several useful totalizing modes available, which use 1 or more of the display's logic input ports. The total will be stored on loss of power, and will be restored when power is returned to the display.

1	 <p>Press 3 seconds</p>	<p>Lockout Switch must be OFF</p>  <p>Circuit board ON</p>
2		<p>Press to scroll through the available mode choices. Choose from these modes (described opposite).</p> <p>For 4 digits: tot, 9At.t, 1.u.d, 2.u.d., 2.u.u., uudd, uuuu, dddd</p> <p>For 6 digits: totAL, 9AtEd.t, 1 in u.d, 2 in. u.d., 2 in. u.u., 4 uudd, 4 uuuu, 4 dddd</p>
3		<p>inPP (4 digits) or PuLS in (6 digits) will appear, prompting you to enter a number of input pulses, which will correspond to a desired display value. Use Digit, Up and Down buttons to set, and press OK to accept.</p> <p>You can move the decimal point during setting by pressing the UP button for a few seconds, then repeatedly press to shift the position.</p>
4		<p>d.SP will appear, prompting you to enter a display value, which will correspond to the number of input pulses you entered. Use Digit, Up and Down buttons to set, and press OK to accept.</p> <p>You can move the decimal point during setting by pressing the UP button for a few seconds, then repeatedly press to shift the position. A negative value will give down counting.</p>
5		<p>PrES (4 digits) or PrESEt (6 digits) will appear, prompting you to enter a reset value. The display will revert to this value whenever it is reset. Often used to count down from the preset to 0.</p>
6		<p>PrES (4 digits) or Pr.LoAd (6 digits) will appear, prompting you to enter a value, if required. You can preload a count number here. This value will disappear if you reset the display.</p>
7	 <p>Press to accept</p>	 <p>Done!</p>

Totalizing Modes - Application Notes

The 8 totalizing modes are ideal for counting pulses, where 1 pulse = 1 item, or the total can be scaled, for example to show total flow of liquid, where 1 pulse may represent a certain volume of liquid according to the relationship between "PULS in" and "d,SP"

tot or **total**

Totalizer (simple)

Pulses on input 1 are counted and scaled.

Signal I/P & Excitation

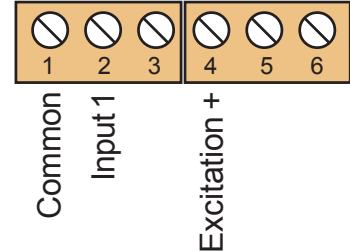

gAt.t or **gAtEd.t**

Gated Totalizer

Pulses on input 1 are counted and scaled, provided Input 2 is low. When input 2 is held high, pulses on Input 1 are ignored.

Signal I/P & Excitation

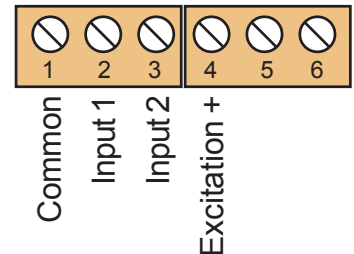

1 in u.d or **1 in d**

1 Input, Up/Down Totalizer

Pulses on input 1 are counted and scaled. When input 2 is held high, pulses on Input 1 are added. When input 2 is held low, pulses on Input 1 are subtracted.

Signal I/P & Excitation

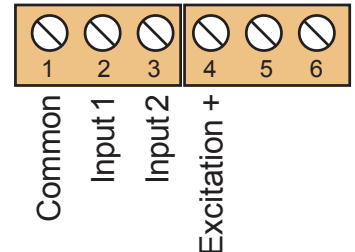

Multi Input, Up/Down Totalizer

2 i.u.d. or **2 in. u.d.**

= Count up on input 1, count down on input 2.

2 i.u.u. or **2 in. u.u.**

= Count up on input 1, count up on input 2.

4 u.d. or **4 in u.d.**

= Count up on inputs 1 & 2, count down on inputs 3 & 4.

uuuu or **4 uuuu** = Count up on inputs 1, 2, 3 and 4.



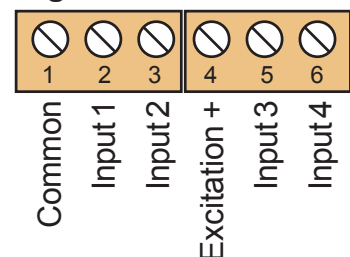

dddd or **4 dddd** = Count down on inputs 1, 2, 3 and 4.

Signal I/P & Excitation

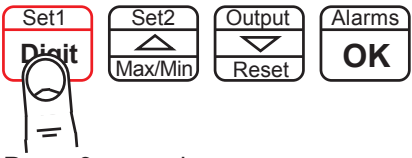

Production Rate Mode

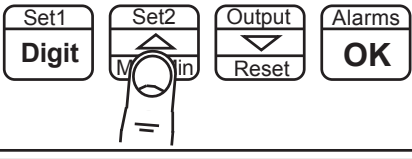
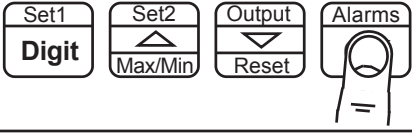
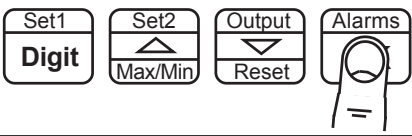
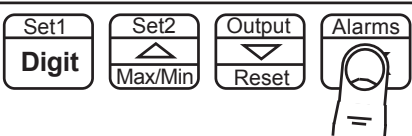
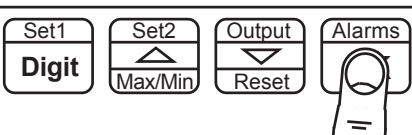
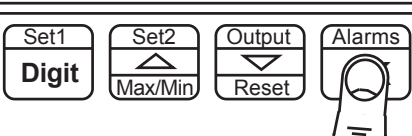
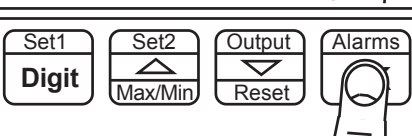
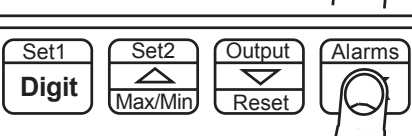
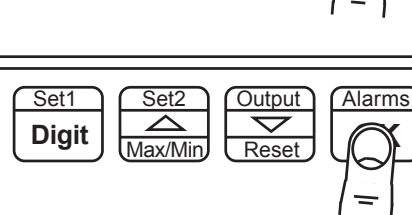
In this mode four inputs are available, two can add to give a combined total, and two can subtract to give combined rejects. This mode of rate measurement is ideal for showing real production rates over longer periods, for example showing items per hour, for the previous hour, updated every 15 seconds, 5 minutes, or whatever best suits your process.

1	 <p>Press 3 seconds</p>	<p>Lockout Switch must be OFF</p>  <p>Circuit board ON</p>
2		<p>Press to scroll through the available mode choices. Select uudd. (4 digits) or 4 uudd. (6 digits), and press OK.</p>
3		<p>inPP (4 digits) or PuLS in (6 digits) will appear, prompting you to enter a number of pulses, normally set to 1.</p>
4		<p>d.SP will appear, prompting you to enter a display value, normally set to 1.</p>
5		<p>PrES (4 digits) or Pr-ESet (6 digits) will appear, prompting you to enter a number to start counting from. Normally set to 0.</p>
6		<p>PrLd (4 digits) or Pr.LoAd (6 digits) will appear, prompting you to enter a value to pre-load the counter with. Normally set to 0.</p>
7		<p>b in.t will appear, prompting you to enter a value in seconds for the bin time. Default is 10. This is the display's update time in seconds. See opposite for a guide how to choose the best value.</p>
8		<p>b in.L (4 digits) or b in.Lnt (6 digits) will appear, prompting you to enter a value for the number of bins to use. Default is 0, maximum is 200. See opposite for a guide how to choose the best value.</p>
9		<p>SCALE (4 digits) or SCALE (6 digits) will appear, prompting you to enter a scale factor, to allow the readout to be presented in items per minute, per hour, per shift, per day etc. See opposite for a guide how to choose the best value.</p>
10		<p style="text-align: right;"> Done!</p>

Application Notes for Production Rate Mode

1. Choose an averaging time, in seconds, you want to use for computing your production rate.

For example if you want to average over 45 minutes, your averaging time will be 2700 seconds.

We need to calculate an update time for your display, we will have up to 200 samples available in your averaging period.

Update time = $2700/200 = 13.5$
Round this up to the nearest whole number.
This is set in the variable **bin.t = 14**
Set **bin.cnt = 200**

This means that your display will update every 14 seconds in this case.

NB If your averaging time is less than 3 minutes, please use the formula:

Update time = averaging time/20 , round up to nearest whole number = **bin.t**
Set **bin.cnt = 20**

2. We now need to set a scale factor so that your display reads correctly in items per hour, per minute or per second.

The scale factor settings will be....

For items per second = **SCALE** = $1/\text{bin.t}$
For items per minute = **SCALE** = $60/\text{bin.t}$
For items per hour = **SCALE** = $3600/\text{bin.t}$
For items per shift = **SCALE** = $28800/\text{bin.t}$
For items per day = **SCALE** = $86400/\text{bin.t}$

For an online calculator to choose the best settings for you, please see <http://tinyurl.com/6cljcr6>

Quadrature Mode

The quadrature mode allows you to scale a count and increase or decrease the value according to the sequencing of two pulses which are 90 degrees out of phase. This mode is ideal for measuring distance in pay-out/feed-in cable systems, or direction in rotary systems.

- 1**

Press 3 seconds

Lockout Switch must be OFF
- 2**

Press to scroll through the available mode choices. Select **QuAd** and press OK to accept
- 3**

InP (4 digits) or **PULS in** (6 digits) will appear, prompting you to enter a number of input pulses, which will correspond to a desired display value. Use Digit, Up and Down buttons to set, and press OK to accept.

You can move the decimal point during setting by pressing the UP button for a few seconds, then repeatedly press to shift the position.
- 4**

d.SP will appear, prompting you to enter a display value, which will correspond to the number of input pulses you entered. Use Digit, Up and Down buttons to set, and press OK to accept.

You can move the decimal point during setting by pressing the UP button for a few seconds, then repeatedly press to shift the position. A negative value will give down counting.
- 5**
- 6**

PrES (4 digits) or **Pr-ESet** (6 digits) will appear, prompting you to enter a reset value. The display will revert to this value whenever it is reset. Often used to count down from the preset to 0.
- 7**

PrLo (4 digits) or **Pr.LoAd** (6 digits) will appear, prompting you to enter a value, if required. You can preload a count number here. This value will disappear if you reset the display.
- Press to accept

Done!

Quadrature Mode - Application Notes

In a quadrature sensor, the two incoming pulses overlap. Pulses to input 1 will arrive before or after pulses to input 2, depending on the direction of movement. This is achieved by staggering the trigger zones for sensor A and B. They must overlap, so that one will lead the other in one direction, and vice-versa. Trigger zones on large rotating wheels can be bolt heads or holes. In small angular encoders, the trigger zones are normally etched into a thin disc or are photographically produced to make light and dark areas.

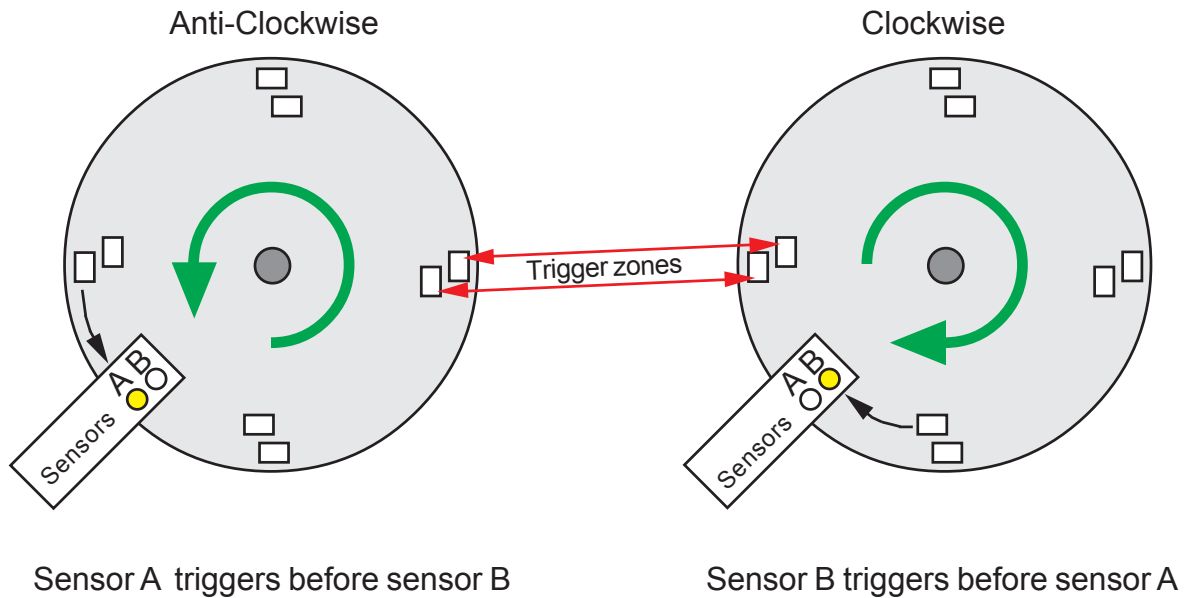

In the simplified arrangement shown above, we get 4 pulses per revolution, because we have 4 pairs of triggers. The angular resolution we get with this arrangement is 90 degrees. Some sensors have 1024 pulses per revolution, giving 0.35 degree resolution, but there are many different arrangements available. Our scheme above would be typical in cable laying applications, where it is more important to count revolutions of the drum than to know its absolute angle. The trigger zones can also be arranged in a straight line instead of around a circumference, to create a sensor for linear displacement.

Please be sure to check that the sensor's maximum output frequency is kept to less than 10 000 pulses per second.



Quadrature counter

Pulses on input 1 are counted and scaled, with directional information decided by detecting whether pulses for Input 2 arrive before or after pulses for Input 1

Signal I/P & Excitation

1	2	3	4	5	6
Common	Input 1 = A	Input 2 = B	Excitation +		

Logic Input Functions

The three contact closure logic inputs have default functions which are:-

- Contact closure 1 = Tare
- Contact closure 2 = Peak/Valley display
- Contact closure 3 = Reset

You can re-assign these to include :HOLD, Nett/Gross value display, Memory page address 1, 2 or 4 (only if Multi-memory MEM option is installed).

1

Set1
Digit

Set2
Max/Min

Output
↓

Alarms
OK

Lockout Switch must be OFF



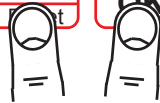

Press briefly together

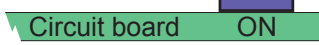

Circuit board ON

2

Set1
Digit

Set2
Max/Min

Output
Reset

Alarms
OK

Press repeatedly until you see **CC. 1**, followed by the existing function for Contact Closure 1.

After you have set **CC. 1**, you will get the prompt **CC. 2** to allow you to set Contact Closure 2 function and when you have set CC.2 you will get the prompt **CC. 3** to allow you to set Contact Closure 3 function



3

Set1
Digit

Set2
Max/Min

Output
Reset

Alarms
OK

Use UP or DOWN buttons to select from these available functions:

tArE	= Tare display to 0
PU	= Peak/Valley toggle
rSt	= Reset
HoLd	= Freeze display
ne.Gr	= Net / Gross display (4 digits)
ne.Gro	= Net / Gross display (6 digits)
PA. 1	= Page Address 1*
PA. 2	= Page Address 2*
PA. 4	= Page Address 4*

Defaults are:-

CC. 1 = tArE
CC. 2 = PU
CC. 3 = rSt

4

Set1
Digit

Set2
Max/Min

Output
Reset

Alarms
OK

Done!





Press to accept

* Only available if the Multi-memory MEM option is installed

Logic Input Connections and Front Buttons

The previous page explained how to select the functions of the 3 logic inputs. You can connect remote contact closures or open NPN collectors to activate these logic inputs.

The logic input provides a 5V DC signal. When you connect this to common, a current of 1mA will flow. Because this is a small signal, we recommend you use switches with gold plated contacts, or self cleaning contacts, for best long term reliability.

The logic inputs are not galvanically isolated from the input signal.

The logic inputs are only activated when the lockout switch is ON

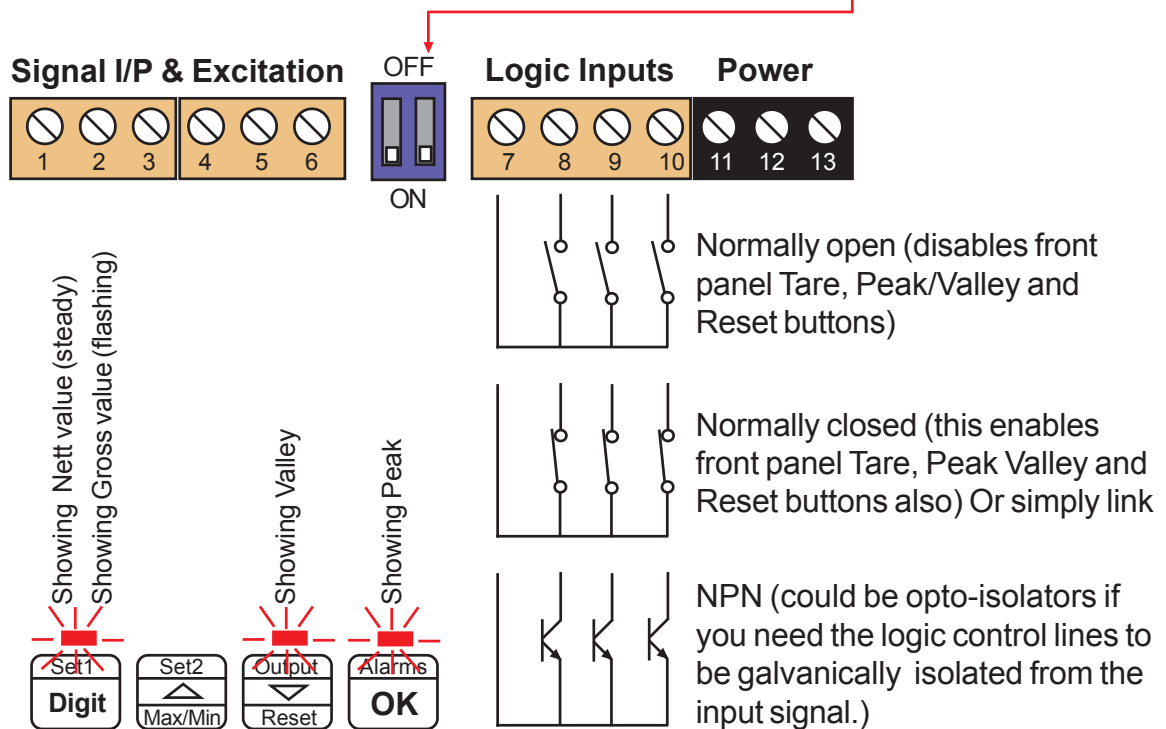

- TARE** = Tares display to 0. Often used in weighing systems to zero a display prior to making a measurement. Net weight is shown once tared. When a display has been tared, the small LED above the Set1 button will be illuminated.
- PU** = Peak/Valley toggle. Allows you to view the maximum and minimum values which have been displayed since last reset. 0% LED illuminates when showing valley, 100% LED illuminates when showing peak.
- rst** = Reset. This clears any tare, peak, valley, alarm latch.
- Hold** = Freezes the displayed value for as long as the Hold input is closed.
- nt.gr** = Toggles between Net and Gross values on the display (4 digits).
- nt.gr0** = Toggles between Net and Gross values on the display (6 digits).
- PA. 1 .. 4** = Page Addresses, if MEM option is installed.

Signal Filtering / Averaging

You can adjust the filtering time constant to reduce the effect of noise or instability on your input signal.

A larger FIL value will give a more stable display, but the response to signal changes will be slower.

Because your output options, such as analogue output, alarm relays and serial output are all derived from the displayed value, they will respond at the same rate as the filtered display.

1

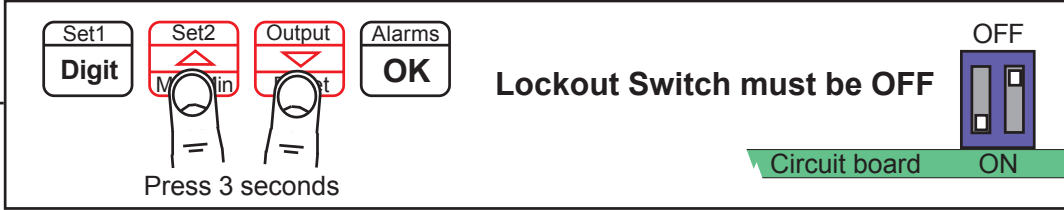

Set1 Digit Set2 Max/Min Output Min/Max Alarms OK

Lockout Switch must be OFF

Circuit board ON

Press 3 seconds

2

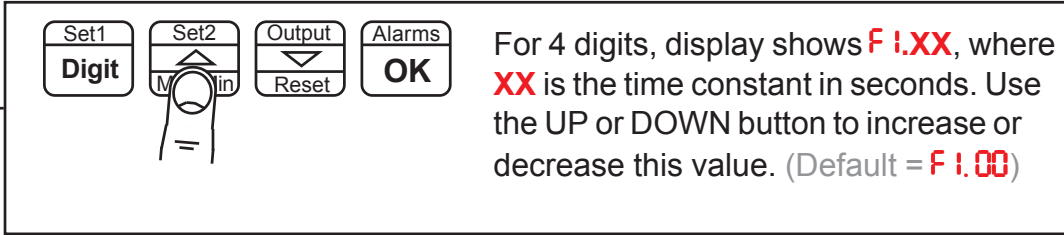

Set1 Digit Set2 Max/Min Output Min/Max Alarms OK

For 4 digits, display shows **F I.XX**, where **XX** is the time constant in seconds. Use the UP or DOWN button to increase or decrease this value. (Default = **F I.00**)

2

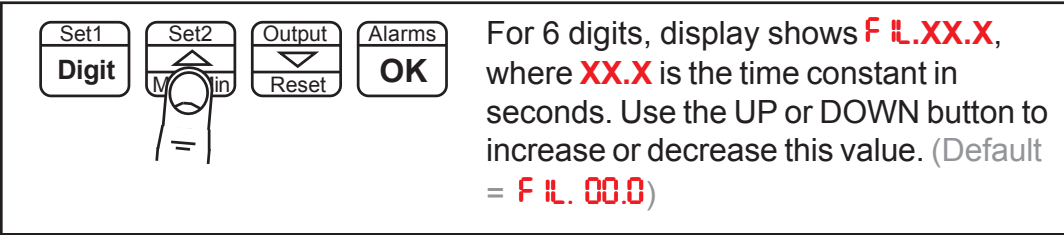

Set1 Digit Set2 Max/Min Output Min/Max Alarms OK

For 6 digits, display shows **F IL.XX.X**, where **XX.X** is the time constant in seconds. Use the UP or DOWN button to increase or decrease this value. (Default = **F IL.00.0**)

3

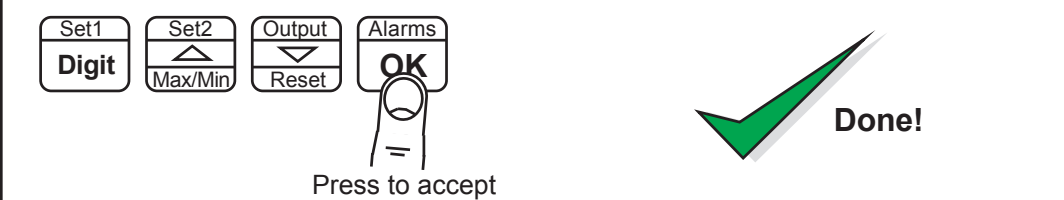

Set1 Digit Set2 Max/Min Output Min/Max Alarms OK

Done!

Press to accept

See also Filter Jump setting if your signal is particularly noisy and you cannot get sufficient smoothing with this filter.

Filter Jump Value

The Filter Jump value allows you to decide how the display will respond to a process step change. It does this by overriding the filtering, if the input signal moves by more than a chosen amount in one conversion. The Filter Jump default value is 10%.

This means that for noise amplitude which has a peak value of less than 10% of the input range, filtering will be applied. Any signal movement greater than 10% of the input range will cause the display to jump immediately to that value, without filtering. After that jump, normal filtering will be re-applied, provided signal movement thereafter is less than 10% per conversion.

Guidance:

For noisy systems, increase the Filter Jump value up to a maximum of 99. Choose a value which gives a good compromise between filtering and response speed.

For reasonably clean signals, a Filter Jump value of around 10 or less will give a good compromise between filtering and response speed to step change inputs.

1

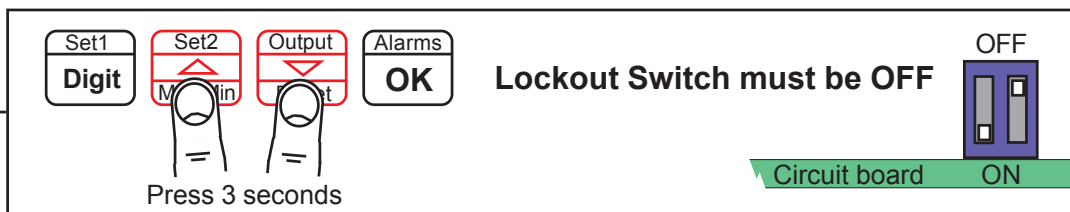

Set1 Digit Set2 Max/Min Output Reset Alarms OK

Press 3 seconds

Lockout Switch must be OFF

Circuit board ON

2

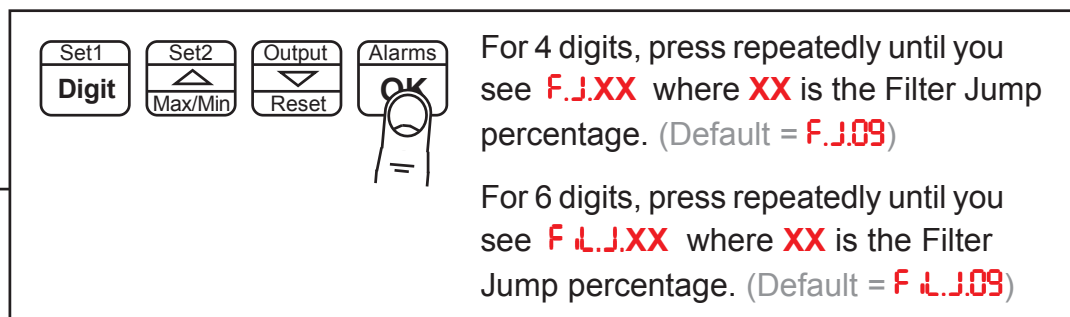

Set1 Digit Set2 Max/Min Output Reset Alarms OK

For 4 digits, press repeatedly until you see **F.J.XX** where **XX** is the Filter Jump percentage. (Default = **F.J.09**)

For 6 digits, press repeatedly until you see **F.L.J.XX** where **XX** is the Filter Jump percentage. (Default = **F.L.J.09**)

3

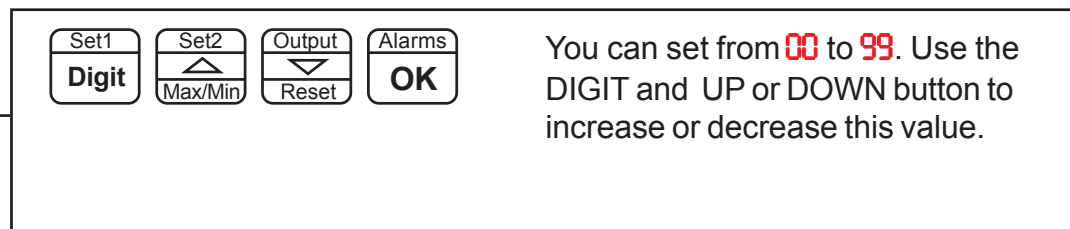

Set1 Digit Set2 Max/Min Output Reset Alarms OK

You can set from **00** to **99**. Use the DIGIT and UP or DOWN button to increase or decrease this value.

4

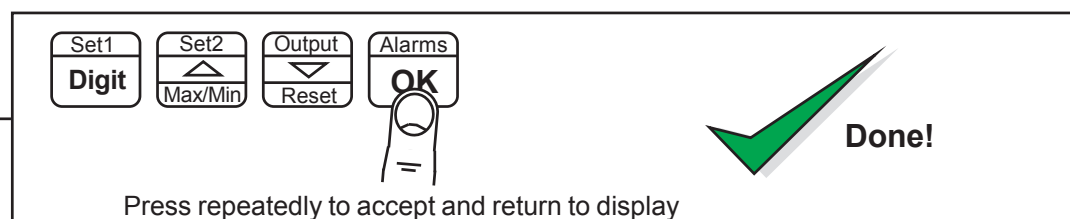

Set1 Digit Set2 Max/Min Output Reset Alarms OK

Done!

Press repeatedly to accept and return to display

Last Digit Rounding Up by 1, 2, 5, 10, 20 or 50

You can adjust the way the display rounds up, which is useful if you want to display a very large number, but do not want jitter on the last digit.

The display can be set to round up to the nearest 1 (no rounding) 2, 5, 10, 20 or 50

1

Set1 Digit Set2 Set2 Output Output Alarms OK

Press 3 seconds

Lockout Switch must be OFF

Circuit board ON

2

Set1 Digit Set2 Max/Min Output Reset Alarms OK

For 4 digits, press repeatedly until you see **F.J.XX** where **XX** is the Filter Jump percentage. (Default = **F.J.09**)

For 6 digits, press repeatedly until you see **F.L.J.XX** where **XX** is the Filter Jump percentage. (Default = **F.L.J.09**)

3

Set1 Digit Set2 Max/Min Output Reset Alarms OK

You can set from **00** to **99**. Use the DIGIT and UP or DOWN buttons to increase or decrease this value.

4

Set1 Digit Set2 Max/Min Output Reset Alarms OK

Press repeatedly to accept and return to display

Done!

Scale Factor Adjustment

After you have calibrated your display, you can use the SCALE feature to make fine adjustments to calibration, without affecting the calibration itself.

Example

Changing volume units of measure from litres to Imperial gallons

You could also use the SCALE to convert your readout from litres to imperial gallons, without affecting the calibration. Simply set SCALE = 0.220 and your meter which was calibrated in liters will now read in imperial gallons.

- 1**

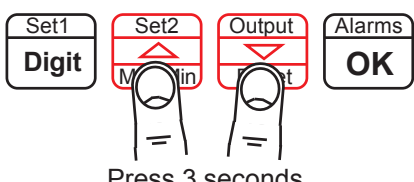

Set1 Digit Set2 Max/Min Output Min/Max Alarms OK

Press 3 seconds

Lockout Switch must be OFF



Circuit board ON
- 2**

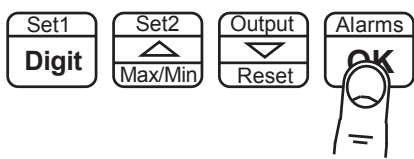

Set1 Digit Set2 Max/Min Output Min/Max Alarms OK

For 4 digits, press repeatedly until you see **SCAL**, followed by the existing scale factor. (Default = **00 1.0**)

For 6 digits, press repeatedly until you see **SCALE**, followed by the existing scale factor. (Default = **00 1.000**)
- 3**



Set1 Digit Set2 Max/Min Output Min/Max Alarms OK

Use DIGIT button to select each digit in turn, UP or DOWN buttons to increase or decrease each digit's value. Press OK when done.
- 4**

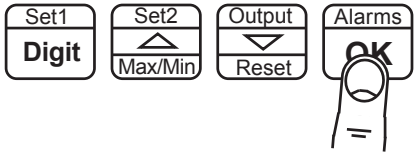

Set1 Digit Set2 Max/Min Output Min/Max Alarms OK

Press to accept



Done!

You may want to adjust an offset value also, see separate OFFSET page for this feature.

Offset Adjustment

After you have calibrated your display, you can use the **OFFSET** feature to make fine additions or subtractions to the reading, without affecting the calibration itself.

1

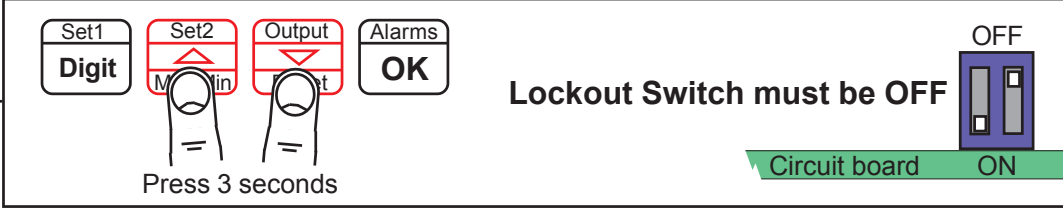

Set1 Digit Set2 Max/Min Output Reset Alarms OK

Press 3 seconds

Lockout Switch must be OFF

Circuit board ON

2



Set1 Digit Set2 Max/Min Output Reset Alarms OK

Press repeatedly until you see **OFF.St** (4 digits) or **OFFSEt** (6 digits), followed by the existing offset value. (Default is **000.0** for 4 digits or **000.000** for 6 digits)

3

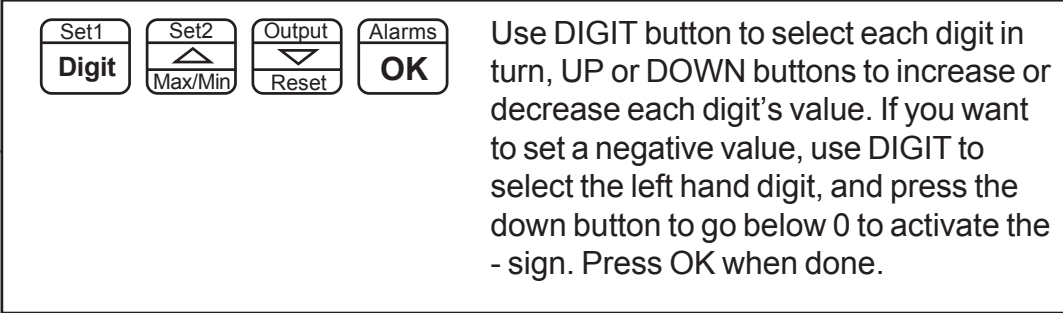

Set1 Digit Set2 Max/Min Output Reset Alarms OK

Use DIGIT button to select each digit in turn, UP or DOWN buttons to increase or decrease each digit's value. If you want to set a negative value, use DIGIT to select the left hand digit, and press the down button to go below 0 to activate the - sign. Press OK when done.

4

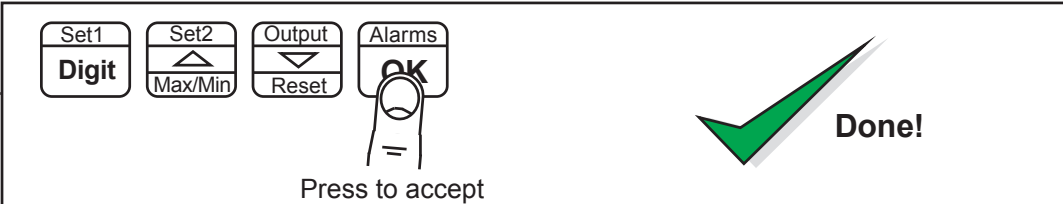

Set1 Digit Set2 Max/Min Output Reset Alarms OK

Press to accept

Done!

You may want to adjust a SCALE FACTOR value also, without affecting calibration. See the separate SCALE page for this feature.

Menu Timeout Adjustment

The display has a default timeout of 60 seconds, to allow you sufficient time to refer to the manual between key operations.

You can make this period shorter, if you wish, once you become more familiar with the setup method.

1

Set1 Digit Set2 Max/Min Output Alarms

Press together, briefly

Lockout Switch must be OFF

Circuit board ON

2

Set1 Digit Set2 Max/Min Output Reset Alarms OK

Press repeatedly until you see **dY. XX** (4 digits) or **dLAY. XX** (6 digits), where **XX** is the delay in seconds. Choices are:

- dY. 10** or **dLAY. 10**
- dY. 20** or **dLAY. 20**
- dY. 30** or **dLAY. 30**
- dY. 60** or **dLAY. 60** (default)

3

Set1 Digit Set2 Max/Min Output Alarms OK

Press briefly to toggle

Press DOWN or UP button briefly and repeatedly to choose from **dY. 10** or **dY. 20** or **dY. 30** or **dY. 60** (4 digits) or **dLAY. 10** or **dLAY. 20** or **dLAY. 30** or **dLAY. 60** (6 digits)

4

Set1 Digit Set2 Max/Min Output Reset Alarms OK

Press to accept

Done!

Reverse Display Function (Mirror Image)

If you need to be able to see a reflection of the display in a mirror or other reflective surface, for example in a simple heads-up system, or for drivers reversing into a bay, using mirrors only, you can set the display to show as a mirror image.

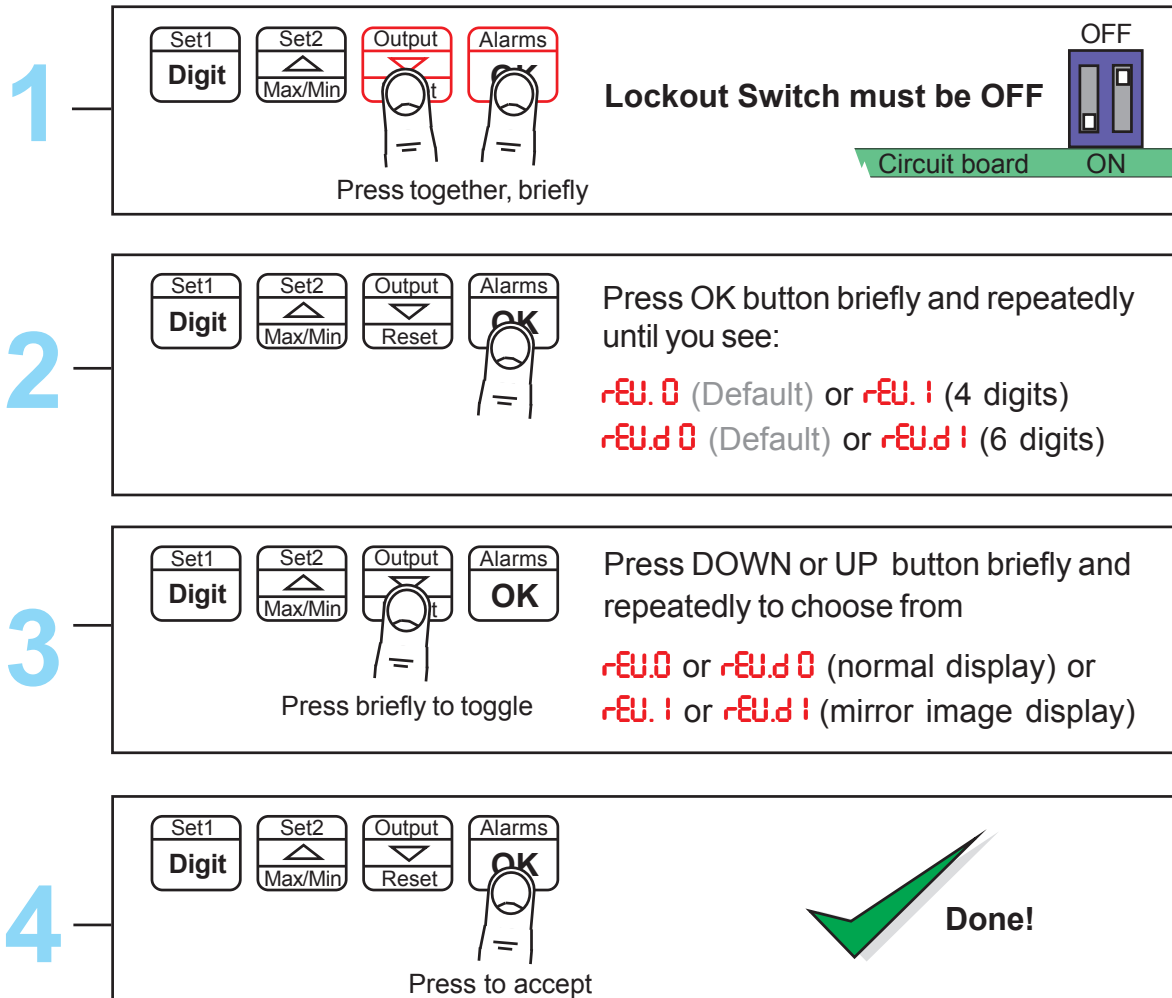

rEU.d 0



Example of normal display format displaying the number 876543

rEU.d !



Example of Mirror Reverse display format displaying the number 876543

Bootup Routine and Tare Save Choices

When you switch on your meter, it can be set to power up with 3 possible summary message combinations. The choices are:-

bt 0 (4 digits) or **boot 0** (6 digits) = Segment test, followed by a full summary of software revision, calibration audit number, model number, installed options.

bt 1 (4 digits) or **boot 1** (6 digits) = Segment test followed by model number (Default)

bt 2 (4 digits) or **boot 2** (6 digits) = No summary, meter displays the measurement value immediately when power is applied.

bt 3 (4 digits) or **boot 3** (6 digits) = All segments illuminate permanently, until a button is pressed.

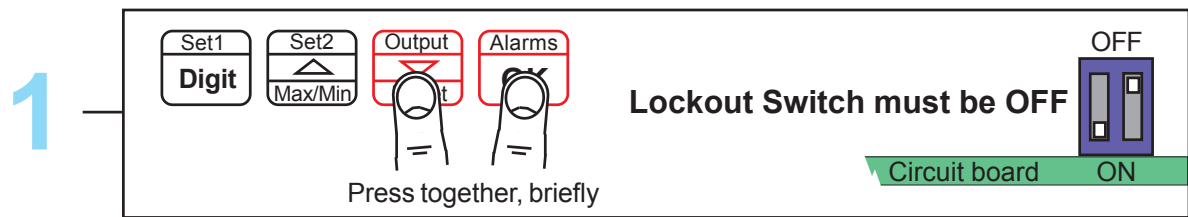
- 

1 — Lockout Switch must be OFF

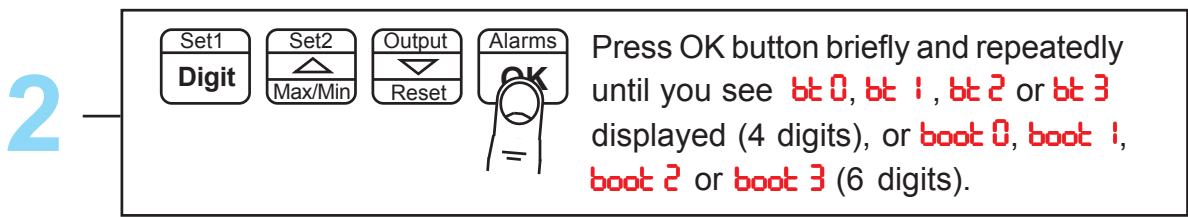
Press together, briefly
- 

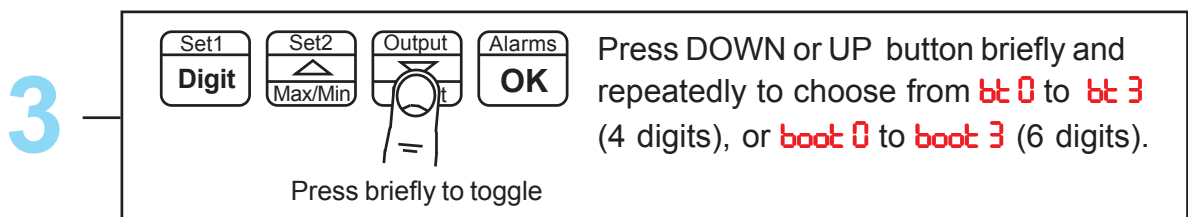
2 — Press OK button briefly and repeatedly until you see **bt 0**, **bt 1**, **bt 2** or **bt 3** displayed (4 digits), or **boot 0**, **boot 1**, **boot 2** or **boot 3** (6 digits).
- 

3 — Press DOWN or UP button briefly and repeatedly to choose from **bt 0** to **bt 3** (4 digits), or **boot 0** to **boot 3** (6 digits).

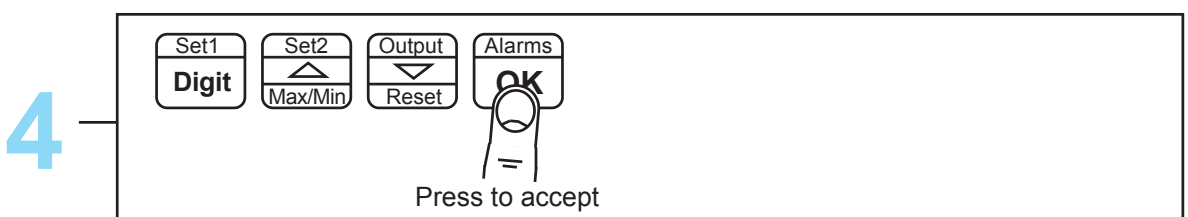
Press briefly to toggle
- 

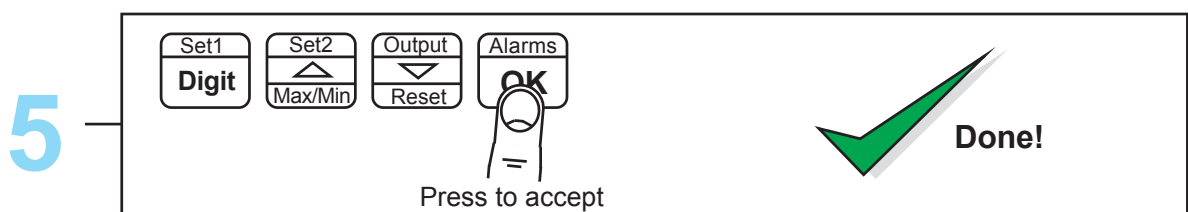
4 — Press to accept
- 

5 — Press to accept

Done!



You can trigger the full summary message whenever you want, without having to power the meter off, by pressing and holding the 2 outer buttons (Set1 + Alarms) for more than 3 seconds.

Language Selection for User Interface

You can select English or French menu prompts.

1

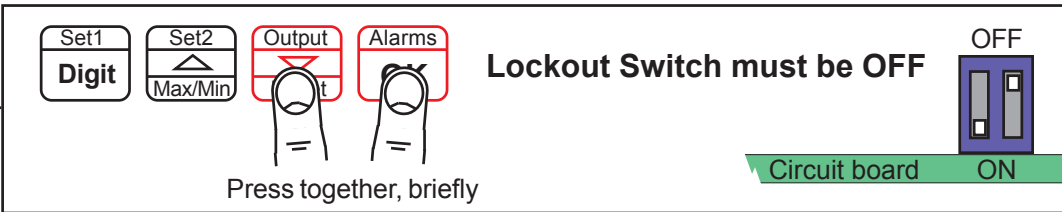

Set1 Digit Set2 Max/Min Output Alarms

Lockout Switch must be OFF

OFF

Circuit board ON

Press together, briefly

2

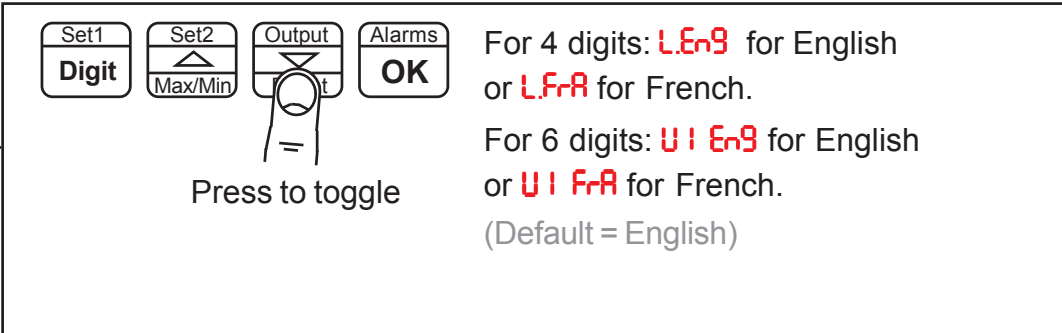

Set1 Digit Set2 Max/Min Output Alarms OK

Press to toggle

For 4 digits: **L E n 9** for English
or **L F r A** for French.

For 6 digits: **U I E n 9** for English
or **U I F r A** for French.
(Default = English)

3

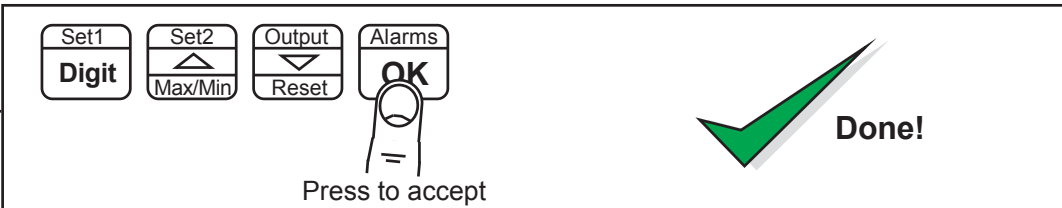

Set1 Digit Set2 Max/Min Output Reset Alarms OK

Press to accept

Done!

Multi-Program Memory -MEM (Rate Mode Only)

The three contact closure inputs on the rear of the meter may be used to call up between 1 to 7 additional meter setup memories (pages), if the MEM option has been installed. This allows you to save up to 8 complete sets of independent calibrations, alarm settings, analogue output settings and serial comms settings.

First decide how many memory pages you want, as this will determine how many logic inputs you will need to use for the addressing. Logic inputs not required for Page Addressing can be used for other functions such as Tare, Reset, Display Hold, Peak/Valley display.

If you have used all 3 logic inputs for Page Addressing, you can still use the meter's front panel buttons to perform Tare, Reset and peak/Valley view.

See "Contact Closure Input Functions" page for CC.1, CC.2, CC.3 and COP settings

Total number of pages	Logic Inputs required for addressing
1	none, standard single page meter
2	1 Set CC.1 = PA.1
3 or 4	2 Set CC.1 = PA.1, Set CC.2 = PA.2
5 to 8	3 Set CC.1 = PA.1, Set CC.2 = PA.2, Set CC.3 = PA.4

1. Set lockout switches OFF, and set page address to 0 or unplug the logic connector.
2. Set the copy instruction to COP.1 in page address 0 (found after you set CC3).
3. Press all 4 buttons together, display shows DEF.n (4 digits) or DEF5.n (6 digits).
4. Press the Up arrow to change display to DEF.y (4 digits) or DEF5.y (6 digits), and press OK.
5. If you want all channels to share a common setting, eg calibration, do that setting now.
6. When you want to do separate settings for each channel, set COP.0

Programming and recalling individual pages

Plug the logic input connector back in, if you removed it earlier. Select a page address using the switch combinations shown below, wired to the Logic Input connector ...

Page address 0	All logic inputs open
Page address 1	CC.1 closed to Common
Page address 2	CC.2 closed to Common
Page address 3	CC.1 and CC.2 closed to Common
Page address 4	CC.4 closed to Common
Page address 5	CC.1 and CC.3 closed to Common
Page address 6	CC.2 and CC.3 closed to Common
Page address 7	All logic inputs closed to Common

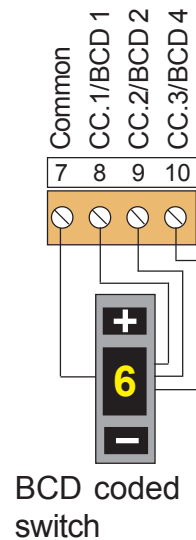

Perform the settings you require, according to the pages in this manual. Do this for all page addresses required. Then put the lockout switch in its ON position. Now, if you select a page address, the meter will briefly confirm the chosen page address on screen, and will then function according to the settings you programmed for that address.

Suitable BCD coded switches are available from many electrical supply stores.

For example consider Kraus & Naimer part A540-600 E24 or Apem part number IRBC10N1248 or London Electronics part number SW2P-8W-BCD, which also provides separate 2-pole, 8-way signal selection function.

Error Codes and Fault Finding



1. Under Range. The meter is being asked to display a value which is more negative than its limit of -199999



2. Over Range. The meter is being asked to display a value which is higher than its limit of 999999

These fault codes could be displayed because the signal scale factor has been set too large or because the input frequency is too high.

3. Display is reading much higher than you expect and may also be erratic. This could be caused by contact bounce if you are using a contact closure input - be sure that the contact debounce is enabled **dbnc.on**

4. Total is not saved on power-down in a DC powered totalizer. This could be caused by converting a DC powered INT2-P, INT2-L, INT2-S etc to an INT2-C. If you have converted one of these models to INT2-C, simply by changing the input board, you will find that total is not stored at power-down. You will need to fit a power-down control module, part number 9122-0401 to the display control board.

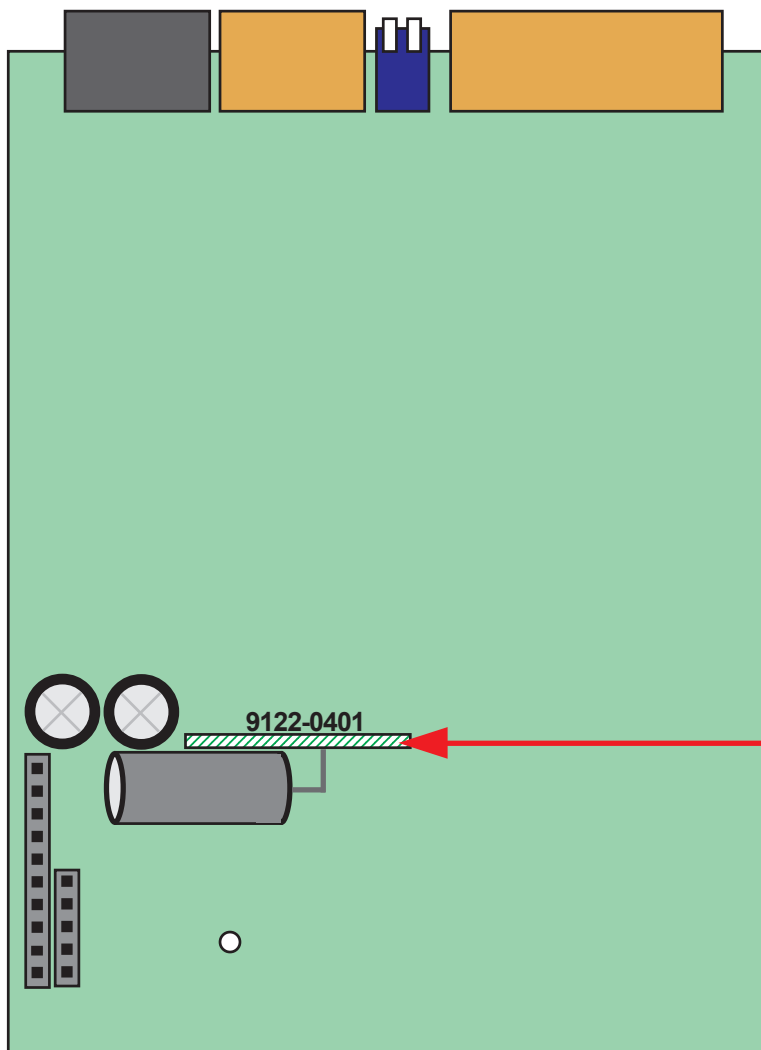

Location of the 9122-0401 board which fits in a slot in the main board.

How to Install Option Boards

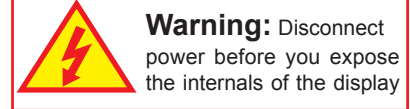
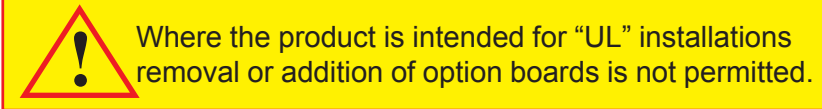

If you want to open your display to install or modify option boards, follow these steps...

- 1) Switch off power to the display and unplug all connectors.
- 2) Undo all the thumb screws on the rear case, store them safely and remove the back panel
- 3) Locate the main option board, which will be similar in appearance to the diagram below. If a main option board is absent, which will be the case if the display was ordered without any output options, then a main option board will need to be fitted.

The board assemblies will look like this:

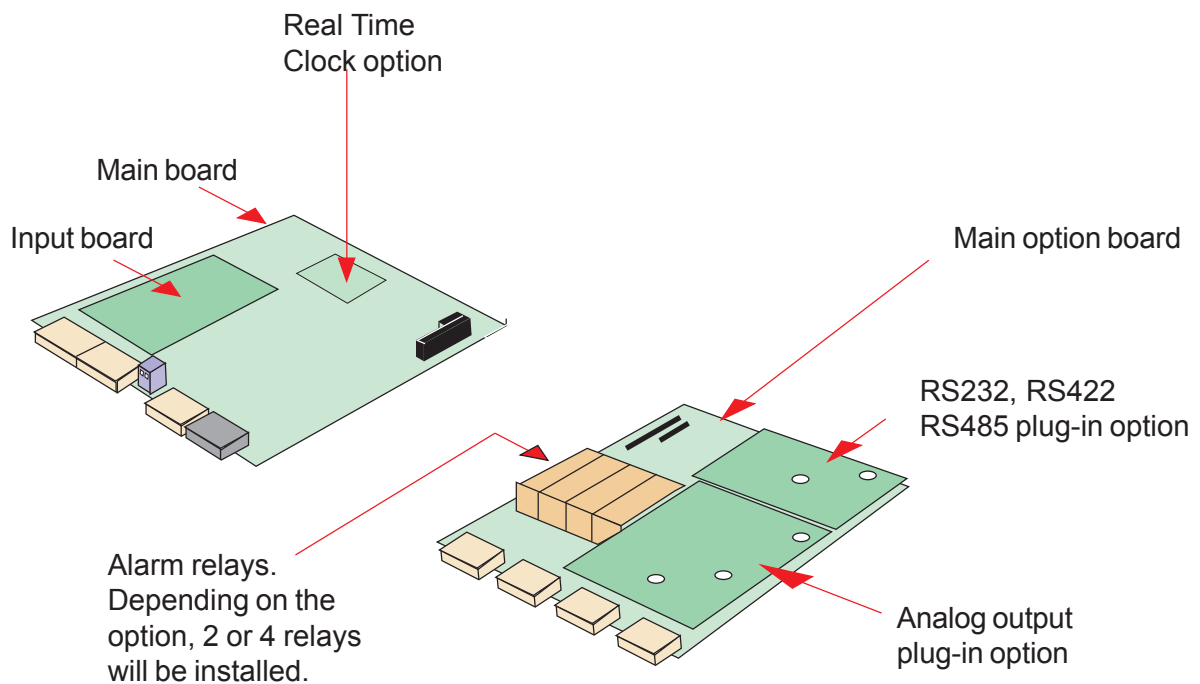

The analog output and RS232 or RS422 plug-in option boards are fixed to the main option board with white plastic pillars. You must apply a firm force when fitting or removing these options.

Always be careful to connect the pins to sockets accurately. When reassembling, make sure option boards are firmly fixed to the upper option board.

Waste Electrical Electronic Equipment (WEEE)

In Europe, this equipment must be disposed of in accordance with European Parliamentary Directive 2002/96/EC

This directive encourages recycling and the reduction of waste materials in the environment.

This means it must be sent to an approved recycling plant if you want to dispose of it.

It must not be thrown away with general rubbish.



WEEE Waste Recycling

If you are unable to dispose of this item locally, you may send it to us for recycling.

Conditions:

1. We will only accept items of our manufacture.
2. You must pay for the transport of the goods to us.
3. We will only accept items if they include a signed declaration by an authorised person in your organisation, stating that :-
 - i. The item is safe to handle and has no contaminants which may be harmful to health.
 - ii. You wish us to dispose of or destroy the item(s)

Equipment Specifications

Case Material	Heavy duty welded uPVC
Connectors	Internal detachable Screw Terminal connectors accessed via compression glands
Environmental	Storage Temperature range -20 to +70°C, non condensing. Operating temperature range 0 to 50°C. Internal heater option available for use in conditions down to -25°C.
Power	100-240 VAC, 45 to 60Hz, 11-30 VDC optional, 48V AC optional
Burden	40VA maximum
Sealing	IP65 (NEMA-4) all round, provided the display is mounted vertically and that all cable glands and rear case-closure screws are properly secured.
Input Signals (4x)	Contact closures, with debounce NPN and PNP proximity sensors (47kilohm pullup/down). 24V logic pulses from PLCs. AC tachometer inputs. 100mV passive Inductance pickup (on Input 1 only).
Frequency Range	0-40 kHz in total mode, 0-100 kHz in Rate mode. 9.5 kHz for quadrature, absolute limit (38,000 edges/sec)
Accuracy (rate/frequency)	+/- 0.05% of range, quartz crystal reference +/- 20 ppm/Degree Celsius temperature coefficient Allow 30 minutes after switch-on, for thermal stabilisation.
Excitation voltage	24VDC nominal rated at 60 mA, to power sensors (standard). 10V DC at 120 mA Max (optional). 5V DC at 30 mA max (optional).
Averaging / smoothing	Selectable averaging time constant of 0 to 25 seconds. Production rate monitoring is adjustable and can be averaged over a full day.
Memory	Totals and settings saved in 10 year non-volatile memory.
Display update rate	3 readings per second in rate mode for signals above 3Hz, otherwise update is as input signal pulse rate. 10 readings per second in totalize modes.
Display Range (max)	-199999 to 999999 for 6 digit versions or -1999 to 9999 for 4 digit versions

Plug-In Output Options

Analog Output

Alarm Relay Output

ASCII Data Output

Calendar/Clock Option

See manuals on our website, or see manual supplied with option.

Record of Revisions

6 September 2010	Version F0.18 Software released. Manual format revised to improve clarity and segregate easy from advanced menu functions. Optional outputs now described in their own dedicated manuals. Cabling guidance added.
1 February 2011	Version F00.21 software released. 100mS display update in totaliser mode. Ability to select rising or falling edge for counting. Boot3 bootup mode added to force display to all segments active.
28 February 2011	Warranty increased to 3 years and terms added.
22 August 2011	Corrected Remote programmer connector details.

Declaration of CE Conformity

Declaration Reference : Fusion
Issue Date : 30 April 2007
Products Covered : Fusion series
Title : DOC-Fusion

This is to confirm that the Product covered by this declaration has been designed and manufactured to meet the limits of the following EMC Standard :

EN61326-1:1997

and has been designed to meet the applicable sections of the following safety standards

EN61010-1:2001



Conditions

The displays are permitted a worst case error of 1% of A/D range during electro-magnetic disturbance, and must recover automatically when disturbance ceases without the need for human intervention, such as resetting, power-down etc.

The displays covered by this certificate must be installed in adherence to the following conditions :-

Signal cabling shall be routed separately to power carrying cabling (includes relay output wiring)

All incoming signal cabling shall be screened. The screen shall only be terminated to the power earth terminal at the meter end of the cable.

Declared as true and correct, for and on behalf of London Electronics Ltd.

J.R.Lees Director