

The logo for CHINO, consisting of the word "CHINO" in a bold, white, sans-serif font, centered within a dark gray rectangular background.

Graphic Recorder

KR2S/KR3S

【Communication Interface】

Instruction Manual

Thank you for purchasing the KR series graphic recorder.

Before using your new recorder, please be sure to read this instruction manual that will advise you on how to use the instrument correctly and safely and how to prevent problems.

— Request to instrumentation engineers, constructors, and sale agents —
Make sure to deliver this instruction manual to the operator of this instrument.

— Request to the operator of this instrument —
This instruction manual is necessary for maintenance, too. Keep this manual with care until the instrument is discarded.

CHINO

Introduction

This manual describes the specifications and operation of three communications interfaces (RS-485 and Ethernet) of the KR2S/KR3S series graphic recorders.

The individual part for each communication is explained separately in [In case of RS-485] and [in case of Ethernet], and the common part is explained all together. Please read the required part carefully. Be sure to confirm the model code of the communications interface of this unit you purchased.

KR2S□P□□□□□□□□

└─ Communication interface (Option)

N: None

E: Ethernet

R: Low/high order communications (RS-485)

G: Ethernet + low/high order communications (RS-485)

KR3S□□ - □□□□ - □□□□

└─ Communication interface (Option)

N: None

E: Ethernet

R: Low/high order communications (RS-485)

G: Ethernet + low/high order communications (RS-485)

◆ Other manuals to be consulted

This manual is for the communications interface only. For the installations of this instrument, please refer to the following separate manuals:

- 1) KR2S / KR3S General Manual (Manual No. INE-861□)
- 2) KR2S / KR3S [Wiring/Installation] Instruction Manual (Manual No. INE-862□)
- 3) SC8-10 Line Converter (Manual No. INE-39)

* For the personal computer (PC) you use, refer to the manual attached to the PC.

Product warranty scope

This product is warranted for one year from the date of delivery. If it is damaged during the warranty period, when used normally based on the cautions in the instruction manual labels attached to the product, etc., it will be repaired without any charge (only in Japan). In the case, we are sorry to trouble you, but please contact your dealer or nearest our sales office.

However, in cases of the followings, it will be repaired at your expense even during warranty period.

1. Failure or damage caused by improper use or connection, or invalid repair or modification.
2. Failure or damage caused by fire, earthquake, wind or flood, thunderbolt, or other extraordinary natural phenomena, or pollution, salt, harmful gas, abnormal voltage, or use of unspecified power.
3. Replacement of parts or accessories that have reached the end of their life.

Furthermore, the term 'warranty' in this sense covers only a CHINO's product itself. Therefore, we are not responsible for compensation for whatever the damage that is triggered by failure of our product.

Important notes for users

1. No part of this manual can be reproduced or copied in any form without permission.
2. The contents of this manual may be altered without prior notice.
3. This manual has been documented by making assurance doubly sure.
However, if any question arises or if any error, an omission, or other deficiencies are found, please contact your nearest CHINO's sales office.
4. CHINO is not responsible for any operation results of this software.

Table of Contents

Introduction	1
Table of Contents	3
1 For safe use	5
1-1 Preconditions for use	5
1-2 Labels on this instrument	5
1-3 Symbols in this manual	5
2 General	6
2-1 RS-485 communications interface	6
2-2 Ethernet	6
3 Communication protocol	7
3-1 MODBUS protocol	7
4 Communications specifications	8
4-1 Serial communications	8
4-2 Ethernet communications	8
4-2-1 Establishment of TCP connection	9
4-2-2 Data transmission and reception through TCP	10
4-2-3 Disconnection of TCP connection	11
4-2-4 Functions at communications failure	11
5 Confirmation of communications specifications and settings	12
5-1 Confirmation of communications specifications	12
5-2 Settings from this unit	12
5-2-1 Settings for Ethernet	12
5-2-2 Settings for High order communications	13
6 Connections	14
6-1 Connection precautions	14
6-1-1 Communications Terminals	14
6-1-2 Total extension of RS-485 communications cable is up to 1.2km.	14
6-1-3 Take measures against noise	14
6-1-4 Crimp type terminals	15
6-1-5 Attach a termination resistor	15
6-1-6 Number of this unit connectable	15
6-2 Communications cables	16
6-2-1 Communications cables for RS-485	16
6-2-2 Communications cables for Ethernet	17
6-3 Communication Line Wiring	18
6-3-1 Connections of High order communication RS-485	18
6-3-2 Connections of low order communication RS-485	19
6-3-3 Ethernet wiring	20
7 MODBUS protocol	21
7-1 Transmission mode of message	22
7-1-1 Transmission data	22
7-1-2 Message frame configuration	22
7-2 Data time interval	23
7-3 Message configuration	23
7-3-1 Slave address	23
7-3-2 Function code	23
7-3-3 Data part	24
7-3-4 Reference number	25
7-3-5 Error check	27
7-3-6 Precautions at the time of data processing	29
7-4 Message creation	30
7-4-1 RTU mode message	30
7-4-2 ASCII mode message	31
7-5 Function Code	32
7-5-1 Reading of digital setting values (Reading of coil status)	32
7-5-2 Reading of digital input data (Reading of input relay status)	33

7-5-3	Reading of analog setting values (Reading of maintenance register contents).....	34
7-5-4	Reading of analog input data (Reading of input register contents)	34
7-5-5	Writing of digital setting values (Changing of single coil status)	35
7-5-6	Writing of analog setting values (Writing of single maintenance resistor)	36
7-5-7	Loop back test	37
7-5-8	Writing multiple analog setting values (Writing to multiple maintenance registers).....	38
7-5-9	Reading of analog setting values (Only KR3S).....	39
7-5-10	Writing multiple analog setting values (Only KR3S).....	39
7-6	Process during abnormality	40
7-6-1	No response	40
7-6-2	Error message response	40
8	Reference table(KR2S:1 to 128CH/KR3S:1 to 128CH).....	42
8-1	Digital setting values	42
8-2	Digital input data.....	43
8-3	Analog input data	49
	8-3-1 Reading of instrument specifications.....	49
	8-3-2 Reading of measured data	50
8-4	Analog setting values.....	57
	8-4-1 Common parameters (Date/time, High order communications, etc.).....	57
	8-4-2 Setting parameters for each channel.....	60
	8-4-3 Communications parameter	70
	8-4-4 Low order communications parameter	90
	8-4-5 Group parameter(KR2S:1 to 5 group/KR3S:1 to 6 group)	103
	8-4-6 Common parameter (screen, schedule, etc.).....	111
	8-4-7 File-related-parameter	115
	8-4-8 Marker text.....	117
	8-4-9 Low order communication setting (PLC relation)	127
	8-4-10 Web server setting.....	129
8-5	Analog setting values(Only KR3S).....	131
	8-5-1 Setting parameters for each channel (from CH50).....	131
	8-5-2 Communications parameter(from CH45)	141
8-6	Range number table	149
9	Setting/displaying on Web screen (Option)	151
9-1	Display and settings using the Web screen	151
	9-1-1 Top page	151
	9-1-2 Recorder display.....	152
	9-1-3 Data display	152
	9-1-4 Input settings.....	153
	9-1-5 Alarm settings	154
	9-1-6 Calculation settings.....	155
	9-1-7 Group settings	156
	9-1-8 Marker text settings	157

1 For safe use

This section “For safe use” has been compiled to promote the correct use of the instrument in order to prevent human injury or damage to property before they occur. If this instrument is used other than description of this document, protection provided by the instrument may be vitiated. Please read the following information carefully and be sure to observe the warnings and cautions in it.

1-1 Preconditions for use



This instrument is a component type general product to be mounted on an indoor instrumentation panel. Do not use this instrument in different situations.

Before using this instrument, ensure the system safety by taking appropriate measures such as fail-safe designing and periodic maintenance for the equipment to which this instrument is installed. Connection, adjustment or operation of this instrument should be performed by a professional engineer with knowledge of instrumentation.

Also, a person who handles this instrument should read this instruction manual to fully understand the cautions and basic operations.

1-2 Labels on this instrument

The following labels are used for safe use.

Label	Name	Meaning
	Alert symbol mark	Indicates the location which should refer to the manual in order to prevent an electric shock and injury.
	Protective conductor terminal	A terminal is provided for connection to the protective conductor of the power supply facility for the prevention of an electric shock.

1-3 Symbols in this manual

The cautions to be observed for preventing the damage of this instrument and unexpected accidents are sorted by the following symbols according to their importance degrees for enabling operators to use this instrument safely.



The nonobservance of information under this symbol may result in hazardous, critical or serious injury to the user.



The nonobservance of information under this symbol may result in a hazardous situation or a light injury to the user or in physical damage to the property.

Remarks	This symbol shows a caution when the instrument dose not function as specified or when such a possibility exists.
---------	---

Reference	This reference servers as a supplement for handling and operation, and it may be convenient for the user.
-----------	---

2 General

The communications interfaces available in this unit are Ethernet and the serial communications RS-485, as option. Via these communications, a PC can receive measured data and set various parameters.

2-1 RS-485 communications interface

The RS-485 communications interface can communicate with multiple KR series graphic recorders (RS-485 up to 31 sets) in parallel by signals conforming to the RS-485.

There are few PCs having the RS-485 communications interface. However, since these communications interfaces are characterized with serial communications, it is easily connectable to a PC having the RS-232C communications interface by using an RS-232C /RS-485 signal-converting unit. A line converter (Model SC8-10) is available for RS-232C/RS-485 signal conversion from CHINO.

2-2 Ethernet

Ethernet is the communications standard specified in IEEE802.3 and is the most widely installed small-sized LAN technology. The KR series graphic recorder is connected to a LAN established by the Ethernet and performs reception of measured data, setting of various parameters, etc.

For the specifications of this unit, connections for the Ethernet, etc., refer to the general manual for this unit.

3 Communication protocol

3-1 MODBUS protocol

The KR series graphic recorder employs MODBUS protocol as the communications protocol.

The MODBUS protocol has RTU mode and ASCII mode that can be selected by keys on the front of this unit or the communications.

By using the MODBUS protocol, operation of measurement, setting, etc. to instruments can be performed.

Ethernet interface performs by implementing the MODBUS protocol on TCP protocol packet.

* MODBUS is a registered trademark of Schneider Automation Inc.

4 Communications specifications

4-1 Serial communications

Specifications of the serial communications of this unit are as follows. * mark shows factory default settings.

Communication system	Half-duplex Start-stop synchronization (polling selecting system)
Protocol	MODBUS protocol
Transmission mode	RTU mode*/ASCII mode
Transmission speed	9600 */19200 bps selectable
Start bit	1 bit
Data length	7 bits/8 bits*(depended on transmission mode)
Parity bit	Non* (none)/Even/Odd(depended on transmission mode)
Stop bit	1 bit*/2 bits(depended on transmission mode)
Transmission code	Binary*(RTU mode)/ASCII(ASCII mode) (depended on transmission mode)
Error check	CRC-16*/LRC (depended on transmission mode)
Data transmission procedure	No procedure
Signals used	Transmission/reception of data only (Control signal not used)
Other	External units precedence communications system

4-2 Ethernet communications

Specifications of the Ethernet communications of this unit are as follows.

Media	Ethernet (10BASE-T/100BASE-TX)
Communications mode	Full-duplex/Half-duplex
Communications speed	10Mbps (10BASE-T)/100Mbps (100BASE-TX) However, as the communications speed and the communications mode are automatically recognized, fixed settings are disabled.
Protocol	MODBUS (RTU) protocol on TCP/IP
Number of simultaneous connection	1 (for high order communications using the MODBUS protocol only)

This unit provides functions of Web, FTP, etc., but this manual describes data communications using MODBUS communications only.

The relation of the MODBUS communications and TCP/IP layers are shown in the table below.

TCP/IP Model Layers	Main protocols used in Ethernet communications
Application layer	MODBUS
Transport layer	TCP
Internet layer	IP, ARP
Physical layer/Data link layer	Hardware (Ethernet)

For details of the MODBUS protocol, refer to **7 MODBUS protocol**.

4-2-1 Establishment of TCP connection

When the high order communications between a PC (the side which requires data: Client) and this unit (the side of which data is required: Server) is performed, it starts from establishing a TCP connection according to the following procedures first.

1. The PC transmits the TCP packet with the SYN flag set to this unit.
2. When this unit receives the SYN packet, it transmits the TCP packet the SYN+ACK flags set to the PC.
3. When the PC receives the SYN+ACK packet, it transmits the TCP packet with the ACK flag set to this unit.

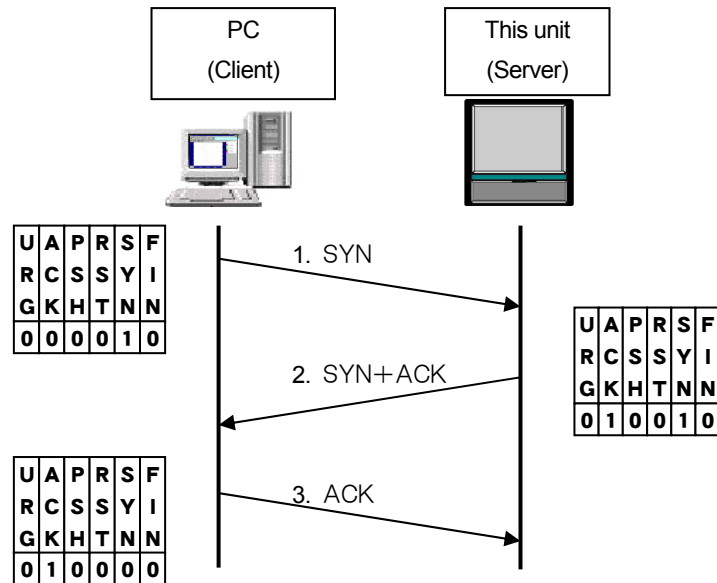

4-2-2 Data transmission and reception through TCP

When the connection is established, transmission and reception of various data through the MODBUS (RTU) protocol on the TCP data between the PC (Client) side and this unit (Server) are performed.

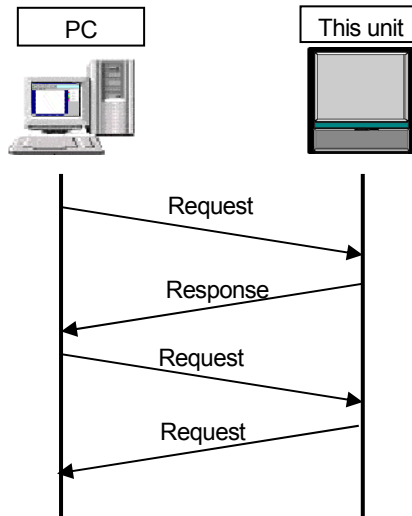
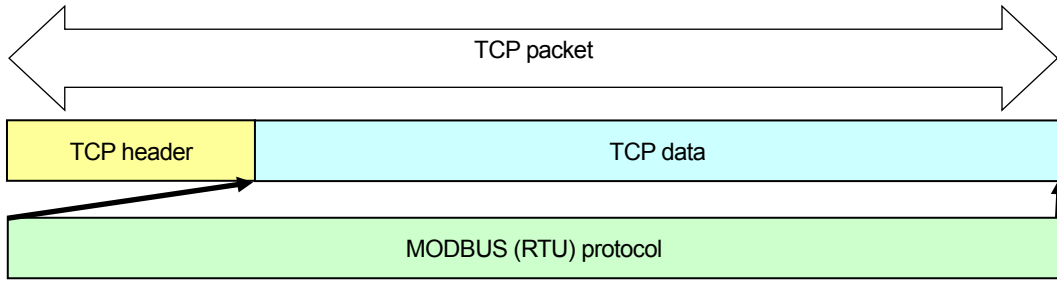

4-2-3 Disconnection of TCP connection

The communication flow at the disconnection of the TCP connection is as follows.

1. The PC transmits the TCP packet with the FIN flag set to this unit.
2. When this unit receives the FIN packet, it transmits the TCP packet the ACK flag set to the PC.
3. This unit transmits the FIN+ACK packet to the PC.
4. The PC transmits the ACK packet responding to the FIN.

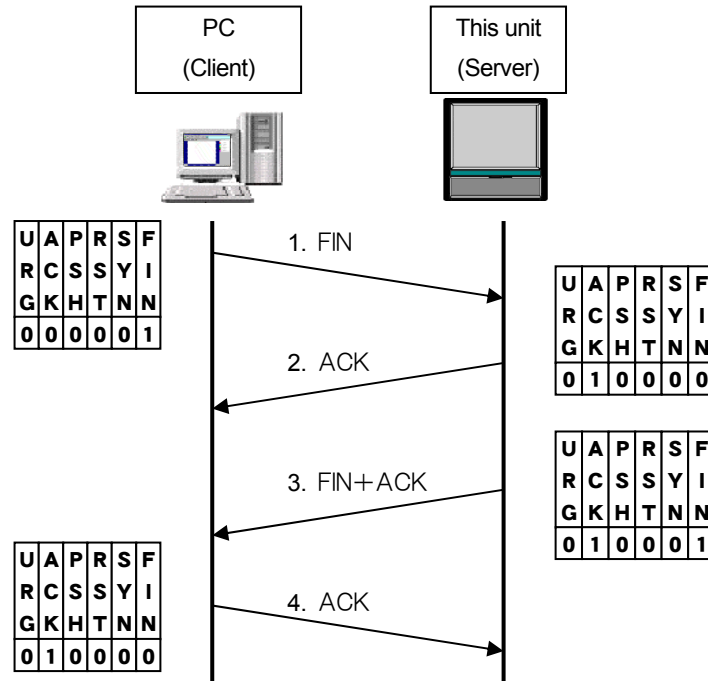

4-2-4 Functions at communications failure

The followings are functions of this unit when the communications failure on the TCP/IP occurs.

- In case that there is no response from a communication partner (PC, etc.)
 When a response (ACK) packet does not return after this unit transmits data to a communication partner on Ethernet, this unit repeats to retry transmission (up to about 3 minutes).
 When there is no response also to the transmission retry packet, this unit disconnects the TCP connection.

 When the communication partner requests to connect the TCP connection to this unit before this unit disconnect the TCP connection, this unit transmits the RST packet to refuse the connection.
- In addition, this unit transmits the RST packet in the following cases.
 - When this unit receives the TCP packet from other than the partner being connected
 - When this unit receives the RST packet from the communication partner
- When this unit receives an unexpected reply packet
 Fundamentally, this unit ignores the unexpected reply packet. However, this unit disconnects the TCP connection as soon as it receives the RST packet in case of forcible disconnection of the TCP connection by the PC side and so on.

5 Confirmation of communications specifications and settings

5-1 Confirmation of communications specifications

When the serial communication is used, confirm the model of this instrument before installations and connections.

KR2S □ □ □ □ □ □ □ □ □ □

Communication interface (Option)

N: None

E: Ethernet

R: Low/high order communications (RS-485)

G: Ethernet + low/high order communications (RS-485)

KR3S □ □ - □ □ □ □ - □ □ □ □

Communication interface (Option)

N: None

E: Ethernet

R: Low/high order communications (RS-485)

G: Ethernet + low/high order communications (RS-485)

5-2 Settings from this unit

5-2-1 Settings for Ethernet

Tap the [Operation] button and then tap [MENU settings] - [Network settings] - [Ethernet settings], the following screen is displayed.

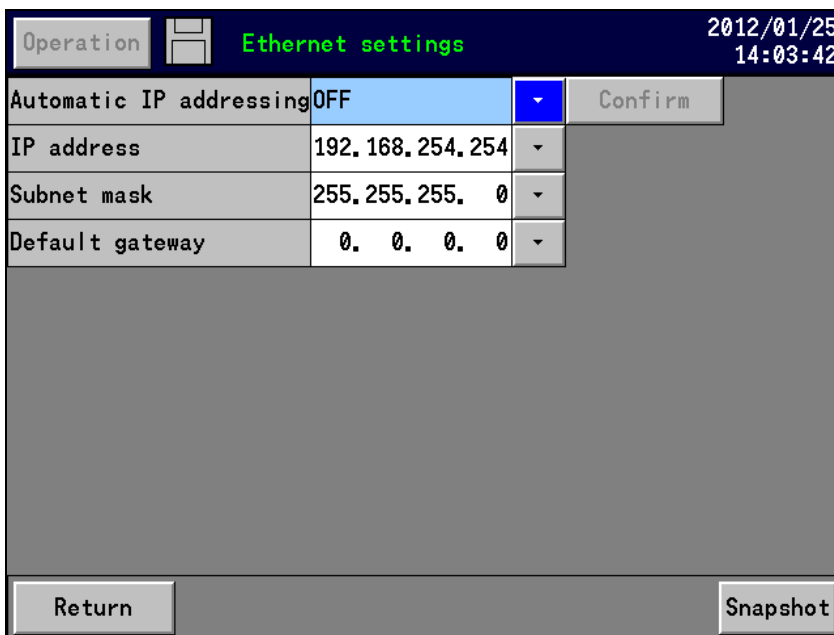

5-2-2 Settings for High order communications

Tap the [Operation] button and then tap [MENU settings] – [System settings] - [High order communication], the following screen is displayed.

TCP/IP	
Port number	11111
Serial communication	
Communication mode	RTU
Instrument address	1
Bit Rate	9,600bps
Communication character	8N1

Port number	Specify the port number used in the high order communications* via Ethernet.
Communications mode	Select the RTU/ASCII.
Instrument address	Set an arbitrary number in the range from 01 to 31.
Bit rate	Select 9600bps or 19200bps.
Communications character	Select it from the codes listed below.

* In case of the high order communications via Ethernet, the communications mode is the RTU and the instrument address is fixed at "01".

Code	Character length	Parity	Stop bit
7E1	7 bits	Even	1
7E2			2
7O1		Odd	1
7O2			2
8N1	8 bits	None	1
8N2			2
8E1		Even	1
8E2			2
8O1		Odd	1
8O2			2

*Codes are used to represent characters. MODBUS RTU mode can set only 8-bit characters(see Section 7-1).

6 Connections

6-1 Connection precautions

6-1-1 Communications Terminals

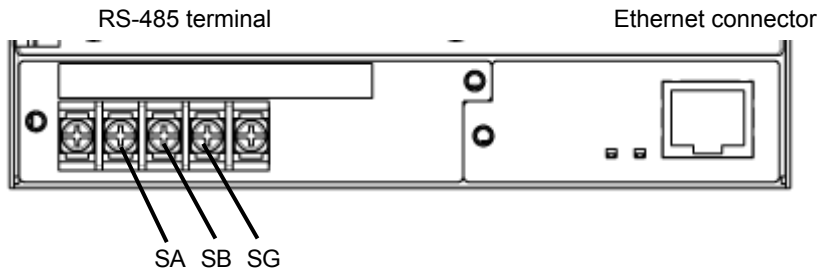

6-1-2 Total extension of RS-485 communications cable is up to 1.2km.

The wiring distance between each instrument is arbitrary, but the total extension length of cable is within 1.2km.

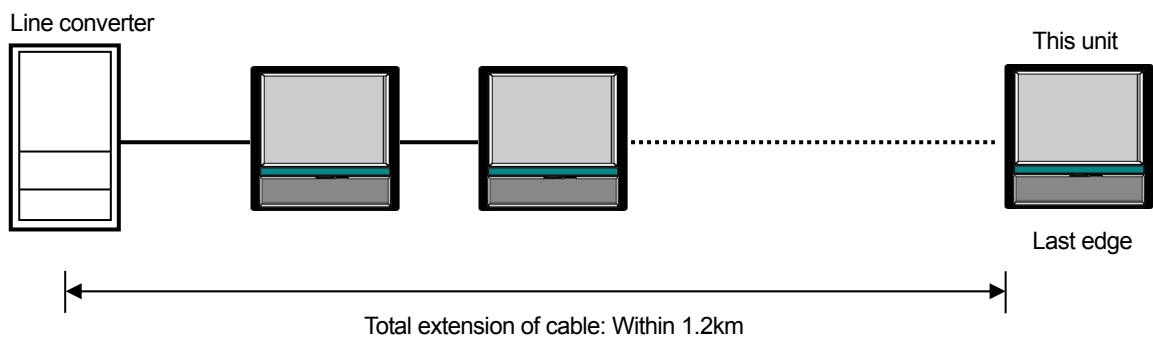

6-1-3 Take measures against noise

Separate the communications cable from power lines and other communications lines more than 50 cm not to be affected by noise.

In addition, when the communications using a PC or an Ethernet hub are performed, depending on circumstances, the hub, communications ICs, or the PC itself may be strongly affected by noise and failures may occur in communication with this unit. In this case, take sufficient measures against noise for the communication lines, the power lines, etc.

6-1-4 Crimp type terminals

Falling off of connections is one of communications failures. Terminate the communications cable with crimp type ring or spade terminals with an insulation sleeve. (The terminal screws of KR2S/KR3S series graphic recorders are M3 and the terminal screws of the line converter are M3.5.)

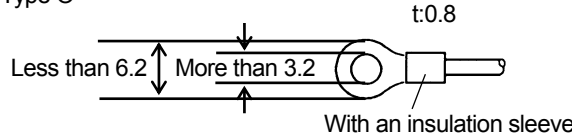
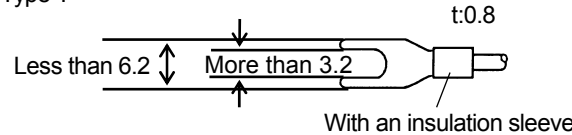
Terminal name	Screw diameter	Tightening torque	Termination (Unit: mm)
Communication terminal	M3	0.5N·m	<p>Type O</p>  <p>Type Y</p>  <p>*Use Type O whenever possible.</p>

6-1-5 Attach a termination resistor

For using the RS-485 communications, mount a 100 Ω resistor to the KR series graphic recorder connected at the final end. (For details, see Section 6-3)

[A general metal film resistor can be used. The resistor (sold separately) is available at CHINO.]

However, there are also environments where a communication error cannot take place easily without the termination resistor attached

6-1-6 Number of this unit connectable

Up to 31 sets



Caution

The distance and the number that can be communicated in the high quality according to the kind of the communications cable used or the connected equipment are different though communication IC in accordance with each communication standard is used about connected the number.

Especially, please note that the number that can be connected becomes ten or less when the equipment using communication IC that conforms only to RS-422A standard is connected with the same communication line as KR.

6-2 Communications cables

Use communications dedicated cables. Communications dedicated cables (sold separately) are available at CHINO.

6-2-1 Communications cables for RS-485

1.Connections between a line converter and the KR series recorder.

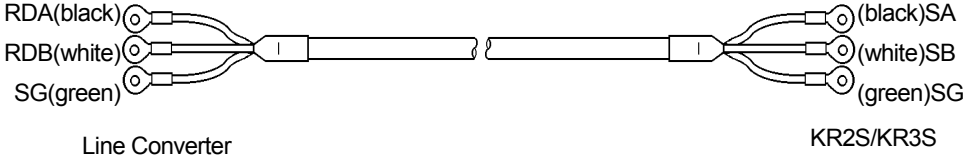
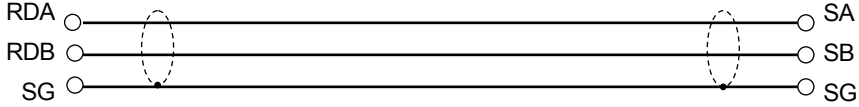
Cable	Crimp type ring terminals ↔ RS-485 with crimp type ring terminals
Shape	 <p>The cable consists of a twisted dual-core with SG (signal grounding) wire at both ends. As the line converter has no SG terminal, cut this wire to use.</p>
Internal wiring	
Type code	<p>RZ-CSS2□□</p> <p>————— Cable length: 1 to 99m (to be specified)</p>

2.Connections between the KR recorder and the KR recorder.

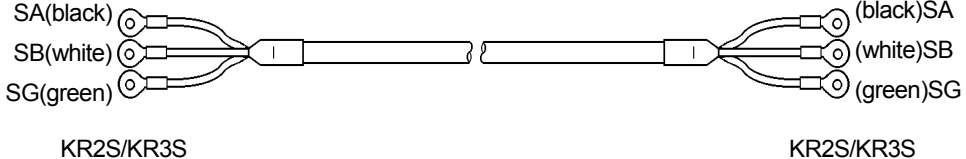
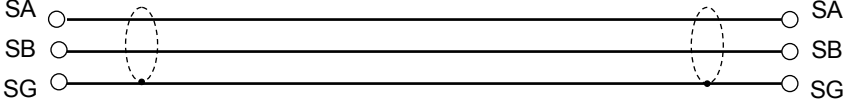
Cable	Crimp type ring terminals ↔ RS-485 with crimp type ring terminals
Shape	 <p>The cable consists of a twisted dual-core with SG (signal grounding) wire at both ends. As the line converter has no SG terminal, cut this wire to use.</p>
Internal wiring	
Type code	<p>RZ-CSS2□□</p> <p>————— Cable length: 1 to 99m (to be specified)</p>

6-2-2 Communications cables for Ethernet

1. Connection between PC and device

When connecting a device to a PC directly (one-to-one), use a shielded, crossover twisted pair cable (commercially available STP cable).

2. Connection between HUB and device(multiple devices can be connected)

When connecting devices to a PC via HUB (one-to-N), use a shielded, straight pair cable (commercially available STP cable).

6-3 Communication Line Wiring

6-3-1 Connections of High order communication RS-485

PC and multiple devices are connected with RS-485. A line converter is required.

RS-485 cables within 1.2km of total extension and up to 31 devices can be connected.

Install a resistor of 100 Ω to the last edge of the transmission line device side.

(General metal film resistors will be fine. They are available from us, place an order.)

Example of terminal connection

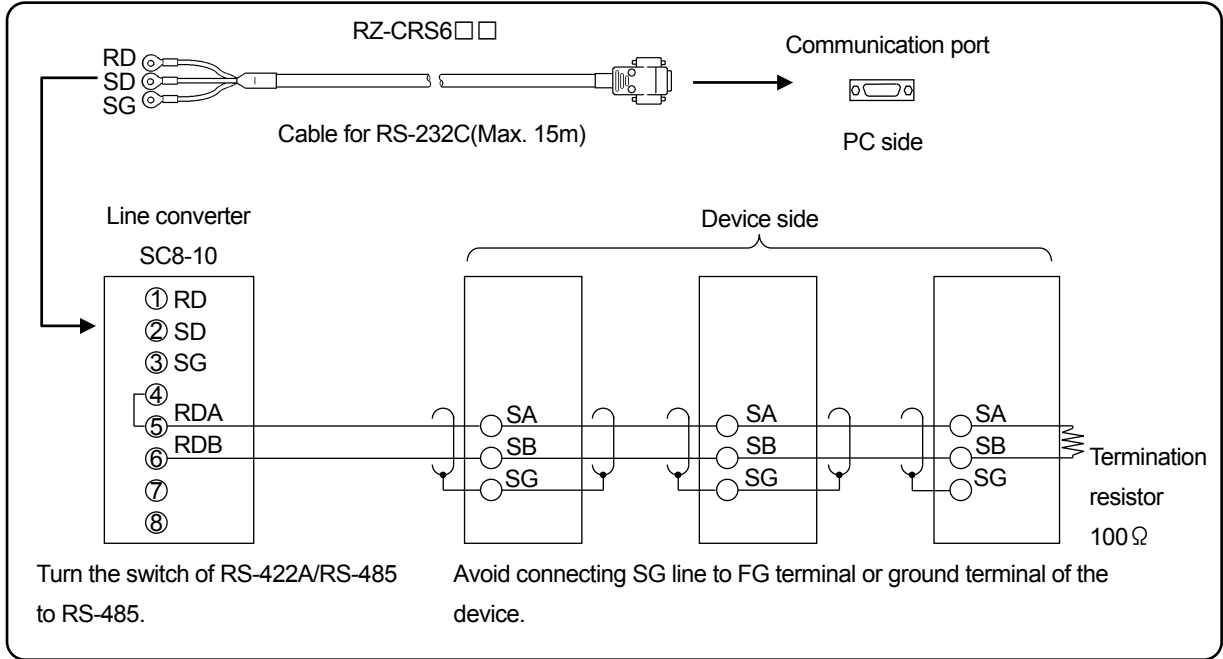

6-3-2 Connections of low order communication RS-485

Connect SA, SB of this recorder and SA, SB of low order connected instrument like the following figure. Refer to instruction manual of each instrument for detail method of low order instrument connection.

Example of terminal connection 1

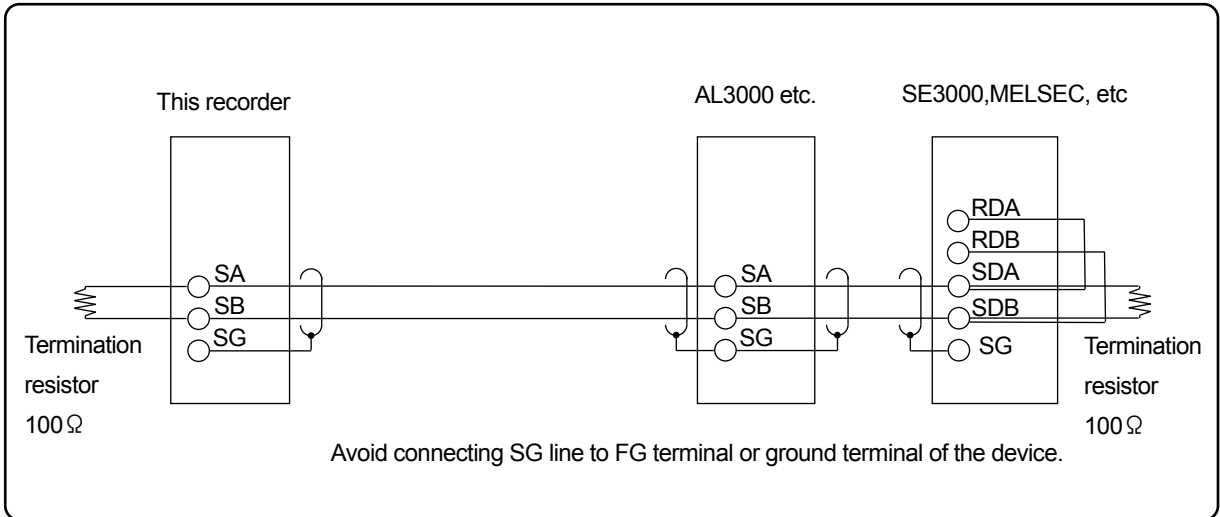

Example of terminal connection 2(SYSMAC)

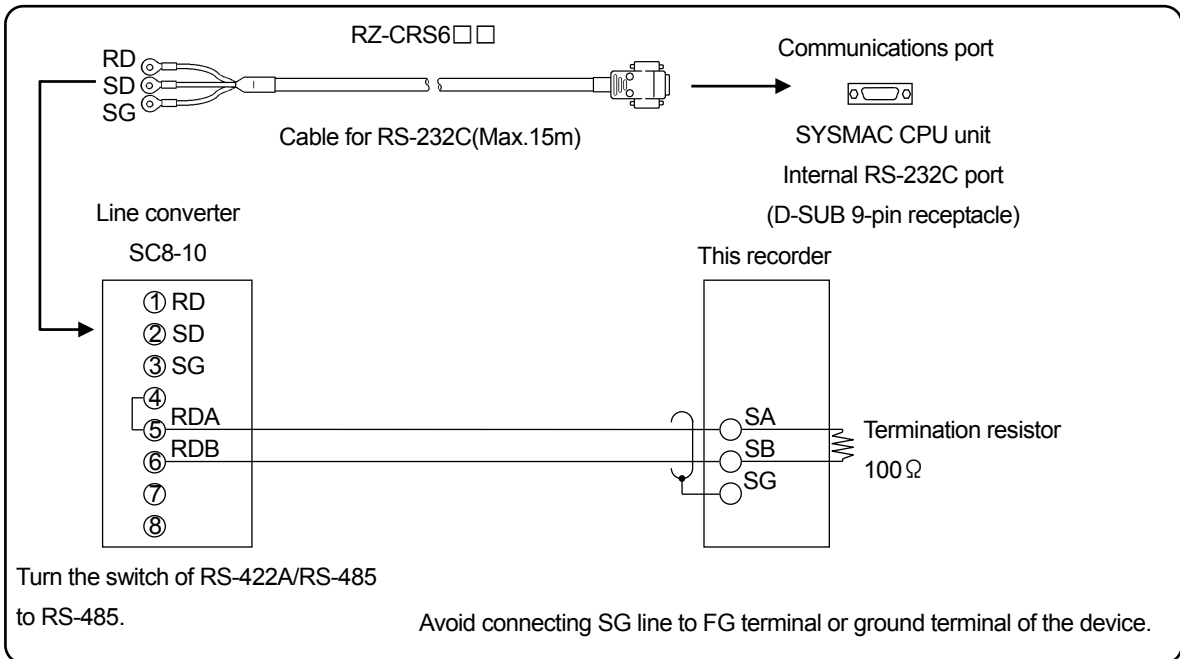

6-3-3 Ethernet wiring

① Example of connection between PC and Ethernet devices(one-to-one connection)

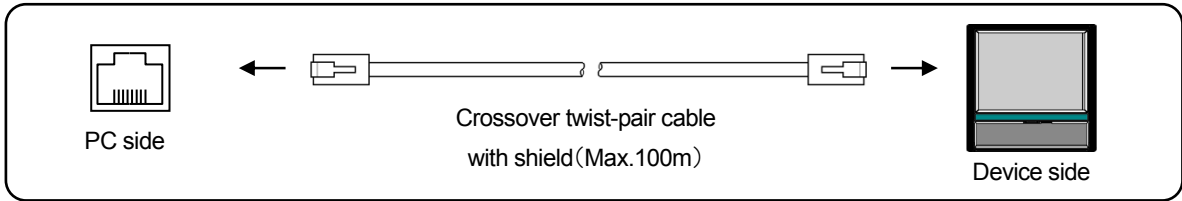

② Example of connection between PC and HUB/Ethernet devices(one-to-N connection)

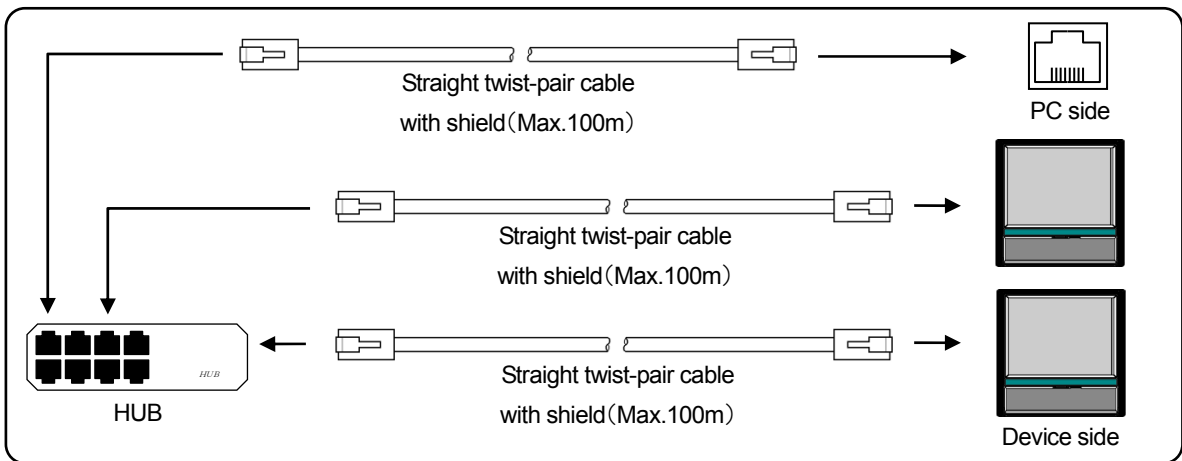

7 MODBUS protocol



Caution

Make sure to read and understand this section to avoid any troubles.

1. Requesting data immediately after power-on generates an error

The unit is always ready for communications and responsive to data request from PC. However, after power-on, the unit does not respond normally until channel data becomes ready.

2. As the control signal wire is not used, pay attention to retransmit a command.

The serial interface of this instrument communicates without using control wire. Pay attention to retransmit a command as reception defects may occur depending on the status of this instrument.

3. Do not remove any devices or communication cables and do not turn ON or OFF the power supply during communications.

If devices or cables configuring the serial interface are removed or if the power is turned ON (OFF) during communications, the communications may stop or an error may occur. If this happens, reset all the devices configuring the serial interface and restart the communications from the beginning.

4. Transmit the next command after confirming that the communication drive is switched OFF.

In RS-485, if multiple instruments are connected to same communications line, then only 1 instrument, of which instrument number is specified from the PC, drives the communications line. At that time, for transmitting all the characters to the PC completely, the drive of the communications line is turned OFF with some time interval after the last character is sent. If the PC transmits a command to the next instrument before it becomes OFF, then the signal crashes and normal communications cannot be done. Therefore take care when a high speed PC is used. This interval is around 5ms.

7-1 Transmission mode of message

There are 2 types of the RTU (Remote Terminal Unit) mode and the ASCII mode.

(Table 1. Comparison of RTU mode and ASCII mode)

Item		RTU mode	ASCII mode
Transmission code		Binary	ASCII
Error detection (Error check)	Vertical direction	Parity	
	Horizontal direction	CRC-16	LRC
Character configuration	Start bit	1 bit	
	Data bit	8 bits	7 bits, 8 bits
	Parity bit	None, odd, even	None*, odd, even
	Stop bit	1bit/2 bits	
Message start code		None	: (Colon)
Message end code		None	CR, LF
Data time interval		Less than 28-bit hours	Less than 1 second

* When the data bit is 7 bits, [Parity bit None] is not applicable.

7-1-1 Transmission data

The RTU mode is binary transmission.

The ASCII mode divides 8 bits binary of the RTU into higher 4 bits and lower 4 bits and converts into characters respectively (0-9, A-F).

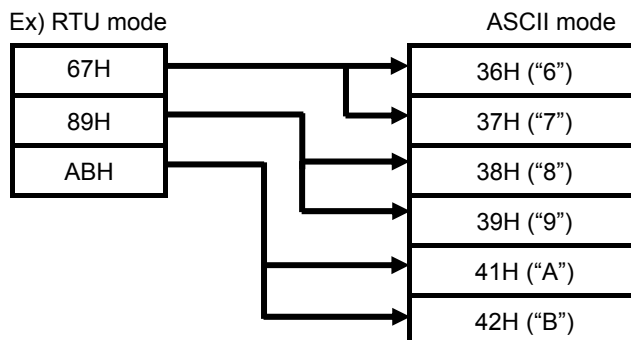

The RTU mode is half in the message length as compared to the ASCII mode and enables the efficient transmission.

7-1-2 Message frame configuration

The RTU mode is configured by message parts only.

The ASCII mode is configured by the start character “: (colon, 3AH)”, messages and the end character “CR (carriage return, 0DH) + LF (Line feed, 0AH)”.

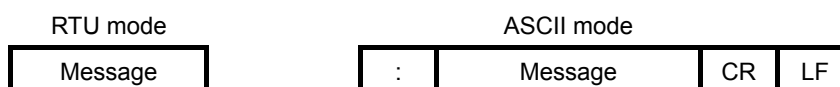

As the ASCII mode has the start character of “:” it has an advantage that the troubleshooting is easy.

7-2 Data time interval

RTU mode: Less than 28-bit hours (2.8msec at 9600bps, 1.4msec at 19200bps)

ASCII mode: Less than 1 second

When a message is sent, be careful that the time interval of data configuring one message does not exceed the time shown above. If the time interval exceeds the time shown above, the receiving side (this unit) judges that the transmission from a sender is finished and the data are processed as the reception of an abnormal message.

In the RTU mode, message characters should be sent continuously, but in the ASCII mode, as the interval between the characters is maximum 1 second, a master (PC) whose processing speed is comparatively slow can be used.

7-3 Message configuration

The MODBUS messages have the following configuration for both of the RTU mode and the ASCII mode.

Slave address
Function code
Data
Error check

7-3-1 Slave address

Slave addresses should be set in advance in a range of 1-31. The master usually communicates with 1 slave. Only the slave corresponding with the slave address in the command message from the master responds to that message.

The slave address "0" is used in messages (Broadcast) to all the slaves from the master. In this case, the slaves do not return any response.

7-3-2 Function code

The function codes are the codes to be performed in the slaves and each data is roughly categorized as follows. The table shows original functions of MODBUS and functions of our MODBUS instruments.

(Table 2. Function codes)

Code	Function	Unit	MODBUS original function (Reference)
01	Reading of digital (ON/OFF) setting value	1 bit	Reading the status of coil
02	Reading of digital input data	1 bit	Reading the status of input relay
03	Reading of analog setting value	16 bits	Reading the content of holding register
04	Reading of analog input data	16 bits	Reading the content of input register
05	Writing digital setting value	1 bit	Changing the status of single coil
06	Writing analog setting value	16 bits	Writing to single holding register
08	Transmission of received data (for diagnosis)		Loop back test
16	Writing multiple analog setting values		Writing to multiple holding registers
60	Reading of analog setting value (from CH50)	16 bits	Reading the content of holding register
61	Writing multiple analog setting values (from CH50)		Writing to multiple holding registers

1. **Digital settings value** Parameters to change functions including record ON/OFF, marker text record, etc.
2. **Digital input data** Data of event activation status, etc.
3. **Analog settings value** Various setting information.
Numeric values are in the range of 16 bits (-32763 to 32767).
4. **Analog input data** Measurement data, instrument specification information, etc.
Numeric values in the range of 16 bits are outputted.

7-3-3 Data part

Data structures differ depending on the function codes. In case of requests from the master, they are configured by a code number (relative numbers calculated from reference numbers mentioned hereafter) of the target data for reading/writing and number of data, etc. Responses from the slaves are configured by data requested by a command etc.

All basic data of MODBUS are 16-bit integers and existence of a mark is decided for each data.

Therefore real values of data like measured values are expressed by allocating a decimal place to a different address or by normalizing with high/low values of a scale while the decimal place is fixed. This instrument adopts the allocation method of the decimal place to a different address.



In the data part, there are specific numeric values such as input data allocated as error data. When using such data, perform the error judgment of data first and then combine them with decimal point data.

If such error data are combined with decimal point data first, they are judged as normal data.

7-3-4 Reference number

Numbers called “Reference numbers” are allocated to all the data of this instrument and these numbers are necessary for reading/writing data.

The data are classified into “Digital setting values”, “Digital input data”, “Analog input data” and “Analog setting values” depending on their types. Number designation in messages is performed by relative numbers corresponding to the respective reference numbers.

(Table 3. Reference numbers and relative numbers)

Data type	Reference number	Relative number	MODBUS original (Reference)
Digital setting value	1 to 10000	Reference number - 1	Coil
Digital input data	10001 to 20000	Reference number - 10001	Input relay
Analog input data	30001 to 40000	Reference number - 30001	Input register
Analog setting value	40001 to 50000	Reference number - 40001	Hold register
Analog setting value	50001 to 60000	Reference number - 50001	

For example, the relative number of “Reference number 30101 (Data of Channel 1)” mentioned later becomes “100”.

(Table 4. Reference numbers)

Data type	Parameter	Reference number	Corresponding function code	Reference table
Digital setting value	Key lock Record ON/OFF Marker text writing	1 to 20	01 (READ) 05 (WRITE)	Para. 8-1
Digital input data	Event status	10101 to 10800	02 (READ)	Para. 8-2
Analog input data	Instrument information Measurement data	30001 to 30094 30101 to 30188	04 (READ)	Para. 8-3
Analog setting value	Common parameter (Date/time, High order communications, processing reset, etc.)	40001 to 40098	03 (READ) 06 (WRITE) 16 (WRITE)	Para. 8-4
	Setting parameter for each channel	40102 to 44500		
	Communications parameter	45001 to 45486		
	Lower communications parameter	45501 to 45544		
	Group parameter	46001 to 46500		
	Common parameter (screen, schedule, etc.)	47110 to 47167		
	File-related-parameter	47207 to 47700		
	Marker text	48001 to 48950		
	Low order communications Setting(PLC)	48951 to 48985		
	Web server setting	49001 to 49064		
Analog setting value (after the CH50)	Setting parameter for each channel	50002 to 57900	60(READ) 61(WRITE)	Para. 8-5
	Communications parameter	58001 to 58082		

7-3-5 Error check

The error check of transmission frame differs depending on the mode.

RTU mode: CRC-16

ASCII mode: LRC

1. Calculation of CRC-16

The CRC method divides the information to be sent by a generating polynomial and transmits it by attaching the calculated remainder to its end. The generating polynomial is as follows.

$$1 + X^2 + X^{15} + X^{16}$$

The following calculation is performed for information from a slave address to the end of data.

- 1) Initialization (=FFFFH) of data of CRC-16 (consider as X)
- 2) Exclusive OR of data 1 and X (EX-OR) → X
- 3) 1-bit shifting of X to the right → X
- 4) For a carry existed, A001H and EX-OR are taken, else go to 5). → X
- 5) 3) and 4) are repeated up to 8-time shifts.
- 6) EX-OR of the following data and X → X
- 7) Same as 3) - 5)
- 8) Repeating up to the last data.
- 9) A message is created in the order from lower digits to higher digits of the calculated 16-bit data (X).

Example)

When data is [02H][07H], the CRC-16 becomes 1241H.

Then the error check data becomes [41H][12H].

Reference: CRC-16 calculation program (C language)

```

/***** CRC-16 calculation program *****/
#include <stdio.h>
#include <conio.h>

void main(void){
    /*** Internal variable declaration ***/
    unsigned    int        iLoopCnt;           /* Loop counter*/
    unsigned    short      usData;            /* Input data*/
    unsigned    short      usCrcData;         /* CRC-16 data*/
    unsigned    short      usErrChkData;     /* Error check data*/
    int         iDummy;                      /* Dummy variable*/

    /* (1) Initialization of output result of a CRC-16 data */
    usCrcData = 0xffff;

    printf("Enter the hexadecimal data (Cancel by [q].) >\n");
    while( scanf("%x", &usData) != 0){
        /* (2) (6) Taking exclusive OR of the CRC output result and the entered data */
        usCrcData = usData ^ usCrcData;

        /*** CRC calculation processing ***/
        /* (5) Repetition up to 8-bit shifts */
        for(iLoopCnt = 0 ; iLoopCnt < 8 ; iLoopCnt++){
            /* (4) Checking if there is a carry. */
            if(usCrcData & 0x0001){
                /* (4) At a carry activated */
                /* (3) 1-bit shifting of the CRC output result to the right */
                usCrcData = usCrcData >> 1;

                /* (4) Taking exclusive OR with A001H */
                usCrcData = usCrcData ^ 0xa001;
            }else{
                /* (4) At a carry no activated */
                /* (3) 1-bit shifting of the CRC output result to the right */
                usCrcData = usCrcData >> 1;
            }
        } /* for */
    }; /* while */

    printf("The CRC-16 data is %xH.", usCrcData);

    /* Error check data creation*/
    usErrChkData = (usCrcData >> 8) | (usCrcData << 8);
    printf("The data for the error check is %xH.", usErrChkData);

    iDummy = getch();
}

```

2. LRC calculation method

The data from a slave address up to the end of the data are calculated by the following procedure.

- 1) A message is created in the RTU mode.
- 2) The data from the start (slave address) to the end are added. $\rightarrow X$
- 3) The complement (Bit inversion) of X is taken. $\rightarrow X$
- 4) 1 is added. $(X=X+1)$
- 5) X is attached at the end of the message as the LRC.
- 6) The entire data is converted into the ASCII character.

Example) When the data is [02H][07H] , the LRC becomes F7H. Therefore the binary message becomes [02H][07H][F7H] and the ASCII message becomes [30H][32H][30H][37H][46H][37H].

7-3-6 Precautions at the time of data processing

- 1) As the measurement data and the decimal place are assigned to different numbers, it is necessary to use both information at replaying the data.
- 2) As each 1 data can be accessed (changed), precautions are necessary at the time of setting the associated data including Initialization process of the associated data due to change of a range number, etc.
- 3) Read and write the data in the range stipulated by the reference number. Reading and writing of reference number not stipulated may have an adverse effect on the instrument operation.
- 4) At the reading of continuous reference numbers, the data of the reference number not stipulated becomes "0".
- 5) At the writing to continuous reference numbers, if error is detected, all the settings become disabled.

7-4 Message creation

A message is consisted of 1) Slave address, 2) Function code, 3) Data part and 4) Error check code.
(Refer to Para. 7-3)

The number of data that can be read once is within the following range.

Transmission mode	Number of data
RTU	120
ASCII	120

The creating method of a message is explained in the following example.

Example) Reading of the measurement data of “Channel 1” of this unit set by the “Slave address 02”.

7-4-1 RTU mode message

1) Slave address: 02 ([02H])

2) Function code: 04 ([04H])

It is the reading of the analog input data (contents of input register). When the function code is “04”, it is necessary to specify “Relative number of data 2 bytes” for reading in the data part and “Number of data 2 byte” for reading. (Refer to Para. 7-5 Refer to Para. 7-5-4 for “Function code: 04”.)

* It is necessary to confirm the number of bytes of data.

3) Data part: Starting relative number 100 ([00H][64H]) , Number of data 2 ([00H][02H])

The measured data (analog input data) is stored in the reference number 30001 to 40000.

(Refer to Para. 7-3-4 Table 3). By the reference table, you will understand that the integer part of CH1 is stored in “30101” and the decimal place is stored in “30102”. (Refer to Para. 7-5 and refer to Para. 7-5-3 for reading of measured data.) The relative number of the starting “Reference number 30101” is 30101-30001=100. If it is expressed in 2 bytes, it becomes “[00H][64H] “. The number of data to be read is the integer part of CH 1 and the decimal place and if it is expressed in the hexadecimal 2 bytes, it becomes “[00H][02H] “.

4) Error check: Calculation by the CRC-16 2730H ([30H][27H])

The error check in RTU mode is performed by the CRC-16. (Refer to Para. 7-3-5) The data of basic part of the message becomes [02H][04H][00H][64H][00H][02H] as per 1) to 3), and the CRC-16 becomes 2730H. Therefore the error check data becomes [30H][27H].

5) Message: A message is created with the configuration of [02H][04H][00H][64H][00H][02H][30H][27H].(Refer to 7-3)

7-4-2 ASCII mode message

The error check LRC is calculated from basic part of the message. The LRC becomes 94H. (Refer to 7-3-5). Each data of the basic part is converted into the ASCII code. In addition, the LRC is converted into ASCII code and is attached to the basic part. The start character of the message ":", and "CR" and "LF" are added to the end.

(Example) In case of 02H, 04H, 00H, 64H, 02H, 30H and 27H

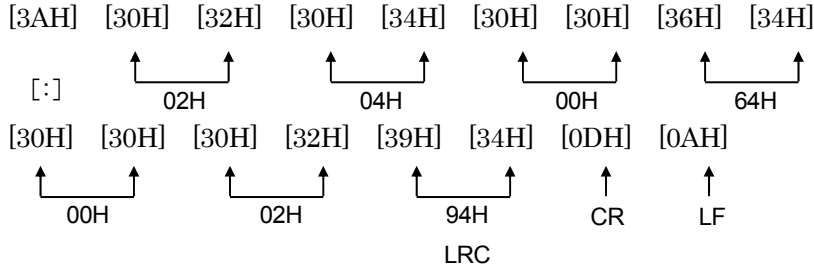

7-5-2 Reading of digital input data (Reading of input relay status)

Function code : 02 [02H]

“Digital (ON/OFF) input data with the continuous numbers” are read for the number of data specified from the start number specified. The ON/OFF data is arranged per 8 by 8 in numerical order in 1 data (1 byte) and configures a data of the response message. The LSB (D0 side) of each data is the digital data of the youngest number. When the number of read data pieces is not in multiples of 8, the unnecessary bits become 0.

The start number (Relative number) is “Reference number - 10001”.

Example) Reading of 4 digital input setting value reference numbers from 10109 to 10112 of the slave 2

Reference number	10109	10110	10111	10112	10113	10114	10115	10116
Data	ON	OFF	ON	OFF	-	-	-	-
	Level 1	Level 2	Level 3	Level 4	“0” is responded as no reference number exists.			
	CH1 Event activation status							

< RTU mode >

Master → Instrument

Slave address	02H
Function code	02H
Start No. (H)	00H
End No. (L)	6CH
Number of data (H)	00H
Number of data (L)	04H
CRC (L)	B9H
CRC (H)	E7H

Instrument → Master(Normal)

Slave address	02H
Function code	02H
Data pieces	01H
First 8 data	05H
CRC (L)	81H
CRC (H)	CFH

First 8 data

0	0	0	0	0	1	0	1
---	---	---	---	---	---	---	---

 (05H)

Reference number 1011210109

“0” is responded as the reference numbers from 10113 to 10116 do not exist.

<ASCII mode error check>

Error check: The CRC (L) and the CRC (H) parts are as follows.

LRC	8CH	LRC	F6H
-----	-----	-----	-----

*The start number (Relative number) is “Reference number - 10001”.

(Decimal 108 (= 10109 - 10001) → Hexadecimal 6CH)

*The data pieces are the number of bytes of data.

(It differs from the number of data requested. In the example, the requested number of data is 4 and the data piece is 1.)

7-5-3 Reading of analog setting values (Reading of maintenance register contents)

Function code : 03 [03H]

“Analog setting values (2 bytes: 16 bits) with the continuous numbers” are read for the number of data specified from the start number specified. The data is arranged by splitting into higher 8 bits and lower 8 bits in numerical order and configures a data of the response message.

Example) Reading of the range high/low limits and the decimal point of Channel 1 of the slave 2
(Reading of 3 analog setting value reference numbers from 40104 to 40106 of the slave 2)

Reference number	40104	40105	40106	
Data	0 (0000H)	1000 (03E8H)	1 (0001H)	← Data example 0.0 to 100.0

<RTU mode>

Master → Instrument		Instrument → Master(Normal)	
Slave address	02H	Slave address	02H
Function code	03H	Function code	03H
Start No. (H)	00H	Data pieces	06H
End No. (L)	67H	Low limit value data (H)	00H
Number of data (H)	00H	Low limit value data (L)	00H
Number of data (L)	03H	High limit value data (H)	03H
CRC (L)	B4H	High limit value data (L)	E8H
CRC (H)	27H	Decimal point data (H)	00H
		Decimal point data (L)	01H
		CRC (L)	74H
		CRC (H)	35H

<ASCII mode error check>

Error check: The CRC (L) and the CRC (H) parts are as follows.

LRC	91H	LRC	09H
-----	-----	-----	-----

*The start number (Relative number) is “Reference number - 40001”.

(Decimal 103 (= 40104 - 40001) → Hexadecimal 67H)

*The data pieces are the number of bytes of data.

(It differs from the number of data requested. In the example, the requested number of data is 3 and the data pieces are 6.)

*There is a limitation on the data pieces for the message (that this unit can transmit) that can be received at a time. (Refer to Para. 7.4)

7-5-4 Reading of analog input data (Reading of input register contents)

Function code : 04 [04H]

“Analog input data (2 bytes: 16 bits) with the continuous numbers” are read for the number of data specified from the start number specified. The data is arranged by splitting into higher 8 bits and lower 8 bits in numerical order and configures a data of the response message. The response example is same as “Function code 03”, but the start number (Relative number) is “Reference number - 30001”.

7-5-5 Writing of digital setting values (Changing of single coil status)

Function code : 05 [05H]

The digital setting value specified is put into the status (ON/OFF) specified.

Example) Execution of the marker text writing of the slave 2 (The digital setting value reference number 20 of the slave 2 is turned ON.)

<RTU mode>

Master → Instrument		Instrument → Master (Normal)	
Slave address	02H	Slave address	02H
Function code	05H	Function code	05H
Setting value No. (H)	00H	Setting value No. (H)	00H
Setting value No. (L)	13H	Setting value No. (L)	13H
Setting status (H)	FFH	Setting status (H)	FFH
Setting status (L)	00H	Setting status (L)	00H
CRC (L)	7DH	CRC (L)	7DH
CRC (H)	CCH	CRC (H)	CCH

<ASCII mode error check>

Error check: The CRC (L) and the CRC (H) parts are as follows.

LRC	E7H	LRC	E7H
-----	-----	-----	-----

*In case of a normal response, the response is same as a command message.

*The setting value number (Relative number) is "Reference number - 1".

(Decimal 19 (= 20 - 1) → Hexadecimal 13H)

*Set "F00HH" at the execution. In the key lock and the record ON/OFF, set "0000H" to turn OFF and "FF00H" to turn ON.

*When the slave address is set to 0, all slaves perform this command, but no slave responds.

7-5-6 Writing of analog setting values (Writing of single maintenance resistor)

Function code : 06 [06H]

The analog setting value specified is put into the value specified.

Example) Setting of the sensor correction value of Channel 1 of the slave 2 to 20
(Setting of the analog setting value reference number 40111 of the slave 2 to "20".)

<RTU mode>

Master → Instrument

Slave address	02H
Function code	06H
Setting value No. (H)	00H
Setting value No. (L)	6EH
Setting data (H)	00H
Setting data (L)	14H
CRC (L)	E8H
CRC (H)	2BH

Instrument → Master (Normal)

Slave address	02H
Function code	06H
Setting value No. (H)	00H
Setting value No. (L)	6EH
Setting data (H)	00H
Setting data (L)	14H
CRC (L)	E8H
CRC (H)	2BH

<ASCII mode error check>

Error check: The CRC (L) and the CRC (H) parts are as follows.

LRC	76H	LRC	76H
-----	-----	-----	-----

*In case of a normal response, the response is same as a command message.

*The setting value number (Relative number) is "Reference number - 40001".

(Decimal 110 (= 40111 - 40001) → Hexadecimal 6EH)

*When the slave address is set to 0, all slaves perform this command, but no slave responds.

7-5-7 Loop back test

Function code : 08 [08H]

The transmission check is performed between the master and slaves. The response is performed according to the diagnosis code specified. With this unit, "Return check by transmitting the received data as it is" is performed and the diagnosis code is fixed with "0000H".

Example) Execution of "Loop back test" in the slave 2

<RTU mode>

Master → Instrument			Instrument → Master (Normal)		
Slave address		02H	Slave address		02H
Function code		08H	Function code		08H
Diagnosis code (H)	Fixed	00H	Diagnosis code (H)	Fixed	00H
Diagnosis code (L)		00H	Diagnosis code (L)		00H
Optional data		*	Received data		*
Optional data		*	Received data		*
CRC (L)		*	CRC (L)		*
CRC (H)		*	CRC (H)		*

<ASCII mode error check>

Error check: The CRC (L) and the CRC (H) parts are as follows.

LRC	*	LRC	*
-----	---	-----	---

7-5-8 Writing multiple analog setting values (Writing to multiple maintenance registers)

Function code : 16 [10H]

The specified number of the analog setting values from the start number specified is put into the values specified. The data is arranged and sent by splitting into higher 8 bits and lower 8 bits in numerical order.

Example) Setting of the range high/low limit values and the decimal point of Channel 1 of the slave 2 to 0.0 to 100.0

(Setting of 3 analog setting value reference numbers from 40104 to 40106 of the slave

2)

Reference number	40104	40105	40106
Data	0 (0000H)	1000 (03E8H)	1 (0001H)

← Data example 0.0 to 100.0

<RTU mode>

Master → Instrument

Slave address	02H
Function code	10H
Start No. (H)	00H
End No. (L)	67H
Number of data (H)	00H
Number of data (L)	03H
Data pieces	06H
First data (H)	00H
First data (L)	00H
Second data (H)	03H
Second data (L)	E8H
Third data (H)	00H
Third data (L)	01H
CRC (L)	10H
CRC (H)	97H

Instrument → Master (Normal)

Slave address	02H
Function code	10H
Start No. (H)	00H
End No. (L)	67H
Number of data (H)	00H
Number of data (L)	03H
CRC (L)	31H
CRC (H)	E4H

<ASCII mode error check>

Error check: The CRC (L) and the CRC (H) parts are as follows.

LRC	92H	LRC	84H
-----	-----	-----	-----

*The start number (Relative number) is "Reference number - 40001".

(Decimal 103 (= 40104 - 40001) → Hexadecimal 67H)

*When the slave address is set to 0, all slaves perform this command, but no slave responds.

*There is a limitation on the data pieces for the message (that this unit can receive) that can be sent at a time. (Refer to Para. 7-4)

7-5-9 Reading of analog setting values (Only KR3S)

Function code: 60 [3CH]

“Analog setting values (expansion) with the continuous numbers” are read for the number of data specified from the start number specified.

The data is arranged by splitting into higher 8 bits and lower 8 bits in numerical order and configures a data of the response message.

The response example is same as “Function code 03”, but the start number (Relative number) is “Reference number – 50001”.

7-5-10 Writing multiple analog setting values (Only KR3S)

Function code: 61 [3DH]

The specified number of the analog setting values from the start number specified is put into the values specified.

The data is arranged and sent by splitting into higher 8 bits and lower 8 bits in numerical order.

The response example is same as “Function code 16”, but the start number (Relative number) is “Reference number – 50001”.

7-6 Process during abnormality

The followings are responses when there is an error in the message content from the master.

7-6-1 No response

In the following cases, the message is ignored and no response is performed.

- 1) When a transmission error (overrun, framing, parity, CRC, or LRC) is detected in the message
- 2) When the slave address in the message is not ones own address
- 3) When the data interval of the message is long
 - RTU mode... 28 bits hour or more
 - ASCII mode ... 1 second or more
- 4) When the transmission parameter does not match
- 5) When the received message exceeds 512 bytes

*When the slave address is "0" in the writing function, if there is no error in the message, the message is performed but no response is performed.

7-6-2 Error message response

When the following error is detected in the message content not having any error shown in Para. 7-6-1 from the master, the code showing its error content is responded as the "Error message".

The format of the error message is as follows.

Slave address
Function code + 80H
Error code
CRC (L)
CRC (H)

Function code	Function code + 80H
02	82H
03	83H
04	84H
06	86H
08	88H
16	90H
60	BCH
61	BDH

The error codes are as follows.

Error code	Content
01H	Defect of a function code When the function code not defined is received
02H	Defect of a Relative number (Reference number) When the received starting number or the received setting value number are other than defined
03H	Defect of the number of data In case of any of the followings 1) When the received function code and the number of data do not match • When “data pieces” is not twice the “number of data” in case of the function code “16” • When “Data count” disagrees with “Received data count” when the function code is “16” 2) When the number of data to be sent in response to the received message exceeds the number of data defined • Maximum 120 data (RTU) •Maximum 120 data (ASCII)
11H	Out of setting value range (Set error) In case of any of the followings 1) For the range No., etc. not defined 2) When the setting value (binary) exceeds the range of “-30000 to 30000” 3) When the decimal point data exceeds the range of “0 to 3” 4) When the RJ is set to “internal” for other than thermocouple input ranges 5) When the burnout is set to “enable” for other than thermocouple input ranges, etc.
12H	Setting impossible When a setting message is received in any of the following cases 1) When the parameter setting message for multiple channels at the parameter setting for each channel 2) When the parameter setting message for an optional function not built-in (“0” is responded to a message for reading.) 3) When the setting is being performed through the instrument and the Web screen 4) When the setting content is being registered (The registration starts 3 seconds after the last setting frame is received. The registration takes about 1 second.)

8 Reference table(KR2S:1 to 128CH/KR3S:1 to 128CH)

8-1 Digital setting values

R/W ... R: READ, W: WRITE

Reference number	Applied function code	R/W	Content	Detail
01	01 05	R W	Keylock	0 (0000h) = Keylock disabled 1 (FF00h) = Keylock enabled The figures shown in parentheses are for the function code 05. Error code: 01H, 02H, 03H, 11H, 12H
17	01 05	R W	Record ON/OFF	0 (0000h) = Record OFF 1 (FF00h) = Record ON The figures shown in parentheses are for the function code 05. Error code: 01H, 02H, 03H, 11H, 12H
20	05	W	Marker text writing	1 (FF00h) = Marker text writing Writing of the text with the number specified by 48002 to the group specified by the analog setting value reference number 48001 The figures shown in parentheses are for the function code 05. Error code: 01H, 02H, 03H, 11H, 12H

8-2 Digital input data

R/W ... R: READ, W: WRITE

Reference number	Applied function code	R/W	Content	Detail
10101 10102	02	R	CH1 status 1	Status expression in 2 bits 00: Measured data 01: Calculated data Error code: 01H, 02H, 03H
10105 10106 10107 10108	02	R	CH1 status 2	Status expression in 4 bits 0000: Normal data 0001: +Over range 0010: -Over range 0100: Burnout 1000: Invalid data Error code: 01H, 02H, 03H
10109 10110 10111 10112	02	R	CH1 alarm 1 activated CH1 alarm 2 activated CH1 alarm 3 activated CH1 alarm 4 activated	0: Not activated 1: Alarm activated Error code: 01H, 02H, 03
10117 10118	02	R	CH2 status 1	Status expression in 2 bits 00: Measured data 01: Calculated data Error code: 01H, 02H, 03H
10121 10122 10123 10124	02	R	CH2 status 2	Status expression in 4 bits 0000: Normal data 0001: +Over range 0010: -Over range 0100: Burnout 1000: Invalid data Error code: 01H, 02H, 03H
10125 10126 10127 10128	02	R	CH2 alarm 1 activated CH2 alarm 2 activated CH2 alarm 3 activated CH2 alarm 4 activated	0: Not activated 1: Alarm activated Error code: 01H, 02H, 03H
10133 10134	02	R	CH3 status 1	Status expression in 2 bits 00: Measured data 01: Calculated data Error code: 01H, 02H, 03H
10137 10138 10139 10140	02	R	CH3 status 2	Status expression in 4 bits 0000: Normal data 0001: +Over range 0010: -Over range 0100: Burnout 1000: Invalid data Error code: 01H, 02H, 03H
10141 10142 10143 10144	02	R	CH3 alarm 1 activated CH3 alarm 2 activated CH3 alarm 3 activated CH3 alarm 4 activated	0: Not activated 1: Alarm activated Error code: 01H, 02H, 03
10149 to 10160	02	R	From CH4 event level 1 to CH4 event level 4 activated	Same as CH1

Reference number	Applied function code	R/W	Content	Detail
10165 to 10176	02	R	From CH5 event level 1 to CH5 event level 4 activated	Same as CH1
10181 to 10192	02	R	From CH6 event level 1 to CH6 event level 4 activated	Same as CH1
10197 to 10208	02	R	From CH7 event level 1 to CH7 event level 4 activated	Same as CH1
10213 to 10224	02	R	From CH8 event level 1 to CH8 event level 4 activated	Same as CH1
10229 to 10240	02	R	From CH9 event level 1 to CH9 event level 4 activated	Same as CH1
10245 to 10256	02	R	From CH10 event level 1 to CH10 event level 4 activated	Same as CH1
10261 to 10272	02	R	From CH11 event level 1 to CH11 event level 4 activated	Same as CH1
10277 to 10288	02	R	From CH12 event level 1 to CH12 event level 4 activated	Same as CH1
10293 to 10304	02	R	From CH13 event level 1 to CH13 event level 4 activated	Same as CH1
10309 to 10320	02	R	From CH14 event level 1 to CH14 event level 4 activated	Same as CH1
10325 to 10336	02	R	From CH15 event level 1 to CH15 event level 4 activated	Same as CH1
10341 to 10352	02	R	From CH16 event level 1 to CH16 event level 4 activated	Same as CH1
10357 to 10368	02	R	From CH17 event level 1 to CH17 event level 4 activated	Same as CH1
10373 to 10384	02	R	From CH18 event level 1 to CH18 event level 4 activated	Same as CH1
10389 to 10400	02	R	From CH19 event level 1 to CH19 event level 4 activated	Same as CH1
10405 to 10416	02	R	From CH20 event level 1 to CH20 event level 4 activated	Same as CH1
10421 to 10432	02	R	From CH21 event level 1 to CH21 event level 4 activated	Same as CH1
10437 to 10448	02	R	From CH22 event level 1 to CH22 event level 4 activated	Same as CH1
10453 to 10464	02	R	From CH23 event level 1 to CH23 event level 4 activated	Same as CH1
10469 to 10480	02	R	From CH24 event level 1 to CH24 event level 4 activated	Same as CH1
10485 to 10496	02	R	From CH25 event level 1 to CH25 event level 4 activated	Same as CH1
10501 to 10512	02	R	From CH26 event level 1 to CH26 event level 4 activated	Same as CH1
10517 to 10528	02	R	From CH27 event level 1 to CH27 event level 4 activated	Same as CH1
10533 to 10544	02	R	From CH28 event level 1 to CH28 event level 4 activated	Same as CH1
10549 to 10560	02	R	From CH29 event level 1 to CH29 event level 4 activated	Same as CH1

Reference number	Applied function code	R/W	Content	Detail
10565 to 10576	02	R	From CH30 event level 1 to CH30 event level 4 activated	Same as CH1
10581 to 10592	02	R	From CH31 event level 1 to CH31 event level 4 activated	Same as CH1
10597 to 10608	02	R	From CH32 event level 1 to CH32 event level 4 activated	Same as CH1
10613 to 10624	02	R	From CH33 event level 1 to CH33 event level 4 activated	Same as CH1
10629 to 10640	02	R	From CH34 event level 1 to CH34 event level 4 activated	Same as CH1
10645 to 10656	02	R	From CH35 event level 1 to CH35 event level 4 activated	Same as CH1
10661 to 10672	02	R	From CH36 event level 1 to CH36 event level 4 activated	Same as CH1
10677 to 10688	02	R	From CH37 event level 1 to CH37 event level 4 activated	Same as CH1
10693 to 10704	02	R	From CH38 event level 1 to CH38 event level 4 activated	Same as CH1
10709 to 10720	02	R	From CH39 event level 1 to CH39 event level 4 activated	Same as CH1
10725 to 10736	02	R	From CH40 event level 1 to CH40 event level 4 activated	Same as CH1
10741 to 10752	02	R	From CH41 event level 1 to CH41 event level 4 activated	Same as CH1
10757 to 10768	02	R	From CH42 event level 1 to CH42 event level 4 activated	Same as CH1
10773 to 10784	02	R	From CH43 event level 1 to CH43 event level 4 activated	Same as CH1
10789 to 10800	02	R	From CH44 event level 1 to CH44 event level 4 activated	Same as CH1
10805 to 10816	02	R	From CH45 event level 1 to CH45 event level 4 activated	Same as CH1
10821 to 10832	02	R	From CH46 event level 1 to CH46 event level 4 activated	Same as CH1
10837 to 10848	02	R	From CH47 event level 1 to CH47 event level 4 activated	Same as CH1
10843 to 10854	02	R	From CH48 event level 1 to CH48 event level 4 activated	Same as CH1
10869 to 10880	02	R	From CH49 event level 1 to CH49 event level 4 activated	Same as CH1
10885 to 10896	02	R	From CH50 event level 1 to CH50 event level 4 activated	Same as CH1
10901 to 10912	02	R	From CH51 event level 1 to CH51 event level 4 activated	Same as CH1
10917 to 10928	02	R	From CH52 event level 1 to CH52 event level 4 activated	Same as CH1
10933 to 10944	02	R	From CH53 event level 1 to CH53 event level 4 activated	Same as CH1
10949 to 10960	02	R	From CH54 event level 1 to CH54 event level 4 activated	Same as CH1

Reference number	Applied function code	R/W	Content	Detail
10965 to 10976	02	R	From CH55 event level 1 to CH55 event level 4 activated	Same as CH1
10981 to 10992	02	R	From CH56 event level 1 to CH56 event level 4 activated	Same as CH1
10997 to 11008	02	R	From CH57 event level 1 to CH57 event level 4 activated	Same as CH1
11013 to 11024	02	R	From CH58 event level 1 to CH58 event level 4 activated	Same as CH1
11029 to 11040	02	R	From CH59 event level 1 to CH59 event level 4 activated	Same as CH1
11045 to 11056	02	R	From CH60 event level 1 to CH60 event level 4 activated	Same as CH1
11061 to 11072	02	R	From CH61 event level 1 to CH61 event level 4 activated	Same as CH1
11077 to 11088	02	R	From CH62 event level 1 to CH62 event level 4 activated	Same as CH1
11093 to 11104	02	R	From CH63 event level 1 to CH63 event level 4 activated	Same as CH1
11109 to 11120	02	R	From CH64 event level 1 to CH64 event level 4 activated	Same as CH1
11125 to 11136	02	R	From CH65 event level 1 to CH65 event level 4 activated	Same as CH1
11141 to 11152	02	R	From CH66 event level 1 to CH66 event level 4 activated	Same as CH1
11157 to 11168	02	R	From CH67 event level 1 to CH67 event level 4 activated	Same as CH1
11173 to 11184	02	R	From CH68 event level 1 to CH68 event level 4 activated	Same as CH1
11189 to 11200	02	R	From CH69 event level 1 to CH69 event level 4 activated	Same as CH1
11205 to 11216	02	R	From CH70 event level 1 to CH70 event level 4 activated	Same as CH1
11221 to 11232	02	R	From CH71 event level 1 to CH71 event level 4 activated	Same as CH1
11237 to 11248	02	R	From CH72 event level 1 to CH72 event level 4 activated	Same as CH1
11253 to 11264	02	R	From CH73 event level 1 to CH73 event level 4 activated	Same as CH1
11269 to 11280	02	R	From CH74 event level 1 to CH74 event level 4 activated	Same as CH1
11285 to 11296	02	R	From CH75 event level 1 to CH75 event level 4 activated	Same as CH1
11301 to 11312	02	R	From CH76 event level 1 to CH76 event level 4 activated	Same as CH1
11317 to 11328	02	R	From CH77 event level 1 to CH77 event level 4 activated	Same as CH1
11333 to 11344	02	R	From CH78 event level 1 to CH78 event level 4 activated	Same as CH1
11349 to 11360	02	R	From CH79 event level 1 to CH79 event level 4 activated	Same as CH1

Reference number	Applied function code	R/W	Content	Detail
11365 to 11376	02	R	From CH80 event level 1 to CH80 event level 4 activated	Same as CH1
11381 to 11392	02	R	From CH81 event level 1 to CH81 event level 4 activated	Same as CH1
11397 to 11408	02	R	From CH82 event level 1 to CH82 event level 4 activated	Same as CH1
11413 to 11424	02	R	From CH83 event level 1 to CH83 event level 4 activated	Same as CH1
11429 to 11440	02	R	From CH84 event level 1 to CH84 event level 4 activated	Same as CH1
11445 to 11456	02	R	From CH85 event level 1 to CH85 event level 4 activated	Same as CH1
11461 to 11472	02	R	From CH86 event level 1 to CH86 event level 4 activated	Same as CH1
11477 to 11488	02	R	From CH87 event level 1 to CH87 event level 4 activated	Same as CH1
11493 to 11504	02	R	From CH88 event level 1 to CH88 event level 4 activated	Same as CH1
11509 to 11520	02	R	From CH89 event level 1 to CH89 event level 4 activated	Same as CH1
11525 to 11536	02	R	From CH90 event level 1 to CH90 event level 4 activated	Same as CH1
11541 to 11552	02	R	From CH91 event level 1 to CH91 event level 4 activated	Same as CH1
11557 to 11568	02	R	From CH92 event level 1 to CH92 event level 4 activated	Same as CH1
11573 to 11584	02	R	From CH93 event level 1 to CH93 event level 4 activated	Same as CH1
11589 to 11600	02	R	From CH94 event level 1 to CH94 event level 4 activated	Same as CH1
11605 to 11616	02	R	From CH95 event level 1 to CH95 event level 4 activated	Same as CH1
11621 to 11632	02	R	From CH96 event level 1 to CH96 event level 4 activated	Same as CH1
11637 to 11648	02	R	From CH97 event level 1 to CH97 event level 4 activated	Same as CH1
11653 to 11664	02	R	From CH98 event level 1 to CH98 event level 4 activated	Same as CH1
11669 to 11680	02	R	From CH99 event level 1 to CH99 event level 4 activated	Same as CH1
11685 to 11696	02	R	From CH100 event level 1 to CH100 event level 4 activated	Same as CH1
11701 to 11712	02	R	From CH101 event level 1 to CH101 event level 4 activated	Same as CH1
11717 to 11728	02	R	From CH102 event level 1 to CH102 event level 4 activated	Same as CH1
11733 to 11744	02	R	From CH103 event level 1 to CH103 event level 4 activated	Same as CH1
11749 to 11760	02	R	From CH104 event level 1 to CH104 event level 4 activated	Same as CH1

Reference number	Applied function code	R/W	Content	Detail
11765 to 11776	02	R	From CH105 event level 1 to CH105 event level 4 activated	Same as CH1
11781 to 11792	02	R	From CH106 event level 1 to CH106 event level 4 activated	Same as CH1
11797 to 11808	02	R	From CH107 event level 1 to CH107 event level 4 activated	Same as CH1
11813 to 11824	02	R	From CH108 event level 1 to CH108 event level 4 activated	Same as CH1
11829 to 11840	02	R	From CH109 event level 1 to CH109 event level 4 activated	Same as CH1
11845 to 11856	02	R	From CH110 event level 1 to CH110 event level 4 activated	Same as CH1
11861 to 11872	02	R	From CH111 event level 1 to CH111 event level 4 activated	Same as CH1
11877 to 11888	02	R	From CH112 event level 1 to CH112 event level 4 activated	Same as CH1
11893 to 11904	02	R	From CH113 event level 1 to CH113 event level 4 activated	Same as CH1
11909 to 11920	02	R	From CH114 event level 1 to CH114 event level 4 activated	Same as CH1
11925 to 11936	02	R	From CH115 event level 1 to CH115 event level 4 activated	Same as CH1
11941 to 11952	02	R	From CH116 event level 1 to CH116 event level 4 activated	Same as CH1
11957 to 11968	02	R	From CH117 event level 1 to CH117 event level 4 activated	Same as CH1
11973 to 11984	02	R	From CH118 event level 1 to CH118 event level 4 activated	Same as CH1
11989 to 12000	02	R	From CH119 event level 1 to CH119 event level 4 activated	Same as CH1
12005 to 12016	02	R	From CH120 event level 1 to CH120 event level 4 activated	Same as CH1
12021 to 12032	02	R	From CH121 event level 1 to CH121 event level 4 activated	Same as CH1
12037 to 12048	02	R	From CH122 event level 1 to CH122 event level 4 activated	Same as CH1
12053 to 12064	02	R	From CH123 event level 1 to CH123 event level 4 activated	Same as CH1
12069 to 12080	02	R	From CH124 event level 1 to CH124 event level 4 activated	Same as CH1
12085 to 12096	02	R	From CH125 event level 1 to CH125 event level 4 activated	Same as CH1
12101 to 12112	02	R	From CH126 event level 1 to CH126 event level 4 activated	Same as CH1
12117 to 12128	02	R	From CH127 event level 1 to CH127 event level 4 activated	Same as CH1
12133 to 12144	02	R	From CH128 event level 1 to CH128 event level 4 activated	Same as CH1

8-3 Analog input data

8-3-1 Reading of instrument specifications

R/W ... R: READ, W: WRITE

Reference number	Applied function code	R/W	Content	Detail
30001	04	R	Model 1, 2	ASCII "KR"
30002	04	R	Model 3, 4	ASCII "2S"
30003	04	R	Model 5, 6	ASCII 2 digits
30009	04	R	ROM version character 1, 2	ASCII 2 digits
30010	04	R	ROM version character 3, 4	ASCII 2 digits
30011	04	R	ROM version character 5, 6	ASCII 2 digits
30012	04	R	ROM version character 7, 8	ASCII 2 digits
30017	04	R	Input point	ASCII 2 digits
30025	04	R	Alarm output point	ASCII 2 digits
30026	04	R	External contact	Optional external contact Enable: 1, Disable: 0
30079	04	R	Serial number 1, 2	ASCII 2 digits
30080	04	R	Serial number 3, 4	ASCII 2 digits
30081	04	R	Serial number 5, 6	ASCII 2 digits
30082	04	R	Serial number 7, 8	ASCII 2 digits
30083	04	R	Serial number 9, 10	ASCII 2 digits
30084	04	R	Serial number 11, 12	ASCII 2 digits
30085	04	R	Serial number 13, 14	ASCII 2 digits
30086	04	R	Serial number 15, 16	ASCII 2 digits
30087	04	R	Built date 1, 2	ASCII 2 digits
30088	04	R	Built date 3, 4	ASCII 2 digits
30089	04	R	Built date 5, 6	ASCII 2 digits
30090	04	R	Built date 7, 8	ASCII 2 digits
30091	04	R	MAC address 1, 2	MAC address 1, 2
30092	04	R	MAC address 3, 4	MAC address 3, 4
30093	04	R	MAC address 5, 6	MAC address 5, 6
30094	04	R	Communication kind	0: High order 1: Low order (read) 2: Low order (write)

8-3-2 Reading of measured data

R/W ... R: READ, W: WRITE

Reference number	Applied function code	R/W	Content	Detail
30101	04	R	CH1 Measured data	DATA: -30000 to 30000 32767: High limit over flow -32767: Low limit over flow 32765: RJ error 32766: Burnout -32765: Invalid data 32764: Calculation error Error code: 01H, 02H, 03H, 12H
30102	04	R	CH1 decimal point/status	Data status, event status, decimal point (discussed later) Error code: 01H, 02H, 03H, 12H
30103	04	R	CH2 measured data	Same as CH1
30104	04	R	CH2 decimal point/status	Same as CH1
30105	04	R	CH3 measured data	Same as CH1
30106	04	R	CH3 decimal point/status	Same as CH1
30107	04	R	CH4 measured data	Same as CH1
30108	04	R	CH4 decimal point/status	Same as CH1
30109	04	R	CH5 measured data	Same as CH1
30110	04	R	CH5 decimal point/status	Same as CH1
30111	04	R	CH6 measured data	Same as CH1
30112	04	R	CH6 decimal point/status	Same as CH1
30113	04	R	CH7 measured data	Same as CH1
30114	04	R	CH7 decimal point/status	Same as CH1
30115	04	R	CH8 measured data	Same as CH1
30116	04	R	CH8 decimal point/status	Same as CH1
30117	04	R	CH9 measured data	Same as CH1
30118	04	R	CH9 decimal point/status	Same as CH1
30119	04	R	CH10 measured data	Same as CH1
30120	04	R	CH10 decimal point/status	Same as CH1
30121	04	R	CH11 measured data	Same as CH1
30122	04	R	CH11 decimal point/status	Same as CH1
30123	04	R	CH12 measured data	Same as CH1
30124	04	R	CH12 decimal point/status	Same as CH1
30125	04	R	CH13 measured data	Same as CH1
30126	04	R	CH13 decimal point/status	Same as CH1
30127	04	R	CH14 measured data	Same as CH1
30128	04	R	CH14 decimal point/status	Same as CH1
30129	04	R	CH15 measured data	Same as CH1
30130	04	R	CH15 decimal point/status	Same as CH1
30131	04	R	CH16 measured data	Same as CH1
30132	04	R	CH16 decimal point/status	Same as CH1
30133	04	R	CH17 measured data	Same as CH1
30134	04	R	CH17 decimal point/status	Same as CH1
30135	04	R	CH18 measured data	Same as CH1
30136	04	R	CH18 decimal point/status	Same as CH1
30137	04	R	CH19 measured data	Same as CH1

Reference number	Applied function code	R/W	Content	Detail
30138	04	R	CH19 decimal point/status	Same as CH1
30139	04	R	CH20 measured data	Same as CH1
30140	04	R	CH20 decimal point/status	Same as CH1
30141	04	R	CH21 measured data	Same as CH1
30142	04	R	CH21 decimal point/status	Same as CH1
30143	04	R	CH22 measured data	Same as CH1
30144	04	R	CH22 decimal point/status	Same as CH1
30145	04	R	CH23 measured data	Same as CH1
30146	04	R	CH23 decimal point/status	Same as CH1
30147	04	R	CH24 measured data	Same as CH1
30148	04	R	CH24 decimal point/status	Same as CH1
30149	04	R	CH25 measured data	Same as CH1
30150	04	R	CH25 decimal point/status	Same as CH1
30151	04	R	CH26 measured data	Same as CH1
30152	04	R	CH26 decimal point/status	Same as CH1
30153	04	R	CH27 measured data	Same as CH1
30154	04	R	CH27 decimal point/status	Same as CH1
30155	04	R	CH28 measured data	Same as CH1
30156	04	R	CH28 decimal point/status	Same as CH1
30157	04	R	CH29 measured data	Same as CH1
30158	04	R	CH29 decimal point/status	Same as CH1
30159	04	R	CH30 measured data	Same as CH1
30160	04	R	CH30 decimal point/status	Same as CH1
30161	04	R	CH31 measured data	Same as CH1
30162	04	R	CH31 decimal point/status	Same as CH1
30163	04	R	CH32 measured data	Same as CH1
30164	04	R	CH32 decimal point/status	Same as CH1
30165	04	R	CH33 measured data	Same as CH1
30166	04	R	CH33 decimal point/status	Same as CH1
30167	04	R	CH34 measured data	Same as CH1
30168	04	R	CH34 decimal point/status	Same as CH1
30169	04	R	CH35 measured data	Same as CH1
30170	04	R	CH35 decimal point/status	Same as CH1
30171	04	R	CH36 measured data	Same as CH1
30172	04	R	CH36 decimal point/status	Same as CH1
30173	04	R	CH37 measured data	Same as CH1
30174	04	R	CH37 decimal point/status	Same as CH1
30175	04	R	CH38 measured data	Same as CH1
30176	04	R	CH38 decimal point/status	Same as CH1
30177	04	R	CH39 measured data	Same as CH1
30178	04	R	CH39 decimal point/status	Same as CH1
30179	04	R	CH40 measured data	Same as CH1
30180	04	R	CH40 decimal point/status	Same as CH1
30181	04	R	CH41 measured data	Same as CH1
30182	04	R	CH41 decimal point/status	Same as CH1
30183	04	R	CH42 measured data	Same as CH1
30184	04	R	CH42 decimal point/status	Same as CH1
30185	04	R	CH43 measured data	Same as CH1
30186	04	R	CH43 decimal point/status	Same as CH1

Reference number	Applied function code	R/W	Content	Detail
30187	04	R	CH44 measured data	Same as CH1
30188	04	R	CH44 decimal point/status	Same as CH1
30189	04	R	CH45 measured data	Same as CH1
30190	04	R	CH45 decimal point/status	Same as CH1
30191	04	R	CH46 measured data	Same as CH1
30192	04	R	CH46 decimal point/status	Same as CH1
30193	04	R	CH47 measured data	Same as CH1
30194	04	R	CH47 decimal point/status	Same as CH1
30195	04	R	CH48 measured data	Same as CH1
30196	04	R	CH48 decimal point/status	Same as CH1
30197	04	R	CH49 measured data	Same as CH1
30198	04	R	CH49 decimal point/status	Same as CH1
30199	04	R	CH50 measured data	Same as CH1
30200	04	R	CH50 decimal point/status	Same as CH1
30201	04	R	CH51 measured data	Same as CH1
30202	04	R	CH51 decimal point/status	Same as CH1
30203	04	R	CH52 measured data	Same as CH1
30204	04	R	CH52 decimal point/status	Same as CH1
30205	04	R	CH53 measured data	Same as CH1
30206	04	R	CH53 decimal point/status	Same as CH1
30207	04	R	CH54 measured data	Same as CH1
30208	04	R	CH54 decimal point/status	Same as CH1
30209	04	R	CH55 measured data	Same as CH1
30210	04	R	CH55 decimal point/status	Same as CH1
30211	04	R	CH56 measured data	Same as CH1
30212	04	R	CH56 decimal point/status	Same as CH1
30213	04	R	CH57 measured data	Same as CH1
30214	04	R	CH57 decimal point/status	Same as CH1
30215	04	R	CH58 measured data	Same as CH1
30216	04	R	CH58 decimal point/status	Same as CH1
30217	04	R	CH59 measured data	Same as CH1
30218	04	R	CH59 decimal point/status	Same as CH1
30219	04	R	CH60 measured data	Same as CH1
30220	04	R	CH60 decimal point/status	Same as CH1
30221	04	R	CH61 measured data	Same as CH1
30222	04	R	CH61 decimal point/status	Same as CH1
30223	04	R	CH62 measured data	Same as CH1
30224	04	R	CH62 decimal point/status	Same as CH1
30225	04	R	CH63 measured data	Same as CH1
30226	04	R	CH63 decimal point/status	Same as CH1
30227	04	R	CH64 measured data	Same as CH1
30228	04	R	CH64 decimal point/status	Same as CH1
30229	04	R	CH65 measured data	Same as CH1
30230	04	R	CH65 decimal point/status	Same as CH1
30231	04	R	CH66 measured data	Same as CH1
30232	04	R	CH66 decimal point/status	Same as CH1
30233	04	R	CH67 measured data	Same as CH1
30234	04	R	CH67 decimal point/status	Same as CH1
30235	04	R	CH68 measured data	Same as CH1

Reference number	Applied function code	R/W	Content	Detail
30236	04	R	CH68 decimal point/status	Same as CH1
30237	04	R	CH69 measured data	Same as CH1
30238	04	R	CH69 decimal point/status	Same as CH1
30239	04	R	CH70 measured data	Same as CH1
30240	04	R	CH70 decimal point/status	Same as CH1
30241	04	R	CH71 measured data	Same as CH1
30242	04	R	CH71 decimal point/status	Same as CH1
30243	04	R	CH72 measured data	Same as CH1
30244	04	R	CH72 decimal point/status	Same as CH1
30245	04	R	CH73 measured data	Same as CH1
30246	04	R	CH73 decimal point/status	Same as CH1
30247	04	R	CH74 measured data	Same as CH1
30248	04	R	CH74 decimal point/status	Same as CH1
30249	04	R	CH75 measured data	Same as CH1
30250	04	R	CH75 decimal point/status	Same as CH1
30251	04	R	CH76 measured data	Same as CH1
30252	04	R	CH76 decimal point/status	Same as CH1
30253	04	R	CH77 measured data	Same as CH1
30254	04	R	CH77 decimal point/status	Same as CH1
30255	04	R	CH78 measured data	Same as CH1
30256	04	R	CH78 decimal point/status	Same as CH1
30257	04	R	CH79 measured data	Same as CH1
30258	04	R	CH79 decimal point/status	Same as CH1
30259	04	R	CH80 measured data	Same as CH1
30260	04	R	CH80 decimal point/status	Same as CH1
30261	04	R	CH81 measured data	Same as CH1
30262	04	R	CH81 decimal point/status	Same as CH1
30263	04	R	CH82 measured data	Same as CH1
30264	04	R	CH82 decimal point/status	Same as CH1
30265	04	R	CH83 measured data	Same as CH1
30266	04	R	CH83 decimal point/status	Same as CH1
30267	04	R	CH84 measured data	Same as CH1
30268	04	R	CH84 decimal point/status	Same as CH1
30269	04	R	CH85 measured data	Same as CH1
30270	04	R	CH85 decimal point/status	Same as CH1
30271	04	R	CH86 measured data	Same as CH1
30272	04	R	CH86 decimal point/status	Same as CH1
30273	04	R	CH87 measured data	Same as CH1
30274	04	R	CH87 decimal point/status	Same as CH1
30275	04	R	CH88 measured data	Same as CH1
30276	04	R	CH88 decimal point/status	Same as CH1
30277	04	R	CH89 measured data	Same as CH1
30278	04	R	CH89 decimal point/status	Same as CH1
30279	04	R	CH90 measured data	Same as CH1
30280	04	R	CH90 decimal point/status	Same as CH1
30281	04	R	CH91 measured data	Same as CH1
30282	04	R	CH91 decimal point/status	Same as CH1
30283	04	R	CH92 measured data	Same as CH1
30284	04	R	CH92 decimal point/status	Same as CH1

Reference number	Applied function code	R/W	Content	Detail
30285	04	R	CH93 measured data	Same as CH1
30286	04	R	CH93 decimal point/status	Same as CH1
30287	04	R	CH94 measured data	Same as CH1
30288	04	R	CH94 decimal point/status	Same as CH1
30289	04	R	CH95 measured data	Same as CH1
30290	04	R	CH95 decimal point/status	Same as CH1
30291	04	R	CH96 measured data	Same as CH1
30292	04	R	CH96 decimal point/status	Same as CH1
30293	04	R	CH97 measured data	Same as CH1
30294	04	R	CH97 decimal point/status	Same as CH1
30295	04	R	CH98 measured data	Same as CH1
30296	04	R	CH98 decimal point/status	Same as CH1
30297	04	R	CH99 measured data	Same as CH1
30298	04	R	CH99 decimal point/status	Same as CH1
30299	04	R	CH100 measured data	Same as CH1
30300	04	R	CH100 decimal point/status	Same as CH1
30301	04	R	CH101 measured data	Same as CH1
30302	04	R	CH101 decimal point/status	Same as CH1
30303	04	R	CH102 measured data	Same as CH1
30304	04	R	CH102 decimal point/status	Same as CH1
30305	04	R	CH103 measured data	Same as CH1
30306	04	R	CH103 decimal point/status	Same as CH1
30307	04	R	CH104 measured data	Same as CH1
30308	04	R	CH104 decimal point/status	Same as CH1
30309	04	R	CH105 measured data	Same as CH1
30310	04	R	CH105 decimal point/status	Same as CH1
30311	04	R	CH106 measured data	Same as CH1
30312	04	R	CH106 decimal point/status	Same as CH1
30313	04	R	CH107 measured data	Same as CH1
30314	04	R	CH107 decimal point/status	Same as CH1
30315	04	R	CH108 measured data	Same as CH1
30316	04	R	CH108 decimal point/status	Same as CH1
30317	04	R	CH109 measured data	Same as CH1
30318	04	R	CH109 decimal point/status	Same as CH1
30319	04	R	CH110 measured data	Same as CH1
30320	04	R	CH110 decimal point/status	Same as CH1
30321	04	R	CH111 measured data	Same as CH1
30322	04	R	CH111 decimal point/status	Same as CH1
30323	04	R	CH112 measured data	Same as CH1
30324	04	R	CH112 decimal point/status	Same as CH1
30325	04	R	CH113 measured data	Same as CH1
30326	04	R	CH113 decimal point/status	Same as CH1
30327	04	R	CH114 measured data	Same as CH1
30328	04	R	CH114 decimal point/status	Same as CH1
30329	04	R	CH115 measured data	Same as CH1
30330	04	R	CH115 decimal point/status	Same as CH1
30331	04	R	CH116 measured data	Same as CH1
30332	04	R	CH116 decimal point/status	Same as CH1
30333	04	R	CH117 measured data	Same as CH1

Reference number	Applied function code	R/W	Content	Detail
30334	04	R	CH117 decimal point/status	Same as CH1
30335	04	R	CH118 measured data	Same as CH1
30336	04	R	CH118 decimal point/status	Same as CH1
30337	04	R	CH119 measured data	Same as CH1
30338	04	R	CH119 decimal point/status	Same as CH1
30339	04	R	CH120 measured data	Same as CH1
30340	04	R	CH120 decimal point/status	Same as CH1
30341	04	R	CH121 measured data	Same as CH1
30342	04	R	CH121 decimal point/status	Same as CH1
30343	04	R	CH122 measured data	Same as CH1
30344	04	R	CH122 decimal point/status	Same as CH1
30345	04	R	CH123 measured data	Same as CH1
30346	04	R	CH123 decimal point/status	Same as CH1
30347	04	R	CH124 measured data	Same as CH1
30348	04	R	CH124 decimal point/status	Same as CH1
30349	04	R	CH125 measured data	Same as CH1
30350	04	R	CH125 decimal point/status	Same as CH1
30351	04	R	CH126 measured data	Same as CH1
30352	04	R	CH126 decimal point/status	Same as CH1
30353	04	R	CH127 measured data	Same as CH1
30354	04	R	CH127 decimal point/status	Same as CH1
30355	04	R	CH128 measured data	Same as CH1
30356	04	R	CH128 decimal point/status	Same as CH1

*About the exponent part form data format.

MSB(15)	(14)	(5)	(4)	(3)	LSB(0)
Integer part sign	Integer part(10 bit)	Exponent part sign	Exponent part(4 bit)		

Integer part sign :sign 0(+)/1(-)

Exponent part sign :sign 0(+)/1(-)

*About the error

1023 :Over High limit over flow

1022 :Under Low limit over flow

1021 :RJ RJ error

1020 :BURN Burnout

1019 :Cal Calculation error

1018 :Other error

1017 :Invalid data

* About the decimal point/status information

MSB(15)	(11)	(7)	(3)	LSB(0)								
0	0	0	SCALE	EV4	EV3	EV2	EV1	ERR	BURN	OF	UF	DP

SCALE : Display scale 0(standard)/1(exponent)

EV1 to 4 : Each alarm status 0 (Not activated)/1 (activated)

ERR : Input part status 0 (normal)/1 (abnormal)

BURN : Sensor disconnection 0 (Not activated)/1 (activated)

OF : Overflow error 0 (Not activated)/1 (activated)

UF : Underflow error 0 (Not activated)/1 (activated)

DP : Data decimal place |0|0|0|0|: 0, |0|0|0|1|: 1, |0|0|1|0|: 2, |0|0|1|1|: 3

8-4 Analog setting values

8-4-1 Common parameters (Date/time, High order communications, etc.)

R/W ... R: READ, W: WRITE

Reference number	Applied function code	R/W	Content	Detail
40001	03	R	Date/time setting 1, 2	Year, ASCII 2 digits 00: Year 2000 to 99: Year 2099 Error code: 01H, 02H, 03H, 11H, 12H
	06	W		
	16	W		
40002	03	R	Date/time setting 3, 4	Month, ASCII 2 digits Error code: 01H, 02H, 03H, 11H, 12H
	06	W		
	16	W		
40003	03	R	Date/time setting 5, 6	Day, ASCII 2 digits Error code: 01H, 02H, 03H, 11H, 12H
	06	W		
	16	W		
40004	03	R	Date/time setting 7, 8	Hour, ASCII 2 digits Error code: 01H, 02H, 03H, 11H, 12H
	06	W		
	16	W		
40005	03	R	Date/time setting 9, 10	Minute, ASCII 2 digits Error code: 01H, 02H, 03H, 11H, 12H
	06	W		
	16	W		
40006	03	R	Date/time setting 11, 12	Second, ASCII 2 digits Error code: 01H, 02H, 03H, 11H, 12H
	06	W		
	16	W		
40031	03	R	High order transmission mode	0: RTU mode, 1: ASCII mode Error code: 01H, 02H, 03H, 11H, 12H
	06	W		
	16	W		
40032	03	R	High order I instrument address	1 to 31 Error code: 01H, 02H, 03H, 11H, 12H
	06	W		
	16	W		
40033	03	R	High order transmission speed	3: 9600bps, 4: 19200bps Error code: 01H, 02H, 03H, 11H, 12H
	06	W		
	16	W		
40034	03	R	High order transmission character	0: 8N1, 1: 8N2, 2: 8E1, 3: 8E2, 4: 8O1, 5: 8O2, 6: 7E1, 7: 7E2, 8: 7O1, 9: 7O2 Error code: 01H, 02H, 03H, 11H, 12H
	06	W		
	16	W		
40072	03	R	Decimal point mark	0: Dot, 1: Comma Error code: 01H, 02H, 03H, 11H, 12H
	06	W		
	16	W		
40073	03	R	Frequency selection	1: 50Hz, 2: 60Hz Error code: 01H, 02H, 03H, 11H, 12H
	06	W		
	16	W		
40074	03	R	Filter level	0 to 3 Error code: 01H, 02H, 03H, 11H, 12H
	06	W		
	16	W		
40075	03	R	Number of using group	1 to 5 Error code: 01H, 02H, 03H, 11H, 12H
	06	W		
	16	W		

Reference number	Applied function code	R/W	Content	Detail
40076	03 06 16	R W W	At writing message, method of using remote contact	0: Standard, 1: Binary Error code: 01H, 02H, 03H, 11H, 12H
40077	03 06 16	R W W	Overwriting mode	0: OFF, 1: ON Error code: 01H, 02H, 03H, 11H, 12H
40078	03 06 16	R W W	Remote contact selection	0: CF card, 1: USB memory Error code: 01H, 02H, 03H, 11H, 12H
40079	03 06 16	R W W	Key lock operation Restriction item	Bit0: Setting, Bit1: START/STOP key, Bit2: Display selection, Bit3: Group selection Error code: 01H, 02H, 03H, 11H, 12H
40080	03 06 16	R W W	PEN coordinates	0: Smoothness, 1: Directly Error code: 01H, 02H, 03H, 11H, 12H
40081	03 06 16	R W W	Calculation reset/ Automatic reset ON/OFF	0: OFF, 1: ON Error code: 01H, 02H, 03H, 11H, 12H
40082	03 06 16	R W W	Calculation reset/ at reference	ASCII 2 digits, 00 to 23 Error code: 01H, 02H, 03H, 11H, 12H
40083	03 06 16	R W W	Calculation reset/ for reference	ASCII 2 digits, 00 to 59 Error code: 01H, 02H, 03H, 11H, 12H
40084	03 06 16	R W W	Calculation reset/ at interval	ASCII 2 digits, 00 to 23 Error code: 01H, 02H, 03H, 11H, 12H
40085	03 06 16	R W W	Calculation reset/ for interval	ASCII 2 digits, 00 to 59 Error code: 01H, 02H, 03H, 11H, 12H
40086	03 06 16	R W W	Calculation reset/ reset by DI	1 to 8: Channel number, 0: None Error code: 01H, 02H, 03H, 11H, 12H
40087	03 06 16	R W W	Calculation reset/ Setting method	0: All CH commonness, 1: CH individual Error code: 01H, 02H, 03H, 11H, 12H
40091	03 06 16	R W W	Instrument name 1, 2	ASCII 2 characters, Shift JIS 1 character Error code: 01H, 02H, 03H, 11H, 12H
40092	03 06 16	R W W	Instrument name 3, 4	ASCII 2 characters, Shift JIS 1 character Error code: 01H, 02H, 03H, 11H, 12H
40093	03 06 16	R W W	Instrument name 5, 6	ASCII 2 characters, Shift JIS 1 character Error code: 01H, 02H, 03H, 11H, 12H
40094	03 06 16	R W W	Instrument name 7, 8	ASCII 2 characters, Shift JIS 1 character Error code: 01H, 02H, 03H, 11H, 12H

Reference number	Applied function code	R/W	Content	Detail
40095	03 06 16	R W W	Instrument name 9, 10	ASCII 2 characters, Shift JIS 1 character Error code: 01H, 02H, 03H, 11H, 12H
40096	03 06 16	R W W	Instrument name 11, 12	ASCII 2 characters, Shift JIS 1 character Error code: 01H, 02H, 03H, 11H, 12H
40097	03 06 16	R W W	Instrument name 13, 14	ASCII 2 characters, Shift JIS 1 character Error code: 01H, 02H, 03H, 11H, 12H
40098	03 06 16	R W W	Instrument name 15, 16	ASCII 2 characters, Shift JIS 1 character Error code: 01H, 02H, 03H, 11H, 12H

8-4-2 Setting parameters for each channel

*Writing of multiple setting values across channels becomes an error. (Error code 12H)

R/W ... R: READ, W: WRITE

Reference number	Applied function code	R/W	Content	Detail
40102	03 06 16	R W W	CH1 range number	ASCII code 2 digits (A space code can be used in the first digit.) CH1 to input points: 01(13.80mV) to 80(Pt-Co) If low order communication is registered, same as range number of connected instrument, otherwise 10 (-10.00 to 10.00V) fixed For the optional DI added Contact input channel: 90 (DI) to 92 (pulse (-)) Error code: 01H, 02H, 03H, 09H, 11H, 12H
40103	03 06 16	R W W	CH1 RJ	0: External, 1: Internal * For other than thermocouple inputs "0: External" fixed Error code: 01H, 02H, 03H, 09H, 11H, 12H
40104	03 06 16	R W W	CH1 range low limit	-30000 to 30000 Error code: 01H, 02H, 03H, 09H, 11H, 12H
40105	03 06 16	R W W	CH1 range high limit	-30000 to 30000 Error code: 01H, 02H, 03H, 09H, 11H, 12H
40106	03 06 16	R W W	CH1 range decimal point	Range decimal place 0 to 3 *Same decimal place for range high/low limits values Error code: 01H, 02H, 03H, 09H, 11H, 12H
40107	03 06 16	R W W	CH1 scale low limit	-30000 to 30000 Error code: 01H, 02H, 03H, 09H, 11H, 12H
40108	03 06 16	R W W	CH1 scale high limit	-30000 to 30000 Error code: 01H, 02H, 03H, 09H, 11H, 12H
40109	03 06 16	R W W	CH1 scale decimal point	Scale decimal place 0 to 3 *Same decimal place for scale high/low limits values Error code: 01H, 02H, 03H, 09H, 11H, 12H
40110	03 06 16	R W W	CH1 burnout	0: Disable 1: Up scale, 2: Down scale Error code: 01H, 02H, 03H, 09H, 11H, 12H
40111	03 06 16	R W W	CH1 sensor correction	-30000 to 30000 * The scale decimal point is used for the decimal place. Error code: 01H, 02H, 03H, 09H, 11H, 12H
40112	03 06 16	R W W	CH1 display color	12 colors Error code: 01H, 02H, 03H, 09H, 11H, 12H

Reference number	Applied function code	R/W	Content	Detail
40113	03 06 16	R W W	CH1 filter level	0: System setting is used 1: [0]none, [1]Weak, [2]Middle,[3]Strong Error code: 01H, 02H, 03H, 09H, 11H, 12H
40114	03 06 16	R W W	CH1 alarm marker 1,2	Higher 1 byte: Alarm marker1 0 to 50 Lower 1 byte: Alarm marker2 0 to 50 Error code: 01H, 02H, 03H, 09H, 11H, 12H
40115	03 06 16	R W W	CH1 alarm marker 3,4	Higher 1 byte: Alarm marker3 0 to 50 Lower 1 byte: Alarm marker4 0 to 50 Error code: 01H, 02H, 03H, 09H, 11H, 12H
40116	03 06 16	R W W	CH1 totalizer automatic reset reset by DI	Higher 1 byte: totalizer reset [0]OFF, [1]ON Lower 1 byte; reset by DI 0 to 8 ([0] is none.) Error code: 01H, 02H, 03H, 09H, 11H, 12H
40117	03 06 16	R W W	CH1 totalizer reset reference hour/minute	Higher 1 byte: hour 0 to 23 Lower 1 byte: minute 0 to 59 Error code: 01H, 02H, 03H, 09H, 11H, 12H
40118	03 06 16	R W W	CH1 totalizer reset interval	Higher 1 byte: hour 0 to 24 Lower 1 byte: minute 0 to 59 Error code: 01H, 02H, 03H, 09H, 11H, 12H
40119	03 06 16	R W W	CH1 unit 1, 2	ASCII, Shift JIS 2 digit Error code: 01H, 02H, 03H, 09H, 11H, 12H
40120	03 06 16	R W W	CH1 unit 3, 4	ASCII, Shift JIS 2 digit Error code: 01H, 02H, 03H, 09H, 11H, 12H
40121	03 06 16	R W W	CH1 unit 5, 6	ASCII, Shift JIS 2 digit Error code: 01H, 02H, 03H, 09H, 11H, 12H
40122	03 06 16	R W W	CH1 unit 7	ASCII 1 digit, Low 1 byte - 00H fixed Error code: 01H, 02H, 03H, 09H, 11H, 12H
40125	03 06 16	R W W	CH1 tag 1, 2	ASCII, Shift JIS 2 digit Error code: 01H, 02H, 03H, 09H, 11H, 12H
40126	03 06 16	R W W	CH1 tag 3, 4	ASCII, Shift JIS 2 digit Error code: 01H, 02H, 03H, 09H, 11H, 12H
40127	03 06 16	R W W	CH1 tag 5, 6	ASCII, Shift JIS 2 digit Error code: 01H, 02H, 03H, 09H, 11H, 12H
40128	03 06 16	R W W	CH1 tag 7, 8	ASCII, Shift JIS 2 digit Error code: 01H, 02H, 03H, 09H, 11H, 12H
40129	03 06 16	R W W	CH1 tag 9, 10	ASCII, Shift JIS 2 digit Error code: 01H, 02H, 03H, 09H, 11H, 12H
40130	03 06 16	R W W	CH1 tag 11, 12	ASCII, Shift JIS 2 digit Error code: 01H, 02H, 03H, 09H, 11H, 12H

Reference number	Applied function code	R/W	Content	Detail
40131	03 06 16	R W W	CH1 tag 13, 14	ASCII, Shift JIS 2 digit Error code: 01H, 02H, 03H, 09H, 11H, 12H
40132	03 06 16	R W W	CH1 tag 15	ASCII 1 digit, Low 1 byte - 00H fixed Error code: 01H, 02H, 03H, 09H, 11H, 12H
40133	03 06 16	R W W	CH1 alarm type 1	0: Disable, 1: High limit, 2: Low limit, 5: Difference high limit, 6: Difference low limit, 7: Abnormal data Error code: 01H, 02H, 03H, 09H, 11H, 12H
40134	03 06 16	R W W	CH1 setting value 1	-30000 to 30000 * The scale decimal point is used for the decimal place. Error code: 01H, 02H, 03H, 09H, 11H, 12H
40135	03 06 16	R W W	CH1 output relay 1	ASCII 2 digits 01 to Alarm output point, 00H: No setting Error code: 01H, 02H, 03H, 09H, 11H, 12H
40136	03 06 16	R W W	CH1 AND/OR 1	0: OR, 1: AND Error code: 01H, 02H, 03H, 09H, 11H, 12H
40137	03 06 16	R W W	CH1 reference channel 1	ASCII 2 digits Reference channel No. at differential alarm 3031H(1),3032H(2),3033H(3),.....,3938H(98),3939H(99),3A30H(100),3A31H(101),.....,3B37H(127),3B38H(128) Error code: 01H,02H,03H, 09H,11H,12H
40139	03 06 16	R W W	CH1 dead band 1	0 to 30000 * The scale decimal point is used for the decimal place. Error code: 01H, 02H, 03H, 09H, 11H, 12H
40140	03 06 16	R W W	CH1 alarm delay 1	0 to 3600 seconds Error code: 01H, 02H, 03H, 09H, 11H, 12H
40141	03 06 16	R W W	CH1 alarm type 2	0: Disable, 1: high limit, 2: Low limit, 5: Difference high limit, 6: Difference low limit, 7: Abnormal data Error code: 01H, 02H, 03H, 09H, 11H, 12H
40142	03 06 16	R W W	CH1 setting value 2	-30000 to 30000 * The scale decimal point is used for the decimal place. Error code: 01H, 02H, 03H, 09H, 11H, 12H
40143	03 06 16	R W W	CH1 output relay 2	ASCII 2 digits 01 to Alarm output point, 00H: No setting Error code: 01H, 02H, 03H, 09H, 11H, 12H
40144	03 06 16	R W W	CH1 AND/OR 2	0:OR, 1: AND Error code: 01H, 02H, 03H, 09H, 11H, 12H

Reference number	Applied function code	R/W	Content	Detail
40145	03 06 16	R W W	CH1 reference channel 2	ASCII 2 digits Reference channel No. at differential alarm 3031H(1),3032H(2),3033H(3),.....,3938H(98),3939H(99),3A30H(100),3A31H(101),.....,3B37H(127),3B38H(128) Error code: 01H,02H,03H, 09H,11H,12H
40147	03 06 16	R W W	CH1 dead band 2	0 to 30000 * The scale decimal point is used for the decimal place. Error code: 01H, 02H, 03H, 09H, 11H, 12H
40148	03 06 16	R W W	CH1 alarm delay 2	0 to 3600 seconds Error code: 01H, 02H, 03H, 09H, 11H, 12H
40149	03 06 16	R W W	CH1 alarm type 3	0: Disable, 1: high limit, 2: Low limit, 5: Difference high limit, 6: Difference low limit, 7: Abnormal data Error code: 01H, 02H, 03H, 09H, 11H, 12H
40150	03 06 16	R W W	CH1 setting value 3	-30000 to 30000 * The scale decimal point is used for the decimal place. Error code: 01H, 02H, 03H, 09H, 11H, 12H
40151	03 06 16	R W W	CH1 output relay 3	ASCII 2 digits 01 to Alarm output point, 00H: No setting Error code: 01H, 02H, 03H, 09H, 11H, 12H
40152	03 06 16	R W W	CH1 AND/OR 3	0:OR, 1: AND Error code: 01H, 02H, 03H, 09H, 11H, 12H
40153	03 06 16	R W W	CH1 reference channel 3	ASCII 2 digits Reference channel No. at differential alarm 3031H(1),3032H(2),3033H(3),.....,3938H(98),3939H(99),3A30H(100),3A31H(101),.....,3B37H(127),3B38H(128) Error code: 01H,02H,03H, 09H,11H,12H
40155	03 06 16	R W W	CH1 dead band 3	0 to 30000 * The scale decimal point is used for the decimal place. Error code: 01H, 02H, 03H, 09H, 11H, 12H
40156	03 06 16	R W W	CH1 alarm delay 3	0 to 3600 seconds Error code: 01H, 02H, 03H, 09H, 11H, 12H
40157	03 06 16	R W W	CH1 alarm type 4	0: Disable, 1: high limit, 2: Low limit, 5: Difference high limit, 6: Difference low limit, 7: Abnormal data Error code: 01H, 02H, 03H, 09H, 11H, 12H
40158	03 06 16	R W W	CH1 setting value 4	-30000 to 30000 * The scale decimal point is used for the decimal place. Error code: 01H, 02H, 03H, 09H, 11H, 12H
40159	03 06 16	R W W	CH1 output relay 4	ASCII 2 digits 01 to Alarm output point, 00H: No setting Error code: 01H, 02H, 03H, 09H, 11H, 12H

Reference number	Applied function code	R/W	Content	Detail
40160	03 06 16	R W W	CH1 AND/OR 4	0:OR, 1: AND Error code: 01H, 02H, 03H, 09H, 11H, 12H
40161	03 06 16	R W W	CH1 reference channel 4	ASCII 2 digits Reference channel No. at differential alarm 3031H(1),3032H(2),3033H(3),.....,3938H(98),3939H(99),3A30H(100),3A31H(101),.....,3B37H(127),3B38H(128) Error code: 01H,02H,03H, 09H,11H,12H
40163	03 06 16	R W W	CH1 dead band 4	0 to 30000 * The scale decimal point is used for the decimal place. Error code: 01H, 02H, 03H, 09H, 11H, 12H
40164	03 06 16	R W W	CH1 alarm delay 4	0 to 3600 seconds Error code: 01H, 02H, 03H, 09H, 11H, 12H
40166	03 06 16	R W W	CH1 display scale low limit	-30000 to 30000 Error code: 01H, 02H, 03H, 09H, 11H, 12H
40167	03 06 16	R W W	CH1 display scale high limit	-30000 to 30000 Error code: 01H, 02H, 03H, 09H, 11H, 12H
40168	03 06 16	R W W	CH1 display scale decimal point	0 to 3 Error code: 01H, 02H, 03H, 09H, 11H, 12H
40169	03 06 16	R W W	CH1 display scale type	0: Standard, 1: Exponent Error code: 01H, 02H, 03H, 09H, 11H, 12H
40171	03 06 16	R W W	CH1 range position (Area belonged)	0 to 3, At parallel scale 0 to 7 (0 to 3: First zone, 4 to 7: Second zone) Error code: 01H, 02H, 03H, 09H, 11H, 12H
40176	03 06 16	R W W	Calculation ON/OFF	0: Not used, 1: Used Error code: 01H, 02H, 03H, 09H, 11H, 12H
40177	03 06 16	R W W	CH1 calculation formula 1, 2	ASCII 2 digits Error code: 01H, 02H, 03H, 09H, 11H, 12H
40178	03 06 16	R W W	CH1 calculation formula 3, 4	ASCII 2 digits Error code: 01H, 02H, 03H, 09H, 11H, 12H
40179	03 06 16	R W W	CH1 calculation formula 5, 6	ASCII 2 digits Error code: 01H, 02H, 03H, 09H, 11H, 12H
40180	03 06 16	R W W	CH1 calculation formula 7, 8	ASCII 2 digits Error code: 01H, 02H, 03H, 09H, 11H, 12H
40181	03 06 16	R W W	CH1 calculation formula 9, 10	ASCII 2 digits Error code: 01H, 02H, 03H, 09H, 11H, 12H

Reference number	Applied function code	R/W	Content	Detail
40182	03 06 16	R W W	CH1 calculation formula 11, 12	ASCII 2 digits Error code: 01H, 02H, 03H, 09H, 11H, 12H
40183	03 06 16	R W W	CH1 calculation formula 13, 14	ASCII 2 digits Error code: 01H, 02H, 03H, 09H, 11H, 12H
40184	03 06 16	R W W	CH1 calculation formula 15, 16	ASCII 2 digits Error code: 01H, 02H, 03H, 09H, 11H, 12H
40185	03 06 16	R W W	CH1 calculation formula 17, 18	ASCII 2 digits Error code: 01H, 02H, 03H, 09H, 11H, 12H
40186	03 06 16	R W W	CH1 calculation formula 19, 20	ASCII 2 digits Error code: 01H, 02H, 03H, 09H, 11H, 12H
40187	03 06 16	R W W	CH1 calculation formula 21, 22	ASCII 2 digits Error code: 01H, 02H, 03H, 09H, 11H, 12H
40188	03 06 16	R W W	CH1 calculation formula 23, 24	ASCII 2 digits Error code: 01H, 02H, 03H, 09H, 11H, 12H
40189	03 06 16	R W W	CH1 calculation formula 25, 26	ASCII 2 digits Error code: 01H, 02H, 03H, 09H, 11H, 12H
40190	03 06 16	R W W	CH1 calculation formula 27, 28	ASCII 2 digits Error code: 01H, 02H, 03H, 09H, 11H, 12H
40191	03 06 16	R W W	CH1 calculation formula 29, 30	ASCII 2 digits Error code: 01H, 02H, 03H, 09H, 11H, 12H
40192	03 06 16	R W W	CH1 calculation formula 31, 32	ASCII 2 digits Error code: 01H, 02H, 03H, 09H, 11H, 12H
40193	03 06 16	R W W	CH1 calculation formula 33, 34	ASCII 2 digits Error code: 01H, 02H, 03H, 09H, 11H, 12H
40194	03 06 16	R W W	CH1 calculation formula 35, 36	ASCII 2 digits Error code: 01H, 02H, 03H, 09H, 11H, 12H
40195	03 06 16	R W W	CH1 calculation formula 37, 38	ASCII 2 digits Error code: 01H, 02H, 03H, 09H, 11H, 12H
40196	03 06 16	R W W	CH1 calculation formula 39, 40	ASCII 2 digits Error code: 01H, 02H, 03H, 09H, 11H, 12H
40197	03 06 16	R W W	CH1 calculation formula 41, 42	ASCII 2 digits Error code: 01H, 02H, 03H, 09H, 11H, 12H

Reference number	Applied function code	R/W	Content	Detail
40198	03 06 16	R W W	CH1 calculation formula 43, 44	ASCII 2 digits Error code: 01H, 02H, 03H, 09H, 11H, 12H
40199	03 06 16	R W W	CH1 calculation formula 45, 46	ASCII 2 digits Error code: 01H, 02H, 03H, 09H, 11H, 12H
40200	03 06 16	R W W	CH1 calculation formula 47, 48	ASCII 2 digits Error code: 01H, 02H, 03H, 09H, 11H, 12H
40202 to 40300	03 06 16	R W W	CH2 setting parameter	Same as CH1 parameter (40102 to 40200)
40302 to 40400	03 06 16	R W W	CH3 setting parameter	Same as CH1 parameter (40102 to 40200)
40402 to 40500	03 06 16	R W W	CH4 setting parameter	Same as CH1 parameter (40102 to 40200)
40502 to 40600	03 06 16	R W W	CH5 setting parameter	Same as CH1 parameter (40102 to 40200)
40602 to 40700	03 06 16	R W W	CH6 setting parameter	Same as CH1 parameter (40102 to 40200)
40702 to 40800	03 06 16	R W W	CH7 setting parameter	Same as CH1 parameter (40102 to 40200)
40802 to 40900	03 06 16	R W W	CH8 setting parameter	Same as CH1 parameter (40102 to 40200)
40902 to 41000	03 06 16	R W W	CH9 setting parameter	Same as CH1 parameter (40102 to 40200)
41002 to 41100	03 06 16	R W W	CH10 setting parameter	Same as CH1 parameter (40102 to 40200)
41102 to 41200	03 06 16	R W W	CH11 setting parameter	Same as CH1 parameter (40102 to 40200)
41202 to 41300	03 06 16	R W W	CH12 setting parameter	Same as CH1 parameter (40102 to 40200)
41302 to 41400	03 06 16	R W W	CH13 setting parameter	Same as CH1 parameter (40102 to 40200)
41402 to 41500	03 06 16	R W W	CH14 setting parameter	Same as CH1 parameter (40102 to 40200)

Reference number	Applied function code	R/W	Content	Detail
41502 to 41600	03 06 16	R W W	CH15 setting parameter	Same as CH1 parameter (40102 to 40200)
41602 to 41700	03 06 16	R W W	CH16 setting parameter	Same as CH1 parameter (40102 to 40200)
41702 to 41800	03 06 16	R W W	CH17 setting parameter	Same as CH1 parameter (40102 to 40200)
41802 to 41900	03 06 16	R W W	CH18 setting parameter	Same as CH1 parameter (40102 to 40200)
41902 to 42000	03 06 16	R W W	CH19 setting parameter	Same as CH1 parameter (40102 to 40200)
42002 to 42100	03 06 16	R W W	CH20 setting parameter	Same as CH1 parameter (40102 to 40200)
42102 to 42200	03 06 16	R W W	CH21 setting parameter	Same as CH1 parameter (40102 to 40200)
42202 to 42300	03 06 16	R W W	CH22 setting parameter	Same as CH1 parameter (40102 to 40200)
42302 to 42400	03 06 16	R W W	CH23 setting parameter	Same as CH1 parameter (40102 to 40200)
42402 to 42500	03 06 16	R W W	CH24 setting parameter	Same as CH1 parameter (40102 to 40200)
42502 to 42600	03 06 16	R W W	CH25 setting parameter	Same as CH1 parameter (40102 to 40200)
42602 to 42700	03 06 16	R W W	CH26 setting parameter	Same as CH1 parameter (40102 to 40200)
42702 to 42800	03 06 16	R W W	CH27 setting parameter	Same as CH1 parameter (40102 to 40200)
42802 to 42900	03 06 16	R W W	CH28 setting parameter	Same as CH1 parameter (40102 to 40200)
42902 to 43000	03 06 16	R W W	CH29 setting parameter	Same as CH1 parameter (40102 to 40200)

Reference number	Applied function code	R/W	Content	Detail
43002 to 43100	03 06 16	R W W	CH30 setting parameter	Same as CH1 parameter (40102 to 40200)
43102 to 43200	03 06 16	R W W	CH31 setting parameter	Same as CH1 parameter (40102 to 40200)
43202 to 43300	03 06 16	R W W	CH32 setting parameter	Same as CH1 parameter (40102 to 40200)
43302 to 43400	03 06 16	R W W	CH33 setting parameter	Same as CH1 parameter (40102 to 40200)
43402 to 43500	03 06 16	R W W	CH34 setting parameter	Same as CH1 parameter (40102 to 40200)
43502 to 43600	03 06 16	R W W	CH35 setting parameter	Same as CH1 parameter (40102 to 40200)
43602 to 43700	03 06 16	R W W	CH36 setting parameter	Same as CH1 parameter (40102 to 40200)
43702 to 43800	03 06 16	R W W	CH37 setting parameter	Same as CH1 parameter (40102 to 40200)
43802 to 43900	03 06 16	R W W	CH38 setting parameter	Same as CH1 parameter (40102 to 40200)
43902 to 44000	03 06 16	R W W	CH39 setting parameter	Same as CH1 parameter (40102 to 40200)
44002 to 44100	03 06 16	R W W	CH40 setting parameter	Same as CH1 parameter (40102 to 40200)
44102 to 44200	03 06 16	R W W	CH41 setting parameter	Same as CH1 parameter (40102 to 40200)
44202 to 44300	03 06 16	R W W	CH42 setting parameter	Same as CH1 parameter (40102 to 40200)
44302 to 44400	03 06 16	R W W	CH43 setting parameter	Same as CH1 parameter (40102 to 40200)
44402 to 44500	03 06 16	R W W	CH44 setting parameter	Same as CH1 parameter (40102 to 40200)
44502 to 44600	03 06 16	R W W	CH45 setting parameter	Same as CH1 parameter (40102 to 40200)

Reference number	Applied function code	R/W	Content	Detail
44602 to 44700	03 06 16	R W W	CH46 setting parameter	Same as CH1 parameter (40102 to 40200)
44702 to 44800	03 06 16	R W W	CH47 setting parameter	Same as CH1 parameter (40102 to 40200)
44802 to 44900	03 06 16	R W W	CH48 setting parameter	Same as CH1 parameter (40102 to 40200)
44902 to 45000	03 06 16	R W W	CH49 setting parameter	Same as CH1 parameter (40102 to 40200)

8-4-3 Communications parameter

R/W ... R: READ, W: WRITE

Reference number	Applied function code	R/W	Content	Detail
45001	03	R	IP address 1, 2	IP address
	06	W		Error code: 01H, 02H, 03H, 09H, 11H, 12H
	16	W		
45002	03	R	IP address 3, 4	IP address
	06	W		Error code: 01H, 02H, 03H, 09H, 11H, 12H
	16	W		
45003	03	R	Subnet mask1, 2	Subnet mask
	06	W		Error code: 01H, 02H, 03H, 09H, 11H, 12H
	16	W		
45004	03	R	Subnet mask 3, 4	Subnet mask
	06	W		Error code: 01H, 02H, 03H, 09H, 11H, 12H
	16	W		
45005	03	R	Default gateway 1, 2	Default gateway
	06	W		Error code: 01H, 02H, 03H, 09H, 11H, 12H
	16	W		
45006	03	R	Default gateway 3, 4	Default gateway
	06	W		Error code: 01H, 02H, 03H, 09H, 11H, 12H
	16	W		
45010	03	R	FTP client directory 1, 2	ASCII 2 digits
	06	W		Error code: 01H, 02H, 03H, 09H, 11H, 12H
	16	W		
45011	03	R	FTP client directory 3, 4	ASCII 2 digits
	06	W		Error code: 01H, 02H, 03H, 09H, 11H, 12H
	16	W		
45012	03	R	FTP client directory 5, 6	ASCII 2 digits
	06	W		Error code: 01H, 02H, 03H, 09H, 11H, 12H
	16	W		
45013	03	R	FTP client directory 7, 8	ASCII 2 digits
	06	W		Error code: 01H, 02H, 03H, 09H, 11H, 12H
	16	W		
45014	03	R	FTP client directory 9, 10	ASCII 2 digits
	06	W		Error code: 01H, 02H, 03H, 09H, 11H, 12H
	16	W		
45015	03	R	FTP client directory 11, 12	ASCII 2 digits
	06	W		Error code: 01H, 02H, 03H, 09H, 11H, 12H
	16	W		
45016	03	R	FTP client directory 13, 14	ASCII 2 digits
	06	W		Error code: 01H, 02H, 03H, 09H, 11H, 12H
	16	W		
45017	03	R	FTP client directory 15, 16	ASCII 2 digits
	06	W		Error code: 01H, 02H, 03H, 09H, 11H, 12H
	16	W		
45018	03	R	FTP client directory 17, 18	ASCII 2 digits
	06	W		Error code: 01H, 02H, 03H, 09H, 11H, 12H
	16	W		

Reference number	Applied function code	R/W	Content	Detail
45019	03	R	FTP client directory 19, 20	ASCII 2 digits
	06	W		Error code: 01H, 02H, 03H, 09H, 11H, 12H
	16	W		
45020	03	R	FTP client directory 21, 22	ASCII 2 digits
	06	W		Error code: 01H, 02H, 03H, 09H, 11H, 12H
	16	W		
45021	03	R	FTP client directory 23, 24	ASCII 2 digits
	06	W		Error code: 01H, 02H, 03H, 09H, 11H, 12H
	16	W		
45022	03	R	FTP client directory 25, 26	ASCII 2 digits
	06	W		Error code: 01H, 02H, 03H, 09H, 11H, 12H
	16	W		
45023	03	R	FTP client directory 27, 28	ASCII 2 digits
	06	W		Error code: 01H, 02H, 03H, 09H, 11H, 12H
	16	W		
45024	03	R	FTP client directory 29, 30	ASCII 2 digits
	06	W		Error code: 01H, 02H, 03H, 09H, 11H, 12H
	16	W		
45025	03	R	FTP client directory 31, 32	ASCII 2 digits
	06	W		Error code: 01H, 02H, 03H, 09H, 11H, 12H
	16	W		
45026	03	R	FTP Login user name(client/server) 1, 2	ASCII 2 digits
	06	W		Error code: 01H, 02H, 03H, 09H, 11H, 12H
	16	W		
45027	03	R	FTP Login user name(client/server) 3, 4	ASCII 2 digits
	06	W		Error code: 01H, 02H, 03H, 09H, 11H, 12H
	16	W		
45028	03	R	FTP Login user name(client/server) 5, 6	ASCII 2 digits
	06	W		Error code: 01H, 02H, 03H, 09H, 11H, 12H
	16	W		
45029	03	R	FTP Login user name(client/server) 7, 8	ASCII 2 digits
	06	W		Error code: 01H, 02H, 03H, 09H, 11H, 12H
	16	W		
45030	03	R	FTP Login user name(client/server) 9, 10	ASCII 2 digits
	06	W		Error code: 01H, 02H, 03H, 09H, 11H, 12H
	16	W		
45031	03	R	FTP Login user name(client/server) 11, 12	ASCII 2 digits
	06	W		Error code: 01H, 02H, 03H, 09H, 11H, 12H
	16	W		
45032	03	R	FTP Login user name(client/server) 13, 14	ASCII 2 digits
	06	W		Error code: 01H, 02H, 03H, 09H, 11H, 12H
	16	W		
45033	03	R	FTP Login user name(client/server) 15, 16	ASCII 2 digits
	06	W		Error code: 01H, 02H, 03H, 09H, 11H, 12H
	16	W		
45034	03	R	FTP Login user name(client/server) 17, 18	ASCII 2 digits
	06	W		Error code: 01H, 02H, 03H, 09H, 11H, 12H
	16	W		

Reference number	Applied function code	R/W	Content	Detail
45035	03	R	FTP Login user name(client/server) 19, 20	ASCII 2 digits
	06	W		Error code: 01H, 02H, 03H, 09H, 11H, 12H
	16	W		
45036	03	R	FTP Login user name(client/server) 21, 22	ASCII 2 digits
	06	W		Error code: 01H, 02H, 03H, 09H, 11H, 12H
	16	W		
45037	03	R	FTP Login user name(client/server) 23, 24	ASCII 2 digits
	06	W		Error code: 01H, 02H, 03H, 09H, 11H, 12H
	16	W		
45038	03	R	FTP Login user name(client/server) 25, 26	ASCII 2 digits
	06	W		Error code: 01H, 02H, 03H, 09H, 11H, 12H
	16	W		
45039	03	R	FTP Login user name(client/server) 27, 28	ASCII 2 digits
	06	W		Error code: 01H, 02H, 03H, 09H, 11H, 12H
	16	W		
45040	03	R	FTP Login user name(client/server) 29, 30	ASCII 2 digits
	06	W		Error code: 01H, 02H, 03H, 09H, 11H, 12H
	16	W		
45041	03	R	FTP Login user name(client/server) 31, 32	ASCII 2 digits
	06	W		Error code: 01H, 02H, 03H, 09H, 11H, 12H
	16	W		
45042	03	R	FTP Login password (client/server) 1, 2	ASCII 2 digits
	06	W		Error code: 01H, 02H, 03H, 09H, 11H, 12H
	16	W		
45043	03	R	FTP Login password (client/server) 3, 4	ASCII 2 digits
	06	W		Error code: 01H, 02H, 03H, 09H, 11H, 12H
	16	W		
45044	03	R	FTP Login password (client/server) 5, 6	ASCII 2 digits
	06	W		Error code: 01H, 02H, 03H, 09H, 11H, 12H
	16	W		
45045	03	R	FTP Login password (client/server) 7, 8	ASCII 2 digits
	06	W		Error code: 01H, 02H, 03H, 09H, 11H, 12H
	16	W		
45046	03	R	FTP Login password (client/server) 9, 10	ASCII 2 digits
	06	W		Error code: 01H, 02H, 03H, 09H, 11H, 12H
	16	W		
45047	03	R	FTP Login password (client/server) 11, 12	ASCII 2 digits
	06	W		Error code: 01H, 02H, 03H, 09H, 11H, 12H
	16	W		
45048	03	R	FTP Login password (client/server) 13, 14	ASCII 2 digits
	06	W		Error code: 01H, 02H, 03H, 09H, 11H, 12H
	16	W		
45049	03	R	FTP Login password (client/server) 15, 16	ASCII 2 digits
	06	W		Error code: 01H, 02H, 03H, 09H, 11H, 12H
	16	W		
45050	03	R	FTP Login password (client/server) 17, 18	ASCII 2 digits
	06	W		Error code: 01H, 02H, 03H, 09H, 11H, 12H
	16	W		

Reference number	Applied function code	R/W	Content	Detail
45051	03	R	FTP Login password (client/server) 19, 20	ASCII 2 digits
	06	W		Error code: 01H, 02H, 03H, 09H, 11H,
	16	W		12H
45052	03	R	FTP Login password (client/server) 21, 22	ASCII 2 digits
	06	W		Error code: 01H, 02H, 03H, 09H, 11H,
	16	W		12H
45053	03	R	FTP Login password (client/server) 23, 24	ASCII 2 digits
	06	W		Error code: 01H, 02H, 03H, 09H, 11H,
	16	W		12H
45054	03	R	FTP Login password (client/server) 25, 26	ASCII 2 digits
	06	W		Error code: 01H, 02H, 03H, 09H, 11H,
	16	W		12H
45055	03	R	FTP Login password (client/server) 27, 28	ASCII 2 digits
	06	W		Error code: 01H, 02H, 03H, 09H, 11H,
	16	W		12H
45056	03	R	FTP Login password (client/server) 29, 30	ASCII 2 digits
	06	W		Error code: 01H, 02H, 03H, 09H, 11H,
	16	W		12H
45057	03	R	FTP Login password (client/server) 31, 32	ASCII 2 digits
	06	W		Error code: 01H, 02H, 03H, 09H, 11H,
	16	W		12H
45058	03	R	FTP client PASV mode	0:OFF, 1:ON
	06	W		Error code: 01H, 02H, 03H, 09H, 11H,
	16	W		12H
45059	03	R	FTP client Auto transfer	0:OFF, 1:ON
	06	W		Error code: 01H, 02H, 03H, 09H, 11H,
	16	W		12H
45060	03	R	FTP client Retry mode	0:OFF, 1:ON
	06	W		Error code: 01H, 02H, 03H, 09H, 11H,
	16	W		12H
45070	03	R	FTP server ON/OFF	0:OFF, 1:ON
	06	W		Error code: 01H, 02H, 03H, 09H, 11H,
	16	W		12H
45071	03	R	FTP server address 1, 2	ASCII 2 digits
	06	W		Error code: 01H, 02H, 03H, 09H, 11H,
	16	W		12H
45072	03	R	FTP server address 3, 4	ASCII 2 digits
	06	W		Error code: 01H, 02H, 03H, 09H, 11H,
	16	W		12H
45073	03	R	FTP server address 5, 6	ASCII 2 digits
	06	W		Error code: 01H, 02H, 03H, 09H, 11H,
	16	W		12H
45074	03	R	FTP server address 7, 8	ASCII 2 digits
	06	W		Error code: 01H, 02H, 03H, 09H, 11H,
	16	W		12H
45075	03	R	FTP server address 9, 10	ASCII 2 digits
	06	W		Error code: 01H, 02H, 03H, 09H, 11H,
	16	W		12H

Reference number	Applied function code	R/W	Content	Detail
45076	03	R	FTP server address 11, 12	ASCII 2 digits
	06	W		Error code: 01H, 02H, 03H, 09H, 11H, 12H
	16	W		
45077	03	R	FTP server address 13, 14	ASCII 2 digits
	06	W		Error code: 01H, 02H, 03H, 09H, 11H, 12H
	16	W		
45078	03	R	FTP server address 15, 16	ASCII 2 digits
	06	W		Error code: 01H, 02H, 03H, 09H, 11H, 12H
	16	W		
45079	03	R	FTP server address 17, 18	ASCII 2 digits
	06	W		Error code: 01H, 02H, 03H, 09H, 11H, 12H
	16	W		
45080	03	R	FTP server address 19, 20	ASCII 2 digits
	06	W		Error code: 01H, 02H, 03H, 09H, 11H, 12H
	16	W		
45081	03	R	FTP server address 21, 22	ASCII 2 digits
	06	W		Error code: 01H, 02H, 03H, 09H, 11H, 12H
	16	W		
45082	03	R	FTP server address 23, 24	ASCII 2 digits
	06	W		Error code: 01H, 02H, 03H, 09H, 11H, 12H
	16	W		
45083	03	R	FTP server address 25, 26	ASCII 2 digits
	06	W		Error code: 01H, 02H, 03H, 09H, 11H, 12H
	16	W		
45084	03	R	FTP server address 27, 28	ASCII 2 digits
	06	W		Error code: 01H, 02H, 03H, 09H, 11H, 12H
	16	W		
45085	03	R	FTP server address 29, 30	ASCII 2 digits
	06	W		Error code: 01H, 02H, 03H, 09H, 11H, 12H
	16	W		
45086	03	R	FTP server address 31, 32	ASCII 2 digits
	06	W		Error code: 01H, 02H, 03H, 09H, 11H, 12H
	16	W		
45091	03	R	Login user name (for server) 1, 2	ASCII 2 digits
	06	W		Error code: 01H, 02H, 03H, 09H, 11H, 12H
	16	W		
45092	03	R	Login user name (for server) 3, 4	ASCII 2 digits
	06	W		Error code: 01H, 02H, 03H, 09H, 11H, 12H
	16	W		
45093	03	R	Login user name (for server) 5, 6	ASCII 2 digits
	06	W		Error code: 01H, 02H, 03H, 09H, 11H, 12H
	16	W		
45094	03	R	Login user name (for server) 7, 8	ASCII 2 digits
	06	W		Error code: 01H, 02H, 03H, 09H, 11H, 12H
	16	W		
45095	03	R	Login user name (for server) 9, 10	ASCII 2 digits
	06	W		Error code: 01H, 02H, 03H, 09H, 11H, 12H
	16	W		

Reference number	Applied function code	R/W	Content	Detail
45096	03 06 16	R W W	Login user name (for server) 11, 12	ASCII 2 digits Error code: 01H, 02H, 03H, 09H, 11H, 12H
45097	03 06 16	R W W	Login user name (for server) 13, 14	ASCII 2 digits Error code: 01H, 02H, 03H, 09H, 11H, 12H
45098	03 06 16	R W W	Login user name (for server) 15, 16	ASCII 2 digits Error code: 01H, 02H, 03H, 09H, 11H, 12H
45099	03 06 16	R W W	Login user name (for server) 17, 18	ASCII 2 digits Error code: 01H, 02H, 03H, 09H, 11H, 12H
45100	03 06 16	R W W	Login user name (for server) 19, 20	ASCII 2 digits Error code: 01H, 02H, 03H, 09H, 11H, 12H
45101	03 06 16	R W W	Login user name (for server) 21, 22	ASCII 2 digits Error code: 01H, 02H, 03H, 09H, 11H, 12H
45102	03 06 16	R W W	Login user name (for server) 23, 24	ASCII 2 digits Error code: 01H, 02H, 03H, 09H, 11H, 12H
45103	03 06 16	R W W	Login user name (for server) 25, 26	ASCII 2 digits Error code: 01H, 02H, 03H, 09H, 11H, 12H
45104	03 06 16	R W W	Login user name (for server) 27, 28	ASCII 2 digits Error code: 01H, 02H, 03H, 09H, 11H, 12H
45105	03 06 16	R W W	Login user name (for server) 29,30	ASCII 2 digits Error code: 01H, 02H, 03H, 09H, 11H, 12H
45106	03 06 16	R W W	Login user name (for server) 31, 32	ASCII 2 digits Error code: 01H, 02H, 03H, 09H, 11H, 12H
45111	03 06 16	R W W	Login password (for server) 1, 2	ASCII 2 digits Error code: 01H, 02H, 03H, 09H, 11H, 12H
45112	03 06 16	R W W	Login password (for server) 3, 4	ASCII 2 digits Error code: 01H, 02H, 03H, 09H, 11H, 12H
45113	03 06 16	R W W	Login password (for server) 5, 6	ASCII 2 digits Error code: 01H, 02H, 03H, 09H, 11H, 12H
45114	03 06 16	R W W	Login password (for server) 7, 8	ASCII 2 digits Error code: 01H, 02H, 03H, 09H, 11H, 12H
45115	03 06 16	R W W	Login password (for server) 9, 10	ASCII 2 digits Error code: 01H, 02H, 03H, 09H, 11H, 12H

Reference number	Applied function code	R/W	Content	Detail
45116	03 06 16	R W W	Login password (for server) 11, 12	ASCII 2 digits Error code: 01H, 02H, 03H, 09H, 11H, 12H
45117	03 06 16	R W W	Login password (for server) 13, 14	ASCII 2 digits Error code: 01H, 02H, 03H, 09H, 11H, 12H
45118	03 06 16	R W W	Login password (for server) 15, 16	ASCII 2 digits Error code: 01H, 02H, 03H, 09H, 11H, 12H
45119	03 06 16	R W W	Login password (for server) 17, 18	ASCII 2 digits Error code: 01H, 02H, 03H, 09H, 11H, 12H
45120	03 06 16	R W W	Login password (for server) 19, 20	ASCII 2 digits Error code: 01H, 02H, 03H, 09H, 11H, 12H
45121	03 06 16	R W W	Login password (for server) 21, 22	ASCII 2 digits Error code: 01H, 02H, 03H, 09H, 11H, 12H
45122	03 06 16	R W W	Login password (for server) 23, 24	ASCII 2 digits Error code: 01H, 02H, 03H, 09H, 11H, 12H
45123	03 06 16	R W W	Login password (for server) 25, 26	ASCII 2 digits Error code: 01H, 02H, 03H, 09H, 11H, 12H
45124	03 06 16	R W W	Login password (for server) 27,28	ASCII 2 digits Error code: 01H, 02H, 03H, 09H, 11H, 12H
45125	03 06 16	R W W	Login password (for server) 29, 30	ASCII 2 digits Error code: 01H, 02H, 03H, 09H, 11H, 12H
45126	03 06 16	R W W	Login password (for server) 31, 32	ASCII 2 digits Error code: 01H, 02H, 03H, 09H, 11H, 12H
45141	03 06 16	R W W	E-mail transfer condition 1 Condition type selection/Transfer address number	Higher 1 byte Condition type selection 0: Disable, 1: At alarm activated, 2: At fixed time Lower 1 byte Transfer address number: Bit correspondence Bit 0 to 7 → Address 1 to 8
45142	03 06 16	R W W	E-mail transfer condition 1 Alarm channel starting/ending numbers	Higher 1 byte Starting channel number: 1 to number of recording points Lower 1 byte Ending channel number: 1 to number of recording points Error code: 01H, 02H, 03H, 09H, 11H, 12H
45143	03 06 16	R W W	E-mail transfer condition 1 Reference hour/minute	Higher 1 byte At reference: 0 to 23 Lower 1 byte For reference: 0 to 59 00:00 to 23:59 Error code: 01H, 02H, 03H, 09H, 11H, 12H

Reference number	Applied function code	R/W	Content	Detail
45144	03 06 16	R W W	E-mail transfer condition 1 Interval hour/minute	Higher 1 byte At interval: 0 to 24 Lower 1 byte For interval: 0 to 59 00:00 to 24:00 Error code: 01H, 02H, 03H, 09H, 11H, 12H
45145 to 45148	03 06 16	R W W	E-mail transfer condition 2	Same as E-mail transfer condition 1 (45141 to 45144)
45149 to 45152	03 06 16	R W W	E-mail transfer condition 3	Same as E-mail transfer condition 1 (45141 to 45144)
45153 to 45156	03 06 16	R W W	E-mail transfer condition 4	Same as E-mail transfer condition 1 (45141 to 45144)
45157 to 45160	03 06 16	R W W	E-mail transfer condition 5	Same as E-mail transfer condition 1 (45141 to 45144)
45161 to 45164	03 06 16	R W W	E-mail transfer condition 6	Same as E-mail transfer condition 1 (45141 to 45144)
45165 to 45168	03 06 16	R W W	E-mail transfer condition 7	Same as E-mail transfer condition 1 (45141 to 45144)
45169 to 45172	03 06 16	R W W	E-mail transfer condition 8	Same as E-mail transfer condition 1 (45141 to 45144)
45181	03 06 16	R W W	E-mail transfer address 1 1, 2	ASCII 2 digits Error code: 01H, 02H, 03H, 09H, 11H, 12H
45182	03 06 16	R W W	E-mail transfer address 1 3, 4	ASCII 2 digits Error code: 01H, 02H, 03H, 09H, 11H, 12H
45183	03 06 16	R W W	E-mail transfer address 1 5, 6	ASCII 2 digits Error code: 01H, 02H, 03H, 09H, 11H, 12H
45184	03 06 16	R W W	E-mail transfer address 1 7, 8	ASCII 2 digits Error code: 01H, 02H, 03H, 09H, 11H, 12H
45185	03 06 16	R W W	E-mail transfer address 1 9, 10	ASCII 2 digits Error code: 01H, 02H, 03H, 09H, 11H, 12H
45186	03 06 16	R W W	E-mail transfer address 1 11, 12	ASCII 2 digits Error code: 01H, 02H, 03H, 09H, 11H, 12H
45187	03 06 16	R W W	E-mail transfer address 1 13, 14	ASCII 2 digits Error code: 01H, 02H, 03H, 09H, 11H, 12H
45188	03 06 16	R W W	E-mail transfer address 1 15, 16	ASCII 2 digits Error code: 01H, 02H, 03H, 09H, 11H, 12H

Reference number	Applied function code	R/W	Content	Detail
45189	03 06 16	R W W	E-mail transfer address 1 17, 18	ASCII 2 digits Error code: 01H, 02H, 03H, 09H, 11H, 12H
45190	03 06 16	R W W	E-mail transfer address 1 19, 20	ASCII 2 digits Error code: 01H, 02H, 03H, 09H, 11H, 12H
45191	03 06 16	R W W	E-mail transfer address 1 21, 22	ASCII 2 digits Error code: 01H, 02H, 03H, 09H, 11H, 12H
45192	03 06 16	R W W	E-mail transfer address 1 23, 24	ASCII 2 digits Error code: 01H, 02H, 03H, 09H, 11H, 12H
45193	03 06 16	R W W	E-mail transfer address 1 25, 26	ASCII 2 digits Error code: 01H, 02H, 03H, 09H, 11H, 12H
45194	03 06 16	R W W	E-mail transfer address 1 27, 28	ASCII 2 digits Error code: 01H, 02H, 03H, 09H, 11H, 12H
45195	03 06 16	R W W	E-mail transfer address 1 29, 30	ASCII 2 digits Error code: 01H, 02H, 03H, 09H, 11H, 12H
45196	03 06 16	R W W	E-mail transfer address 1 31, 32	ASCII 2 digits Error code: 01H, 02H, 03H, 09H, 11H, 12H
45197 to 45212	03 06 16	R W W	E-mail transfer address 2	Same as E-mail address 1 (45181 to 45196)
45213 to 45228	03 06 16	R W W	E-mail transfer address 3	Same as E-mail address 1 (45181 to 45196)
45229 to 45244	03 06 16	R W W	E-mail transfer address 4	Same as E-mail address 1 (45181 to 45196)
45245 to 45260	03 06 16	R W W	E-mail transfer address 5	Same as E-mail address 1 (45181 to 45196)
45261 to 45276	03 06 16	R W W	E-mail transfer address 6	Same as E-mail address 1 (45181 to 45196)
45277 to 45292	03 06 16	R W W	E-mail transfer address 7	Same as E-mail address 1 (45181 to 45196)
45293 to 45308	03 06 16	R W W	E-mail transfer address 8	Same as E-mail address 1 (45181 to 45196)
45311	03 06 16	R W W	E-mail attached data CH1	Bit correspondence Bit 0: Address 1 to Bit 7: Address 8 0: Not attached, 1: Attached Error code: 01H, 02H, 03H, 09H, 11H, 12H

Reference number	Applied function code	R/W	Content	Detail
45312	03 06 16	R W W	E-mail attached data CH2	Bit correspondence Bit 0: Address 1 to Bit 7: Address 8 0: Not attached, 1: Attached Error code: 01H, 02H, 03H, 09H, 11H, 12H
45313	03 06 16	R W W	E-mail attached data CH3	Bit correspondence Bit 0: Address 1 to Bit 7: Address 8 0: Not attached, 1: Attached Error code: 01H, 02H, 03H, 09H, 11H, 12H
45314	03 06 16	R W W	E-mail attached data CH4	Bit correspondence Bit 0: Address 1 to Bit 7: Address 8 0: Not attached, 1: Attached Error code: 01H, 02H, 03H, 09H, 11H, 12H
45315	03 06 16	R W W	E-mail attached data CH5	Bit correspondence Bit 0: Address 1 to Bit 7: Address 8 0: Not attached, 1: Attached Error code: 01H, 02H, 03H, 09H, 11H, 12H
45316	03 06 16	R W W	E-mail attached data CH6	Bit correspondence Bit 0: Address 1 to Bit 7: Address 8 0: Not attached, 1: Attached Error code: 01H, 02H, 03H, 09H, 11H, 12H
45317	03 06 16	R W W	E-mail attached data CH7	Bit correspondence Bit 0: Address 1 to Bit 7: Address 8 0: Not attached, 1: Attached Error code: 01H, 02H, 03H, 09H, 11H, 12H
45318	03 06 16	R W W	E-mail attached data CH8	Bit correspondence Bit 0: Address 1 to Bit 7: Address 8 0: Not attached, 1: Attached Error code: 01H, 02H, 03H, 09H, 11H, 12H
45319	03 06 16	R W W	E-mail attached data CH9	Bit correspondence Bit 0: Address 1 to Bit 7: Address 8 0: Not attached, 1: Attached Error code: 01H, 02H, 03H, 09H, 11H, 12H
45320	03 06 16	R W W	E-mail attached data CH10	Bit correspondence Bit 0: Address 1 to Bit 7: Address 8 0: Not attached, 1: Attached Error code: 01H, 02H, 03H, 09H, 11H, 12H
45321	03 06 16	R W W	E-mail attached data CH11	Bit correspondence Bit 0: Address 1 to Bit 7: Address 8 0: Not attached, 1: Attached Error code: 01H, 02H, 03H, 09H, 11H, 12H

Reference number	Applied function code	R/W	Content	Detail
45322	03 06 16	R W W	E-mail attached data CH12	Bit correspondence Bit 0: Address 1 to Bit 7: Address 8 0: Not attached, 1: Attached Error code: 01H, 02H, 03H, 09H, 11H, 12H
45323	03 06 16	R W W	E-mail attached data CH13	Bit correspondence Bit 0: Address 1 to Bit 7: Address 8 0: Not attached, 1: Attached Error code: 01H, 02H, 03H, 09H, 11H, 12H
45324	03 06 16	R W W	E-mail attached data CH14	Bit correspondence Bit 0: Address 1 to Bit 7: Address 8 0: Not attached, 1: Attached Error code: 01H, 02H, 03H, 09H, 11H, 12H
45325	03 06 16	R W W	E-mail attached data CH15	Bit correspondence Bit 0: Address 1 to Bit 7: Address 8 0: Not attached, 1: Attached Error code: 01H, 02H, 03H, 09H, 11H, 12H
45326	03 06 16	R W W	E-mail attached data CH16	Bit correspondence Bit 0: Address 1 to Bit 7: Address 8 0: Not attached, 1: Attached Error code: 01H, 02H, 03H, 09H, 11H, 12H
45327	03 06 16	R W W	E-mail attached data CH17	Bit correspondence Bit 0: Address 1 to Bit 7: Address 8 0: Not attached, 1: Attached Error code: 01H, 02H, 03H, 09H, 11H, 12H
45328	03 06 16	R W W	E-mail attached data CH18	Bit correspondence Bit 0: Address 1 to Bit 7: Address 8 0: Not attached, 1: Attached Error code: 01H, 02H, 03H, 09H, 11H, 12H
45329	03 06 16	R W W	E-mail attached data CH19	Bit correspondence Bit 0: Address 1 to Bit 7: Address 8 0: Not attached, 1: Attached Error code: 01H, 02H, 03H, 09H, 11H, 12H
45330	03 06 16	R W W	E-mail attached data CH20	Bit correspondence Bit 0: Address 1 to Bit 7: Address 8 0: Not attached, 1: Attached Error code: 01H, 02H, 03H, 09H, 11H, 12H
45331	03 06 16	R W W	E-mail attached data CH21	Bit correspondence Bit 0: Address 1 to Bit 7: Address 8 0: Not attached, 1: Attached Error code: 01H, 02H, 03H, 09H, 11H, 12H

Reference number	Applied function code	R/W	Content	Detail
45332	03 06 16	R W W	E-mail attached data CH22	Bit correspondence Bit 0: Address 1 to Bit 7: Address 8 0: Not attached, 1: Attached Error code: 01H, 02H, 03H, 09H, 11H, 12H
45333	03 06 16	R W W	E-mail attached data CH23	Bit correspondence Bit 0: Address 1 to Bit 7: Address 8 0: Not attached, 1: Attached Error code: 01H, 02H, 03H, 09H, 11H, 12H
45334	03 06 16	R W W	E-mail attached data CH24	Bit correspondence Bit 0: Address 1 to Bit 7: Address 8 0: Not attached, 1: Attached Error code: 01H, 02H, 03H, 09H, 11H, 12H
45335	03 06 16	R W W	E-mail attached data CH25	Bit correspondence Bit 0: Address 1 to Bit 7: Address 8 0: Not attached, 1: Attached Error code: 01H, 02H, 03H, 09H, 11H, 12H
45336	03 06 16	R W W	E-mail attached data CH26	Bit correspondence Bit 0: Address 1 to Bit 7: Address 8 0: Not attached, 1: Attached Error code: 01H, 02H, 03H, 09H, 11H, 12H
45337	03 06 16	R W W	E-mail attached data CH27	Bit correspondence Bit 0: Address 1 to Bit 7: Address 8 0: Not attached, 1: Attached Error code: 01H, 02H, 03H, 09H, 11H, 12H
45338	03 06 16	R W W	E-mail attached data CH28	Bit correspondence Bit 0: Address 1 to Bit 7: Address 8 0: Not attached, 1: Attached Error code: 01H, 02H, 03H, 09H, 11H, 12H
45339	03 06 16	R W W	E-mail attached data CH29	Bit correspondence Bit 0: Address 1 to Bit 7: Address 8 0: Not attached, 1: Attached Error code: 01H, 02H, 03H, 09H, 11H, 12H
45340	03 06 16	R W W	E-mail attached data CH30	Bit correspondence Bit 0: Address 1 to Bit 7: Address 8 0: Not attached, 1: Attached Error code: 01H, 02H, 03H, 09H, 11H, 12H
45341	03 06 16	R W W	E-mail attached data CH31	Bit correspondence Bit 0: Address 1 to Bit 7: Address 8 0: Not attached, 1: Attached Error code: 01H, 02H, 03H, 09H, 11H, 12H

Reference number	Applied function code	R/W	Content	Detail
45342	03 06 16	R W W	E-mail attached data CH32	Bit correspondence Bit 0: Address 1 to Bit 7: Address 8 0: Not attached, 1: Attached Error code: 01H, 02H, 03H, 09H, 11H, 12H
45343	03 06 16	R W W	E-mail attached data CH33	Bit correspondence Bit 0: Address 1 to Bit 7: Address 8 0: Not attached, 1: Attached Error code: 01H, 02H, 03H, 09H, 11H, 12H
45344	03 06 16	R W W	E-mail attached data CH34	Bit correspondence Bit 0: Address 1 to Bit 7: Address 8 0: Not attached, 1: Attached Error code: 01H, 02H, 03H, 09H, 11H, 12H
45345	03 06 16	R W W	E-mail attached data CH35	Bit correspondence Bit 0: Address 1 to Bit 7: Address 8 0: Not attached, 1: Attached Error code: 01H, 02H, 03H, 09H, 11H, 12H
45346	03 06 16	R W W	E-mail attached data CH36	Bit correspondence Bit 0: Address 1 to Bit 7: Address 8 0: Not attached, 1: Attached Error code: 01H, 02H, 03H, 09H, 11H, 12H
45347	03 06 16	R W W	E-mail attached data CH37	Bit correspondence Bit 0: Address 1 to Bit 7: Address 8 0: Not attached, 1: Attached Error code: 01H, 02H, 03H, 09H, 11H, 12H
45348	03 06 16	R W W	E-mail attached data CH38	Bit correspondence Bit 0: Address 1 to Bit 7: Address 8 0: Not attached, 1: Attached Error code: 01H, 02H, 03H, 09H, 11H, 12H
45349	03 06 16	R W W	E-mail attached data CH39	Bit correspondence Bit 0: Address 1 to Bit 7: Address 8 0: Not attached, 1: Attached Error code: 01H, 02H, 03H, 09H, 11H, 12H
45350	03 06 16	R W W	E-mail attached data CH40	Bit correspondence Bit 0: Address 1 to Bit 7: Address 8 0: Not attached, 1: Attached Error code: 01H, 02H, 03H, 09H, 11H, 12H
45351	03 06 16	R W W	E-mail attached data CH41	Bit correspondence Bit 0: Address 1 to Bit 7: Address 8 0: Not attached, 1: Attached Error code: 01H, 02H, 03H, 09H, 11H, 12H

Reference number	Applied function code	R/W	Content	Detail
45352	03 06 16	R W W	E-mail attached data CH42	Bit correspondence Bit 0: Address 1 to Bit 7: Address 8 0: Not attached, 1: Attached Error code: 01H, 02H, 03H, 09H, 11H, 12H
45353	03 06 16	R W W	E-mail attached data CH43	Bit correspondence Bit 0: Address 1 to Bit 7: Address 8 0: Not attached, 1: Attached Error code: 01H, 02H, 03H, 09H, 11H, 12H
45354	03 06 16	R W W	E-mail attached data CH44	Bit correspondence Bit 0: Address 1 to Bit 7: Address 8 0: Not attached, 1: Attached Error code: 01H, 02H, 03H, 09H, 11H, 12H
45361	03 06 16	R W W	POP3 address 1, 2	ASCII 2 digits Error code: 01H, 02H, 03H, 09H, 11H, 12H
45362	03 06 16	R W W	POP3 address 3, 4	ASCII 2 digits Error code: 01H, 02H, 03H, 09H, 11H, 12H
45363	03 06 16	R W W	POP3 address 5, 6	ASCII 2 digits Error code: 01H, 02H, 03H, 09H, 11H, 12H
45364	03 06 16	R W W	POP3 address 7, 8	ASCII 2 digits Error code: 01H, 02H, 03H, 09H, 11H, 12H
45365	03 06 16	R W W	POP3 address 9, 10	ASCII 2 digits Error code: 01H, 02H, 03H, 09H, 11H, 12H
45366	03 06 16	R W W	POP3 address 11, 12	ASCII 2 digits Error code: 01H, 02H, 03H, 09H, 11H, 12H
45367	03 06 16	R W W	POP3 address 13, 14	ASCII 2 digits Error code: 01H, 02H, 03H, 09H, 11H, 12H
45368	03 06 16	R W W	POP3 address 15, 16	ASCII 2 digits Error code: 01H, 02H, 03H, 09H, 11H, 12H
45369	03 06 16	R W W	POP3 address 17, 18	ASCII 2 digits Error code: 01H, 02H, 03H, 09H, 11H, 12H
45370	03 06 16	R W W	POP3 address 19, 20	ASCII 2 digits Error code: 01H, 02H, 03H, 09H, 11H, 12H
45371	03 06 16	R W W	POP3 address 21, 22	ASCII 2 digits Error code: 01H, 02H, 03H, 09H, 11H, 12H

Reference number	Applied function code	R/W	Content	Detail
45372	03	R	POP3 address 23, 24	ASCII 2 digits
	06	W		Error code: 01H, 02H, 03H, 09H, 11H, 12H
	16	W		
45373	03	R	POP3 address 25, 26	ASCII 2 digits
	06	W		Error code: 01H, 02H, 03H, 09H, 11H, 12H
	16	W		
45374	03	R	POP3 address 27, 28	ASCII 2 digits
	06	W		Error code: 01H, 02H, 03H, 09H, 11H, 12H
	16	W		
45375	03	R	POP3 address 29, 30	ASCII 2 digits
	06	W		Error code: 01H, 02H, 03H, 09H, 11H, 12H
	16	W		
45376	03	R	POP3 address 31, 32	ASCII 2 digits
	06	W		Error code: 01H, 02H, 03H, 09H, 11H, 12H
	16	W		
45381	03	R	SMTP address 1, 2	ASCII 2 digits
	06	W		Error code: 01H, 02H, 03H, 09H, 11H, 12H
	16	W		
45382	03	R	SMTP address 3, 4	ASCII 2 digits
	06	W		Error code: 01H, 02H, 03H, 09H, 11H, 12H
	16	W		
45383	03	R	SMTP address 5, 6	ASCII 2 digits
	06	W		Error code: 01H, 02H, 03H, 09H, 11H, 12H
	16	W		
45384	03	R	SMTP address 7, 8	ASCII 2 digits
	06	W		Error code: 01H, 02H, 03H, 09H, 11H, 12H
	16	W		
45385	03	R	SMTP address 9, 10	ASCII 2 digits
	06	W		Error code: 01H, 02H, 03H, 09H, 11H, 12H
	16	W		
45386	03	R	SMTP address 11, 12	ASCII 2 digits
	06	W		Error code: 01H, 02H, 03H, 09H, 11H, 12H
	16	W		
45387	03	R	SMTP address 13, 14	ASCII 2 digits
	06	W		Error code: 01H, 02H, 03H, 09H, 11H, 12H
	16	W		
45388	03	R	SMTP address 15, 16	ASCII 2 digits
	06	W		Error code: 01H, 02H, 03H, 09H, 11H, 12H
	16	W		
45389	03	R	SMTP address 17, 18	ASCII 2 digits
	06	W		Error code: 01H, 02H, 03H, 09H, 11H, 12H
	16	W		
45390	03	R	SMTP address 19, 20	ASCII 2 digits
	06	W		Error code: 01H, 02H, 03H, 09H, 11H, 12H
	16	W		
45391	03	R	SMTP address 21, 22	ASCII 2 digits
	06	W		Error code: 01H, 02H, 03H, 09H, 11H, 12H
	16	W		

Reference number	Applied function code	R/W	Content	Detail
45392	03	R	SMTP address 23, 24	ASCII 2 digits
	06	W		Error code: 01H, 02H, 03H, 09H, 11H, 12H
	16	W		
45393	03	R	SMTP address 25, 26	ASCII 2 digits
	06	W		Error code: 01H, 02H, 03H, 09H, 11H, 12H
	16	W		
45394	03	R	SMTP address 27, 28	ASCII 2 digits
	06	W		Error code: 01H, 02H, 03H, 09H, 11H, 12H
	16	W		
45395	03	R	SMTP address 29, 30	ASCII 2 digits
	06	W		Error code: 01H, 02H, 03H, 09H, 11H, 12H
	16	W		
45396	03	R	SMTP address 31, 32	ASCII 2 digits
	06	W		Error code: 01H, 02H, 03H, 09H, 11H, 12H
	16	W		
45401	03	R	Sender address 1, 2	ASCII 2 digits
	06	W		Error code: 01H, 02H, 03H, 09H, 11H, 12H
	16	W		
45402	03	R	Sender address 3, 4	ASCII 2 digits
	06	W		Error code: 01H, 02H, 03H, 09H, 11H, 12H
	16	W		
45403	03	R	Sender address 5, 6	ASCII 2 digits
	06	W		Error code: 01H, 02H, 03H, 09H, 11H, 12H
	16	W		
45404	03	R	Sender address 7, 8	ASCII 2 digits
	06	W		Error code: 01H, 02H, 03H, 09H, 11H, 12H
	16	W		
45405	03	R	Sender address 9, 10	ASCII 2 digits
	06	W		Error code: 01H, 02H, 03H, 09H, 11H, 12H
	16	W		
45406	03	R	Sender address 11, 12	ASCII 2 digits
	06	W		Error code: 01H, 02H, 03H, 09H, 11H, 12H
	16	W		
45407	03	R	Sender address 13, 14	ASCII 2 digits
	06	W		Error code: 01H, 02H, 03H, 09H, 11H, 12H
	16	W		
45408	03	R	Sender address 15, 16	ASCII 2 digits
	06	W		Error code: 01H, 02H, 03H, 09H, 11H, 12H
	16	W		
45409	03	R	Sender address 17, 18	ASCII 2 digits
	06	W		Error code: 01H, 02H, 03H, 09H, 11H, 12H
	16	W		
45410	03	R	Sender address 19, 20	ASCII 2 digits
	06	W		Error code: 01H, 02H, 03H, 09H, 11H, 12H
	16	W		
45411	03	R	Sender address 21, 22	ASCII 2 digits
	06	W		Error code: 01H, 02H, 03H, 09H, 11H, 12H
	16	W		

Reference number	Applied function code	R/W	Content	Detail
45412	03	R	Sender address 23, 24	ASCII 2 digits Error code: 01H, 02H, 03H, 09H, 11H, 12H
	06	W		
	16	W		
45413	03	R	Sender address 25, 26	ASCII 2 digits Error code: 01H, 02H, 03H, 09H, 11H, 12H
	06	W		
	16	W		
45414	03	R	Sender address 27, 28	ASCII 2 digits Error code: 01H, 02H, 03H, 09H, 11H, 12H
	06	W		
	16	W		
45415	03	R	Sender address 29, 30	ASCII 2 digits Error code: 01H, 02H, 03H, 09H, 11H, 12H
	06	W		
	16	W		
45416	03	R	Sender address 31, 32	ASCII 2 digits Error code: 01H, 02H, 03H, 09H, 11H, 12H
	06	W		
	16	W		
45421	03	R	Mail account 1, 2	ASCII 2 digits Error code: 01H, 02H, 03H, 09H, 11H, 12H
	06	W		
	16	W		
45422	03	R	Mail account 3, 4	ASCII 2 digits Error code: 01H, 02H, 03H, 09H, 11H, 12H
	06	W		
	16	W		
45423	03	R	Mail account 5, 6	ASCII 2 digits Error code: 01H, 02H, 03H, 09H, 11H, 12H
	06	W		
	16	W		
45424	03	R	Mail account 7, 8	ASCII 2 digits Error code: 01H, 02H, 03H, 09H, 11H, 12H
	06	W		
	16	W		
45425	03	R	Mail account 9, 10	ASCII 2 digits Error code: 01H, 02H, 03H, 09H, 11H, 12H
	06	W		
	16	W		
45426	03	R	Mail account 11, 12	ASCII 2 digits Error code: 01H, 02H, 03H, 09H, 11H, 12H
	06	W		
	16	W		
45427	03	R	Mail account 13, 14	ASCII 2 digits Error code: 01H, 02H, 03H, 09H, 11H, 12H
	06	W		
	16	W		
45428	03	R	Mail account 15, 16	ASCII 2 digits Error code: 01H, 02H, 03H, 09H, 11H, 12H
	06	W		
	16	W		
45429	03	R	Mail account 17, 18	ASCII 2 digits Error code: 01H, 02H, 03H, 09H, 11H, 12H
	06	W		
	16	W		
45430	03	R	Mail account 19, 20	ASCII 2 digits Error code: 01H, 02H, 03H, 09H, 11H, 12H
	06	W		
	16	W		
45431	03	R	Mail account 21, 22	ASCII 2 digits Error code: 01H, 02H, 03H, 09H, 11H, 12H
	06	W		
	16	W		

Reference number	Applied function code	R/W	Content	Detail
45432	03 06 16	R W W	Mail account 23, 24	ASCII 2 digits Error code: 01H, 02H, 03H, 09H, 11H, 12H
45433	03 06 16	R W W	Mail account 25, 26	ASCII 2 digits Error code: 01H, 02H, 03H, 09H, 11H, 12H
45434	03 06 16	R W W	Mail account 27, 28	ASCII 2 digits Error code: 01H, 02H, 03H, 09H, 11H, 12H
45435	03 06 16	R W W	Mail account 29, 30	ASCII 2 digits Error code: 01H, 02H, 03H, 09H, 11H, 12H
45436	03 06 16	R W W	Mail account 31, 32	ASCII 2 digits Error code: 01H, 02H, 03H, 09H, 11H, 12H
45441	03 06 16	R W W	Mail password 1, 2	ASCII 2 digits Error code: 01H, 02H, 03H, 09H, 11H, 12H
45442	03 06 16	R W W	Mail password 3, 4	ASCII 2 digits Error code: 01H, 02H, 03H, 09H, 11H, 12H
45443	03 06 16	R W W	Mail password 5, 6	ASCII 2 digits Error code: 01H, 02H, 03H, 09H, 11H, 12H
45444	03 06 16	R W W	Mail password 7, 8	ASCII 2 digits Error code: 01H, 02H, 03H, 09H, 11H, 12H
45445	03 06 16	R W W	Mail password 9, 10	ASCII 2 digits Error code: 01H, 02H, 03H, 09H, 11H, 12H
45446	03 06 16	R W W	Mail password 11, 12	ASCII 2 digits Error code: 01H, 02H, 03H, 09H, 11H, 12H
45447	03 06 16	R W W	Mail password 13, 14	ASCII 2 digits Error code: 01H, 02H, 03H, 09H, 11H, 12H
45448	03 06 16	R W W	Mail password 15, 16	ASCII 2 digits Error code: 01H, 02H, 03H, 09H, 11H, 12H
45449	03 06 16	R W W	Mail password 17, 18	ASCII 2 digits Error code: 01H, 02H, 03H, 09H, 11H, 12H
45450	03 06 16	R W W	Mail password 19, 20	ASCII 2 digits Error code: 01H, 02H, 03H, 09H, 11H, 12H
45451	03 06 16	R W W	Mail password 21, 22	ASCII 2 digits Error code: 01H, 02H, 03H, 09H, 11H, 12H

Reference number	Applied function code	R/W	Content	Detail
45452	03	R	Mail password 23, 24	ASCII 2 digits
	06	W		Error code: 01H, 02H, 03H, 09H, 11H, 12H
	16	W		
45453	03	R	Mail password 25, 26	ASCII 2 digits
	06	W		Error code: 01H, 02H, 03H, 09H, 11H, 12H
	16	W		
45454	03	R	Mail password 27, 28	ASCII 2 digits
	06	W		Error code: 01H, 02H, 03H, 09H, 11H, 12H
	16	W		
45455	03	R	Mail password 29, 30	ASCII 2 digits
	06	W		Error code: 01H, 02H, 03H, 09H, 11H, 12H
	16	W		
45456	03	R	Mail password 31, 32	ASCII 2 digits
	06	W		Error code: 01H, 02H, 03H, 09H, 11H, 12H
	16	W		
45461	03	R	DNS On/Off	0: OFF, 1: ON
	06	W		Error code: 01H, 02H, 03H, 09H, 11H, 12H
	16	W		
45462	03	R	DNS primary server IP address 1, 2	Higher 16 bits
	06	W		Error code: 01H, 02H, 03H, 09H, 11H, 12H
	16	W		
45463	03	R	DNS primary server IP address 3, 4	Higher 16 bits
	06	W		Error code: 01H, 02H, 03H, 09H, 11H, 12H
	16	W		
45464	03	R	DNS secondary server IP address 1, 2	Higher 16 bits
	06	W		Error code: 01H, 02H, 03H, 09H, 11H, 12H
	16	W		
45465	03	R	DNS secondary server IP address 3, 4	Higher 16 bits
	06	W		Error code: 01H, 02H, 03H, 09H, 11H, 12H
	16	W		
45466	03	R	SNTP ON/OFF	0: OFF, 1: ON
	06	W		Error code: 01H, 02H, 03H, 09H, 11H, 12H
	16	W		
45467	03	R	SNTP server 1,2	Higher 16 bits
	06	W		Error code: 01H, 02H, 03H, 09H, 11H, 12H
	16	W		
45468	03	R	SNTP server 3,4	Higher 16 bits
	06	W		Error code: 01H, 02H, 03H, 09H, 11H, 12H
	16	W		
45469	03	R	SNTP server 5,6	Higher 16 bits
	06	W		Error code: 01H, 02H, 03H, 09H, 11H, 12H
	16	W		
45470	03	R	SNTP server 7,8	Higher 16 bits
	06	W		Error code: 01H, 02H, 03H, 09H, 11H, 12H
	16	W		
45471	03	R	SNTP server 9,10	Higher 16 bits
	06	W		Error code: 01H, 02H, 03H, 09H, 11H, 12H
	16	W		

Reference number	Applied function code	R/W	Content	Detail
45472	03 06 16	R W W	SNTP server 11,12	Higher 16 bits Error code: 01H, 02H, 03H, 09H, 11H, 12H
45473	03 06 16	R W W	SNTP server 13,14	Higher 16 bits Error code: 01H, 02H, 03H, 09H, 11H, 12H
45474	03 06 16	R W W	SNTP server 15,16	Higher 16 bits Error code: 01H, 02H, 03H, 09H, 11H, 12H
45475	03 06 16	R W W	SNTP server 17,18	Higher 16 bits Error code: 01H, 02H, 03H, 09H, 11H, 12H
45476	03 06 16	R W W	SNTP server 19,20	Higher 16 bits Error code: 01H, 02H, 03H, 09H, 11H, 12H
45477	03 06 16	R W W	SNTP server 21,22	Higher 16 bits Error code: 01H, 02H, 03H, 09H, 11H, 12H
45478	03 06 16	R W W	SNTP server 23,24	Higher 16 bits Error code: 01H, 02H, 03H, 09H, 11H, 12H
45479	03 06 16	R W W	SNTP server 25,26	Higher 16 bits Error code: 01H, 02H, 03H, 09H, 11H, 12H
45480	03 06 16	R W W	SNTP server 27,28	Higher 16 bits Error code: 01H, 02H, 03H, 09H, 11H, 12H
45481	03 06 16	R W W	SNTP server 29,30	Higher 16 bits Error code: 01H, 02H, 03H, 09H, 11H, 12H
45482	03 06 16	R W W	SNTP server 31,32	Higher 16 bits Error code: 01H, 02H, 03H, 09H, 11H, 12H
45483	03 06 16	R W W	SNTP base time	Higher 1byte base time hour: 0 to 23 Lower 1byte base time minute: 0 to 59 00:00 to 23:59 Error code: 01H,02H,03H, 09H,11H,12H
45484	03 06 16	R W W	SNTP interval	Higher 1byte base time hour: 0 to 24 Lower 1byte base time minute: 0 to 59 00:00 to 24:00 Error code: 01H,02H,03H, 09H,11H,12H
45485	03 06 16	R W W	SNTP port number	1 to 65536 Error code: 01H,02H,03H, 09H,11H,12H
45486	03 06 16	R W W	POP3 port number	1 to 65536 Error code: 01H,02H,03H, 09H,11H,12H

8-4-4 Low order communications parameter

R/W ... R: READ, W: WRITE

Reference number	Applied function code	R/W	Content	Detail
45501	03 06 16	R W W	Low order communication registration instruments number/channel number1	Higher 1 byte 0: No setting, 1 to 5: instruments number Lower 1 byte channel number: 1 to 200 Error code: 01H, 02H, 03H, 09H, 11H, 12H
45502	03 06 16	R W W	Low order communication registration instruments number/channel number2	Higher 1 byte 0: No setting, 1 to 5: instruments number Lower 1 byte channel number: 1 to 200 Error code: 01H, 02H, 03H, 09H, 11H, 12H
45503	03 06 16	R W W	Low order communication registration instruments number/channel number3	Higher 1 byte 0: No setting, 1 to 5: instruments number Lower 1 byte channel number: 1 to 200 Error code: 01H, 02H, 03H, 09H, 11H, 12H
45504	03 06 16	R W W	Low order communication registration instruments number/channel number4	Higher 1 byte 0: No setting, 1 to 5: instruments number Lower 1 byte channel number: 1 to 200 Error code: 01H, 02H, 03H, 09H, 11H, 12H
45505	03 06 16	R W W	Low order communication registration instruments number/channel number5	Higher 1 byte 0: No setting, 1 to 5: instruments number Lower 1 byte channel number: 1 to 200 Error code: 01H, 02H, 03H, 09H, 11H, 12H
45506	03 06 16	R W W	Low order communication registration instruments number/channel number6	Higher 1 byte 0: No setting, 1 to 5: instruments number Lower 1 byte channel number: 1 to 200 Error code: 01H, 02H, 03H, 09H, 11H, 12H
45507	03 06 16	R W W	Low order communication registration instruments number/channel number7	Higher 1 byte 0: No setting, 1 to 5: instruments number Lower 1 byte channel number: 1 to 200 Error code: 01H, 02H, 03H, 09H, 11H, 12H
45508	03 06 16	R W W	Low order communication registration instruments number/channel number8	Higher 1 byte 0: No setting, 1 to 5: instruments number Lower 1 byte channel number: 1 to 200 Error code: 01H, 02H, 03H, 09H, 11H, 12H
45509	03 06 16	R W W	Low order communication registration instruments number/channel number9	Higher 1 byte 0: No setting, 1 to 5: instruments number Lower 1 byte channel number: 1 to 200 Error code: 01H, 02H, 03H, 09H, 11H, 12H

Reference number	Applied function code	R/W	Content	Detail
45510	03 06 16	R W W	Low order communication registration instruments number/channel number10	Higher 1 byte 0: No setting, 1 to 5: instruments number Lower 1 byte channel number: 1 to 200 Error code: 01H, 02H, 03H, 09H, 11H, 12H
45511	03 06 16	R W W	Low order communication registration instruments number/channel number11	Higher 1 byte 0: No setting, 1 to 5: instruments number Lower 1 byte channel number: 1 to 200 Error code: 01H, 02H, 03H, 09H, 11H, 12H
45512	03 06 16	R W W	Low order communication registration instruments number/channel number12	Higher 1 byte 0: No setting, 1 to 5: instruments number Lower 1 byte channel number: 1 to 200 Error code: 01H, 02H, 03H, 09H, 11H, 12H
45513	03 06 16	R W W	Low order communication registration instruments number/channel number13	Higher 1 byte 0: No setting, 1 to 5: instruments number Lower 1 byte channel number: 1 to 200 Error code: 01H, 02H, 03H, 09H, 11H, 12H
45514	03 06 16	R W W	Low order communication registration instruments number/channel number14	Higher 1 byte 0: No setting, 1 to 5: instruments number Lower 1 byte channel number: 1 to 200 Error code: 01H, 02H, 03H, 09H, 11H, 12H
45515	03 06 16	R W W	Low order communication registration instruments number/channel number15	Higher 1 byte 0: No setting, 1 to 5: instruments number Lower 1 byte channel number: 1 to 200 Error code: 01H, 02H, 03H, 09H, 11H, 12H
45516	03 06 16	R W W	Low order communication registration instruments number/channel number16	Higher 1 byte 0: No setting, 1 to 5: instruments number Lower 1 byte channel number: 1 to 200 Error code: 01H, 02H, 03H, 09H, 11H, 12H
45517	03 06 16	R W W	Low order communication registration instruments number/channel number17	Higher 1 byte 0: No setting, 1 to 5: instruments number Lower 1 byte channel number: 1 to 200 Error code: 01H, 02H, 03H, 09H, 11H, 12H
45518	03 06 16	R W W	Low order communication registration instruments number/channel number18	Higher 1 byte 0: No setting, 1 to 5: instruments number Lower 1 byte channel number: 1 to 200 Error code: 01H, 02H, 03H, 09H, 11H, 12H
45519	03 06 16	R W W	Low order communication registration instruments number/channel number19	Higher 1 byte 0: No setting, 1 to 5: instruments number Lower 1 byte channel number: 1 to 200 Error code: 01H, 02H, 03H, 09H, 11H, 12H

Reference number	Applied function code	R/W	Content	Detail
45520	03 06 16	R W W	Low order communication registration instruments number/channel number20	Higher 1 byte 0: No setting, 1 to 5: instruments number Lower 1 byte channel number: 1 to 200 Error code: 01H, 02H, 03H, 09H, 11H, 12H
45521	03 06 16	R W W	Low order communication registration instruments number/channel number21	Higher 1 byte 0: No setting, 1 to 5: instruments number Lower 1 byte channel number: 1 to 200 Error code: 01H, 02H, 03H, 09H, 11H, 12H
45522	03 06 16	R W W	Low order communication registration instruments number/channel number22	Higher 1 byte 0: No setting, 1 to 5: instruments number Lower 1 byte channel number: 1 to 200 Error code: 01H, 02H, 03H, 09H, 11H, 12H
45523	03 06 16	R W W	Low order communication registration instruments number/channel number23	Higher 1 byte 0: No setting, 1 to 5: instruments number Lower 1 byte channel number: 1 to 200 Error code: 01H, 02H, 03H, 09H, 11H, 12H
45524	03 06 16	R W W	Low order communication registration instruments number/channel number24	Higher 1 byte 0: No setting, 1 to 5: instruments number Lower 1 byte channel number: 1 to 200 Error code: 01H, 02H, 03H, 09H, 11H, 12H
45525	03 06 16	R W W	Low order communication registration instruments number/channel number25	Higher 1 byte 0: No setting, 1 to 5: instruments number Lower 1 byte channel number: 1 to 200 Error code: 01H, 02H, 03H, 09H, 11H, 12H
45526	03 06 16	R W W	Low order communication registration instruments number/channel number26	Higher 1 byte 0: No setting, 1 to 5: instruments number Lower 1 byte channel number: 1 to 200 Error code: 01H, 02H, 03H, 09H, 11H, 12H
45527	03 06 16	R W W	Low order communication registration instruments number/channel number27	Higher 1 byte 0: No setting, 1 to 5: instruments number Lower 1 byte channel number: 1 to 200 Error code: 01H, 02H, 03H, 09H, 11H, 12H
45528	03 06 16	R W W	Low order communication registration instruments number/channel number28	Higher 1 byte 0: No setting, 1 to 5: instruments number Lower 1 byte channel number: 1 to 200 Error code: 01H, 02H, 03H, 09H, 11H, 12H
45529	03 06 16	R W W	Low order communication registration instruments number/channel number29	Higher 1 byte 0: No setting, 1 to 5: instruments number Lower 1 byte channel number: 1 to 200 Error code: 01H, 02H, 03H, 09H, 11H, 12H

Reference number	Applied function code	R/W	Content	Detail
45530	03 06 16	R W W	Low order communication registration instruments number/channel number30	Higher 1 byte 0: No setting, 1 to 5: instruments number Lower 1 byte channel number: 1 to 200 Error code: 01H, 02H, 03H, 09H, 11H, 12H
45531	03 06 16	R W W	Low order communication registration instruments number/channel number31	Higher 1 byte 0: No setting, 1 to 5: instruments number Lower 1 byte channel number: 1 to 200 Error code: 01H, 02H, 03H, 09H, 11H, 12H
45532	03 06 16	R W W	Low order communication registration instruments number/channel number32	Higher 1 byte 0: No setting, 1 to 5: instruments number Lower 1 byte channel number: 1 to 200 Error code: 01H, 02H, 03H, 09H, 11H, 12H
45533	03 06 16	R W W	Low order communication registration instruments number/channel number33	Higher 1 byte 0: No setting, 1 to 5: instruments number Lower 1 byte channel number: 1 to 200 Error code: 01H, 02H, 03H, 09H, 11H, 12H
45534	03 06 16	R W W	Low order communication registration instruments number/channel number34	Higher 1 byte 0: No setting, 1 to 5: instruments number Lower 1 byte channel number: 1 to 200 Error code: 01H, 02H, 03H, 09H, 11H, 12H
45535	03 06 16	R W W	Low order communication registration instruments number/channel number35	Higher 1 byte 0: No setting, 1 to 5: instruments number Lower 1 byte channel number: 1 to 200 Error code: 01H, 02H, 03H, 09H, 11H, 12H
45536	03 06 16	R W W	Low order communication registration instruments number/channel number36	Higher 1 byte 0: No setting, 1 to 5: instruments number Lower 1 byte channel number: 1 to 200 Error code: 01H, 02H, 03H, 09H, 11H, 12H
45537	03 06 16	R W W	Low order communication registration instruments number/channel number37	Higher 1 byte 0: No setting, 1 to 5: instruments number Lower 1 byte channel number: 1 to 200 Error code: 01H, 02H, 03H, 09H, 11H, 12H
45538	03 06 16	R W W	Low order communication registration instruments number/channel number38	Higher 1 byte 0: No setting, 1 to 5: instruments number Lower 1 byte channel number: 1 to 200 Error code: 01H, 02H, 03H, 09H, 11H, 12H
45539	03 06 16	R W W	Low order communication registration instruments number/channel number39	Higher 1 byte 0: No setting, 1 to 5: instruments number Lower 1 byte channel number: 1 to 200 Error code: 01H, 02H, 03H, 09H, 11H, 12H

Reference number	Applied function code	R/W	Content	Detail
45540	03 06 16	R W W	Low order communication registration instruments number/channel number40	Higher 1 byte 0: No setting, 1 to 5: instruments number Lower 1 byte channel number: 1 to 200 Error code: 01H, 02H, 03H, 09H, 11H, 12H
45541	03 06 16	R W W	Low order communication registration instruments number/channel number41	Higher 1 byte 0: No setting, 1 to 5: instruments number Lower 1 byte channel number: 1 to 200 Error code: 01H, 02H, 03H, 09H, 11H, 12H
45542	03 06 16	R W W	Low order communication registration instruments number/channel number42	Higher 1 byte 0: No setting, 1 to 5: instruments number Lower 1 byte channel number: 1 to 200 Error code: 01H, 02H, 03H, 09H, 11H, 12H
45543	03 06 16	R W W	Low order communication registration instruments number/channel number43	Higher 1 byte 0: No setting, 1 to 5: instruments number Lower 1 byte channel number: 1 to 200 Error code: 01H, 02H, 03H, 09H, 11H, 12H
45544	03 06 16	R W W	Low order communication registration instruments number/channel number44	Higher 1 byte 0: No setting, 1 to 5: instruments number Lower 1 byte channel number: 1 to 200 Error code: 01H, 02H, 03H, 09H, 11H, 12H
45545	03 06 16	R W W	Low order communication registration instruments number/channel number45	Higher 1 byte 0: No setting, 1 to 5: instruments number Lower 1 byte channel number: 1 to 200 Error code: 01H, 02H, 03H, 09H, 11H, 12H
45546	03 06 16	R W W	Low order communication registration instruments number/channel number46	Higher 1 byte 0: No setting, 1 to 5: instruments number Lower 1 byte channel number: 1 to 200 Error code: 01H, 02H, 03H, 09H, 11H, 12H
45547	03 06 16	R W W	Low order communication registration instruments number/channel number47	Higher 1 byte 0: No setting, 1 to 5: instruments number Lower 1 byte channel number: 1 to 200 Error code: 01H, 02H, 03H, 09H, 11H, 12H
45548	03 06 16	R W W	Low order communication registration instruments number/channel number48	Higher 1 byte 0: No setting, 1 to 5: instruments number Lower 1 byte channel number: 1 to 200 Error code: 01H, 02H, 03H, 09H, 11H, 12H
45549	03 06 16	R W W	Low order communication registration instruments number/channel number49	Higher 1 byte 0: No setting, 1 to 5: instruments number Lower 1 byte channel number: 1 to 200 Error code: 01H, 02H, 03H, 09H, 11H, 12H

Reference number	Applied function code	R/W	Content	Detail
45550	03 06 16	R W W	Low order communication registration instruments number/channel number50	Higher 1 byte 0: No setting, 1 to 5: instruments number Lower 1 byte channel number: 1 to 200 Error code: 01H, 02H, 03H, 09H, 11H, 12H
45551	03 06 16	R W W	Low order communication registration instruments number/channel number51	Higher 1 byte 0: No setting, 1 to 5: instruments number Lower 1 byte channel number: 1 to 200 Error code: 01H, 02H, 03H, 09H, 11H, 12H
45552	03 06 16	R W W	Low order communication registration instruments number/channel number52	Higher 1 byte 0: No setting, 1 to 5: instruments number Lower 1 byte channel number: 1 to 200 Error code: 01H, 02H, 03H, 09H, 11H, 12H
45553	03 06 16	R W W	Low order communication registration instruments number/channel number53	Higher 1 byte 0: No setting, 1 to 5: instruments number Lower 1 byte channel number: 1 to 200 Error code: 01H, 02H, 03H, 09H, 11H, 12H
45554	03 06 16	R W W	Low order communication registration instruments number/channel number54	Higher 1 byte 0: No setting, 1 to 5: instruments number Lower 1 byte channel number: 1 to 200 Error code: 01H, 02H, 03H, 09H, 11H, 12H
45555	03 06 16	R W W	Low order communication registration instruments number/channel number55	Higher 1 byte 0: No setting, 1 to 5: instruments number Lower 1 byte channel number: 1 to 200 Error code: 01H, 02H, 03H, 09H, 11H, 12H
45556	03 06 16	R W W	Low order communication registration instruments number/channel number56	Higher 1 byte 0: No setting, 1 to 5: instruments number Lower 1 byte channel number: 1 to 200 Error code: 01H, 02H, 03H, 09H, 11H, 12H
45557	03 06 16	R W W	Low order communication registration instruments number/channel number57	Higher 1 byte 0: No setting, 1 to 5: instruments number Lower 1 byte channel number: 1 to 200 Error code: 01H, 02H, 03H, 09H, 11H, 12H
45558	03 06 16	R W W	Low order communication registration instruments number/channel number58	Higher 1 byte 0: No setting, 1 to 5: instruments number Lower 1 byte channel number: 1 to 200 Error code: 01H, 02H, 03H, 09H, 11H, 12H
45559	03 06 16	R W W	Low order communication registration instruments number/channel number59	Higher 1 byte 0: No setting, 1 to 5: instruments number Lower 1 byte channel number: 1 to 200 Error code: 01H, 02H, 03H, 09H, 11H, 12H

Reference number	Applied function code	R/W	Content	Detail
45560	03 06 16	R W W	Low order communication registration instruments number/channel number60	Higher 1 byte 0: No setting, 1 to 5: instruments number Lower 1 byte channel number: 1 to 200 Error code: 01H, 02H, 03H, 09H, 11H, 12H
45561	03 06 16	R W W	Low order communication registration instruments number/channel number61	Higher 1 byte 0: No setting, 1 to 5: instruments number Lower 1 byte channel number: 1 to 200 Error code: 01H, 02H, 03H, 09H, 11H, 12H
45562	03 06 16	R W W	Low order communication registration instruments number/channel number62	Higher 1 byte 0: No setting, 1 to 5: instruments number Lower 1 byte channel number: 1 to 200 Error code: 01H, 02H, 03H, 09H, 11H, 12H
45563	03 06 16	R W W	Low order communication registration instruments number/channel number63	Higher 1 byte 0: No setting, 1 to 5: instruments number Lower 1 byte channel number: 1 to 200 Error code: 01H, 02H, 03H, 09H, 11H, 12H
45564	03 06 16	R W W	Low order communication registration instruments number/channel number64	Higher 1 byte 0: No setting, 1 to 5: instruments number Lower 1 byte channel number: 1 to 200 Error code: 01H, 02H, 03H, 09H, 11H, 12H
45565	03 06 16	R W W	Low order communication registration instruments number/channel number65	Higher 1 byte 0: No setting, 1 to 5: instruments number Lower 1 byte channel number: 1 to 200 Error code: 01H, 02H, 03H, 09H, 11H, 12H
45566	03 06 16	R W W	Low order communication registration instruments number/channel number66	Higher 1 byte 0: No setting, 1 to 5: instruments number Lower 1 byte channel number: 1 to 200 Error code: 01H, 02H, 03H, 09H, 11H, 12H
45567	03 06 16	R W W	Low order communication registration instruments number/channel number67	Higher 1 byte 0: No setting, 1 to 5: instruments number Lower 1 byte channel number: 1 to 200 Error code: 01H, 02H, 03H, 09H, 11H, 12H
45568	03 06 16	R W W	Low order communication registration instruments number/channel number68	Higher 1 byte 0: No setting, 1 to 5: instruments number Lower 1 byte channel number: 1 to 200 Error code: 01H, 02H, 03H, 09H, 11H, 12H
45569	03 06 16	R W W	Low order communication registration instruments number/channel number69	Higher 1 byte 0: No setting, 1 to 5: instruments number Lower 1 byte channel number: 1 to 200 Error code: 01H, 02H, 03H, 09H, 11H, 12H

Reference number	Applied function code	R/W	Content	Detail
45570	03 06 16	R W W	Low order communication registration instruments number/channel number70	Higher 1 byte 0: No setting, 1 to 5: instruments number Lower 1 byte channel number: 1 to 200 Error code: 01H, 02H, 03H, 09H, 11H, 12H
45571	03 06 16	R W W	Low order communication registration instruments number/channel number71	Higher 1 byte 0: No setting, 1 to 5: instruments number Lower 1 byte channel number: 1 to 200 Error code: 01H, 02H, 03H, 09H, 11H, 12H
45572	03 06 16	R W W	Low order communication registration instruments number/channel number72	Higher 1 byte 0: No setting, 1 to 5: instruments number Lower 1 byte channel number: 1 to 200 Error code: 01H, 02H, 03H, 09H, 11H, 12H
45573	03 06 16	R W W	Low order communication registration instruments number/channel number73	Higher 1 byte 0: No setting, 1 to 5: instruments number Lower 1 byte channel number: 1 to 200 Error code: 01H, 02H, 03H, 09H, 11H, 12H
45574	03 06 16	R W W	Low order communication registration instruments number/channel number74	Higher 1 byte 0: No setting, 1 to 5: instruments number Lower 1 byte channel number: 1 to 200 Error code: 01H, 02H, 03H, 09H, 11H, 12H
45575	03 06 16	R W W	Low order communication registration instruments number/channel number75	Higher 1 byte 0: No setting, 1 to 5: instruments number Lower 1 byte channel number: 1 to 200 Error code: 01H, 02H, 03H, 09H, 11H, 12H
45576	03 06 16	R W W	Low order communication registration instruments number/channel number76	Higher 1 byte 0: No setting, 1 to 5: instruments number Lower 1 byte channel number: 1 to 200 Error code: 01H, 02H, 03H, 09H, 11H, 12H
45577	03 06 16	R W W	Low order communication registration instruments number/channel number77	Higher 1 byte 0: No setting, 1 to 5: instruments number Lower 1 byte channel number: 1 to 200 Error code: 01H, 02H, 03H, 09H, 11H, 12H
45578	03 06 16	R W W	Low order communication registration instruments number/channel number78	Higher 1 byte 0: No setting, 1 to 5: instruments number Lower 1 byte channel number: 1 to 200 Error code: 01H, 02H, 03H, 09H, 11H, 12H
45579	03 06 16	R W W	Low order communication registration instruments number/channel number79	Higher 1 byte 0: No setting, 1 to 5: instruments number Lower 1 byte channel number: 1 to 200 Error code: 01H, 02H, 03H, 09H, 11H, 12H

Reference number	Applied function code	R/W	Content	Detail
45580	03 06 16	R W W	Low order communication registration instruments number/channel number80	Higher 1 byte 0: No setting, 1 to 5: instruments number Lower 1 byte channel number: 1 to 200 Error code: 01H, 02H, 03H, 09H, 11H, 12H
45581	03 06 16	R W W	Low order communication registration instruments number/channel number81	Higher 1 byte 0: No setting, 1 to 5: instruments number Lower 1 byte channel number: 1 to 200 Error code: 01H, 02H, 03H, 09H, 11H, 12H
45582	03 06 16	R W W	Low order communication registration instruments number/channel number82	Higher 1 byte 0: No setting, 1 to 5: instruments number Lower 1 byte channel number: 1 to 200 Error code: 01H, 02H, 03H, 09H, 11H, 12H
45583	03 06 16	R W W	Low order communication registration instruments number/channel number83	Higher 1 byte 0: No setting, 1 to 5: instruments number Lower 1 byte channel number: 1 to 200 Error code: 01H, 02H, 03H, 09H, 11H, 12H
45584	03 06 16	R W W	Low order communication registration instruments number/channel number84	Higher 1 byte 0: No setting, 1 to 5: instruments number Lower 1 byte channel number: 1 to 200 Error code: 01H, 02H, 03H, 09H, 11H, 12H
45585	03 06 16	R W W	Low order communication registration instruments number/channel number85	Higher 1 byte 0: No setting, 1 to 5: instruments number Lower 1 byte channel number: 1 to 200 Error code: 01H, 02H, 03H, 09H, 11H, 12H
45586	03 06 16	R W W	Low order communication registration instruments number/channel number86	Higher 1 byte 0: No setting, 1 to 5: instruments number Lower 1 byte channel number: 1 to 200 Error code: 01H, 02H, 03H, 09H, 11H, 12H
45587	03 06 16	R W W	Low order communication registration instruments number/channel number87	Higher 1 byte 0: No setting, 1 to 5: instruments number Lower 1 byte channel number: 1 to 200 Error code: 01H, 02H, 03H, 09H, 11H, 12H
45588	03 06 16	R W W	Low order communication registration instruments number/channel number88	Higher 1 byte 0: No setting, 1 to 5: instruments number Lower 1 byte channel number: 1 to 200 Error code: 01H, 02H, 03H, 09H, 11H, 12H
45589	03 06 16	R W W	Low order communication registration instruments number/channel number89	Higher 1 byte 0: No setting, 1 to 5: instruments number Lower 1 byte channel number: 1 to 200 Error code: 01H, 02H, 03H, 09H, 11H, 12H

Reference number	Applied function code	R/W	Content	Detail
45590	03 06 16	R W W	Low order communication registration instruments number/channel number90	Higher 1 byte 0: No setting, 1 to 5: instruments number Lower 1 byte channel number: 1 to 200 Error code: 01H, 02H, 03H, 09H, 11H, 12H
45591	03 06 16	R W W	Low order communication registration instruments number/channel number91	Higher 1 byte 0: No setting, 1 to 5: instruments number Lower 1 byte channel number: 1 to 200 Error code: 01H, 02H, 03H, 09H, 11H, 12H
45592	03 06 16	R W W	Low order communication registration instruments number/channel number92	Higher 1 byte 0: No setting, 1 to 5: instruments number Lower 1 byte channel number: 1 to 200 Error code: 01H, 02H, 03H, 09H, 11H, 12H
45593	03 06 16	R W W	Low order communication registration instruments number/channel number93	Higher 1 byte 0: No setting, 1 to 5: instruments number Lower 1 byte channel number: 1 to 200 Error code: 01H, 02H, 03H, 09H, 11H, 12H
45594	03 06 16	R W W	Low order communication registration instruments number/channel number94	Higher 1 byte 0: No setting, 1 to 5: instruments number Lower 1 byte channel number: 1 to 200 Error code: 01H, 02H, 03H, 09H, 11H, 12H
45595	03 06 16	R W W	Low order communication registration instruments number/channel number95	Higher 1 byte 0: No setting, 1 to 5: instruments number Lower 1 byte channel number: 1 to 200 Error code: 01H, 02H, 03H, 09H, 11H, 12H
45596	03 06 16	R W W	Low order communication registration instruments number/channel number96	Higher 1 byte 0: No setting, 1 to 5: instruments number Lower 1 byte channel number: 1 to 200 Error code: 01H, 02H, 03H, 09H, 11H, 12H
45597	03 06 16	R W W	Low order communication registration instruments number/channel number97	Higher 1 byte 0: No setting, 1 to 5: instruments number Lower 1 byte channel number: 1 to 200 Error code: 01H, 02H, 03H, 09H, 11H, 12H
45598	03 06 16	R W W	Low order communication registration instruments number/channel number98	Higher 1 byte 0: No setting, 1 to 5: instruments number Lower 1 byte channel number: 1 to 200 Error code: 01H, 02H, 03H, 09H, 11H, 12H
45599	03 06 16	R W W	Low order communication registration instruments number/channel number99	Higher 1 byte 0: No setting, 1 to 5: instruments number Lower 1 byte channel number: 1 to 200 Error code: 01H, 02H, 03H, 09H, 11H, 12H

Reference number	Applied function code	R/W	Content	Detail
45600	03 06 16	R W W	Low order communication registration instruments number/channel number100	Higher 1 byte 0: No setting, 1 to 5: instruments number Lower 1 byte channel number: 1 to 200 Error code: 01H, 02H, 03H, 09H, 11H, 12H
45601	03 06 16	R W W	Low order communication registration instruments number/channel number101	Higher 1 byte 0: No setting, 1 to 5: instruments number Lower 1 byte channel number: 1 to 200 Error code: 01H, 02H, 03H, 09H, 11H, 12H
45602	03 06 16	R W W	Low order communication registration instruments number/channel number102	Higher 1 byte 0: No setting, 1 to 5: instruments number Lower 1 byte channel number: 1 to 200 Error code: 01H, 02H, 03H, 09H, 11H, 12H
45603	03 06 16	R W W	Low order communication registration instruments number/channel number103	Higher 1 byte 0: No setting, 1 to 5: instruments number Lower 1 byte channel number: 1 to 200 Error code: 01H, 02H, 03H, 09H, 11H, 12H
45604	03 06 16	R W W	Low order communication registration instruments number/channel number104	Higher 1 byte 0: No setting, 1 to 5: instruments number Lower 1 byte channel number: 1 to 200 Error code: 01H, 02H, 03H, 09H, 11H, 12H
45605	03 06 16	R W W	Low order communication registration instruments number/channel number105	Higher 1 byte 0: No setting, 1 to 5: instruments number Lower 1 byte channel number: 1 to 200 Error code: 01H, 02H, 03H, 09H, 11H, 12H
45606	03 06 16	R W W	Low order communication registration instruments number/channel number106	Higher 1 byte 0: No setting, 1 to 5: instruments number Lower 1 byte channel number: 1 to 200 Error code: 01H, 02H, 03H, 09H, 11H, 12H
45607	03 06 16	R W W	Low order communication registration instruments number/channel number107	Higher 1 byte 0: No setting, 1 to 5: instruments number Lower 1 byte channel number: 1 to 200 Error code: 01H, 02H, 03H, 09H, 11H, 12H
45608	03 06 16	R W W	Low order communication registration instruments number/channel number108	Higher 1 byte 0: No setting, 1 to 5: instruments number Lower 1 byte channel number: 1 to 200 Error code: 01H, 02H, 03H, 09H, 11H, 12H
45609	03 06 16	R W W	Low order communication registration instruments number/channel number109	Higher 1 byte 0: No setting, 1 to 5: instruments number Lower 1 byte channel number: 1 to 200 Error code: 01H, 02H, 03H, 09H, 11H, 12H

Reference number	Applied function code	R/W	Content	Detail
45610	03 06 16	R W W	Low order communication registration instruments number/channel number110	Higher 1 byte 0: No setting, 1 to 5: instruments number Lower 1 byte channel number: 1 to 200 Error code: 01H, 02H, 03H, 09H, 11H, 12H
45611	03 06 16	R W W	Low order communication registration instruments number/channel number111	Higher 1 byte 0: No setting, 1 to 5: instruments number Lower 1 byte channel number: 1 to 200 Error code: 01H, 02H, 03H, 09H, 11H, 12H
45612	03 06 16	R W W	Low order communication registration instruments number/channel number112	Higher 1 byte 0: No setting, 1 to 5: instruments number Lower 1 byte channel number: 1 to 200 Error code: 01H, 02H, 03H, 09H, 11H, 12H
45613	03 06 16	R W W	Low order communication registration instruments number/channel number113	Higher 1 byte 0: No setting, 1 to 5: instruments number Lower 1 byte channel number: 1 to 200 Error code: 01H, 02H, 03H, 09H, 11H, 12H
45614	03 06 16	R W W	Low order communication registration instruments number/channel number114	Higher 1 byte 0: No setting, 1 to 5: instruments number Lower 1 byte channel number: 1 to 200 Error code: 01H, 02H, 03H, 09H, 11H, 12H
45615	03 06 16	R W W	Low order communication registration instruments number/channel number115	Higher 1 byte 0: No setting, 1 to 5: instruments number Lower 1 byte channel number: 1 to 200 Error code: 01H, 02H, 03H, 09H, 11H, 12H
45616	03 06 16	R W W	Low order communication registration instruments number/channel number116	Higher 1 byte 0: No setting, 1 to 5: instruments number Lower 1 byte channel number: 1 to 200 Error code: 01H, 02H, 03H, 09H, 11H, 12H
45617	03 06 16	R W W	Low order communication registration instruments number/channel number117	Higher 1 byte 0: No setting, 1 to 5: instruments number Lower 1 byte channel number: 1 to 200 Error code: 01H, 02H, 03H, 09H, 11H, 12H
45618	03 06 16	R W W	Low order communication registration instruments number/channel number118	Higher 1 byte 0: No setting, 1 to 5: instruments number Lower 1 byte channel number: 1 to 200 Error code: 01H, 02H, 03H, 09H, 11H, 12H
45619	03 06 16	R W W	Low order communication registration instruments number/channel number119	Higher 1 byte 0: No setting, 1 to 5: instruments number Lower 1 byte channel number: 1 to 200 Error code: 01H, 02H, 03H, 09H, 11H, 12H

Reference number	Applied function code	R/W	Content	Detail
45620	03 06 16	R W W	Low order communication registration instruments number/channel number120	Higher 1 byte 0:No setting,1 to 5: instruments number Lower 1 byte channel number:1 to 200 Error code:01H,02H,03H,09H,11H,12H

8-4-5 Group parameter(KR2S:1 to 5 group/KR3S:1 to 6 group)

R/W ... R: READ, W: WRITE

Reference number	Applied function code	R/W	Content	Detail
46001	03	R	Group 1	ASCII, Shift JIS 2 digits Error code: 01H, 02H, 03H, 09H, 11H, 12H
	06	W	Display group name	
	16	W	1, 2	
46002	03	R	Group 1	ASCII, Shift JIS 2 digits Error code: 01H, 02H, 03H, 09H, 11H, 12H
	06	W	Display group name	
	16	W	3, 4	
46003	03	R	Group 1	ASCII, Shift JIS 2 digits Error code: 01H, 02H, 03H, 09H, 11H, 12H
	06	W	Display group name	
	16	W	5, 6	
46004	03	R	Group 1	ASCII, Shift JIS 2 digits Error code: 01H, 02H, 03H, 09H, 11H, 12H
	06	W	Display group name	
	16	W	7, 8	
46005	03	R	Group 1	ASCII, Shift JIS 2 digits Error code: 01H, 02H, 03H, 09H, 11H, 12H
	06	W	Display group name	
	16	W	9, 10	
46006	03	R	Group 1	ASCII, Shift JIS 2 digits Error code: 01H, 02H, 03H, 09H, 11H, 12H
	06	W	Display group name	
	16	W	11, 12	
46007	03	R	Group 1	ASCII, Shift JIS 2 digits Error code: 01H, 02H, 03H, 09H, 11H, 12H
	06	W	Display group name	
	16	W	13, 14	
46008	03	R	Group 1	ASCII, Shift JIS 2 digits Error code: 01H, 02H, 03H, 09H, 11H, 12H
	06	W	Display group name	
	16	W	15, 16	
46011	03	R	Group 1	Bit 0 to 7 Display channel allocation: 1 to Number of recording points, 0: Not set Bit 8 to 10 Trend line diameter 0: 1, 1: 2, 2: 3, 3: 4, 4: 5 Bit 12 Display_Nondisplay 0: Nondisplay, 1: Display Error code: 01H, 02H, 03H, 09H, 11H, 12H
	06	W	Display channel	
	16	W	allocaton/Display_No ndisplay/Trend line diameter 1	
46012	03	R	Group 1	Bit 0 to 7 Display channel allocation: 1 to Number of recording points, 0: Not set Bit 8 to 10 Trend line diameter 0: 1, 1: 2, 2: 3, 3: 4, 4: 5 Bit 12 Display_Nondisplay 0: Nondisplay, 1: Display Error code: 01H, 02H, 03H, 09H, 11H, 12H
	06	W	Display channel	
	16	W	allocaton/Display_No ndisplay/Trend line diameter 2	
46013	03	R	Group 1	Bit 0 to 7 Display channel allocation: 1 to Number of recording points, 0: Not set Bit 8 to 10 Trend line diameter 0: 1, 1: 2, 2: 3, 3: 4, 4: 5 Bit 12 Display_Nondisplay 0: Nondisplay, 1: Display Error code: 01H, 02H, 03H, 09H, 11H, 12H
	06	W	Display channel	
	16	W	allocaton/Display_No ndisplay/Trend line diameter 3	

Reference number	Applied function code	R/W	Content	Detail
46014	03 06 16	R W W	Group 1 Display channel allocaton/Display_No ndisplay/Trend line diameter 4	Bit 0 to 7 Display channel allocation: 1 to Number of recording points, 0: Not set Bit 8 to 10 Trend line diameter 0: 1, 1: 2, 2: 3, 3: 4, 4: 5 Bit 12 Display_Nondisplay 0: Nondisplay, 1: Display Error code: 01H, 02H, 03H, 09H, 11H, 12H
46015	03 06 16	R W W	Group 1 Display channel allocaton/Display_No ndisplay/Trend line diameter 5	Bit 0 to 7 Display channel allocation: 1 to Number of recording points, 0: Not set Bit 8 to 10 Trend line diameter 0: 1, 1: 2, 2: 3, 3: 4, 4: 5 Bit 12 Display_Nondisplay 0: Nondisplay, 1: Display Error code: 01H, 02H, 03H, 09H, 11H, 12H
46016	03 06 16	R W W	Group 1 Display channel allocaton/Display_No ndisplay/Trend line diameter 6	Bit 0 to 7 Display channel allocation: 1 to Number of recording points, 0: Not set Bit 8 to 10 Trend line diameter 0: 1, 1: 2, 2: 3, 3: 4, 4: 5 Bit 12 Display_Nondisplay 0: Nondisplay, 1: Display Error code: 01H, 02H, 03H, 09H, 11H, 12H
46017	03 06 16	R W W	Group 1 Display channel allocaton/Display_No ndisplay/Trend line diameter 7	Bit 0 to 7 Display channel allocation: 1 to Number of recording points, 0: Not set Bit 8 to 10 Trend line diameter 0: 1, 1: 2, 2: 3, 3: 4, 4: 5 Bit 12 Display_Nondisplay 0: Nondisplay, 1: Display Error code: 01H, 02H, 03H, 09H, 11H, 12H
46018	03 06 16	R W W	Group 1 Display channel allocaton/Display_No ndisplay/Trend line diameter 8	Bit 0 to 7 Display channel allocation: 1 to Number of recording points, 0: Not set Bit 8 to 10 Trend line diameter 0: 1, 1: 2, 2: 3, 3: 4, 4: 5 Bit 12 Display_Nondisplay 0: Nondisplay, 1: Display Error code: 01H, 02H, 03H, 09H, 11H, 12H
46019	03 06 16	R W W	Group 1 Display channel allocaton/Display_No ndisplay/Trend line diameter 9	Bit 0 to 7 Display channel allocation: 1 to Number of recording points, 0: Not set Bit 8 to 10 Trend line diameter 0: 1, 1: 2, 2: 3, 3: 4, 4: 5 Bit 12 Display_Nondisplay 0: Nondisplay, 1: Display Error code: 01H, 02H, 03H, 09H, 11H, 12H
46020	03 06 16	R W W	Group 1 Display channel allocaton/Display_No ndisplay/Trend line diameter 10	Bit 0 to 7 Display channel allocation: 1 to Number of recording points, 0: Not set Bit 8 to 10 Trend line diameter 0: 1, 1: 2, 2: 3, 3: 4, 4: 5 Bit 12 Display_Nondisplay 0: Nondisplay, 1: Display Error code: 01H, 02H, 03H, 09H, 11H, 12H

Reference number	Applied function code	R/W	Content	Detail
46021	03 06 16	R W W	Group 1 Display channel allocaton/Display_No ndisplay/Trend line diameter 11	Bit 0 to 7 Display channel allocation: 1 to Number of recording points, 0: Not set Bit 8 to 10 Trend line diameter 0: 1, 1: 2, 2: 3, 3: 4, 4: 5 Bit 12 Display_Nondisplay 0: Nondisplay, 1: Display Error code: 01H, 02H, 03H, 09H, 11H, 12H
46022	03 06 16	R W W	Group 1 Display channel allocaton/Display_No ndisplay/Trend line diameter 12	Bit 0 to 7 Display channel allocation: 1 to Number of recording points, 0: Not set Bit 8 to 10 Trend line diameter 0: 1, 1: 2, 2: 3, 3: 4, 4: 5 Bit 12 Display_Nondisplay 0: Nondisplay, 1: Display Error code: 01H, 02H, 03H, 09H, 11H, 12H
46023	03 06 16	R W W	Group 1 Display channel allocaton/Display_No ndisplay/Trend line diameter 13	Bit 0 to 7 Display channel allocation: 1 to Number of recording points, 0: Not set Bit 8 to 10 Trend line diameter 0: 1, 1: 2, 2: 3, 3: 4, 4: 5 Bit 12 Display_Nondisplay 0: Nondisplay, 1: Display Error code: 01H, 02H, 03H, 09H, 11H, 12H
46024	03 06 16	R W W	Group 1 Display channel allocaton/Display_No ndisplay/Trend line diameter 14	Bit 0 to 7 Display channel allocation: 1 to Number of recording points, 0: Not set Bit 8 to 10 Trend line diameter 0: 1, 1: 2, 2: 3, 3: 4, 4: 5 Bit 12 Display_Nondisplay 0: Nondisplay, 1: Display Error code: 01H, 02H, 03H, 09H, 11H, 12H
46025	03 06 16	R W W	Group 1 Display channel allocaton/Display_No ndisplay/Trend line diameter 15	Bit 0 to 7 Display channel allocation: 1 to Number of recording points, 0: Not set Bit 8 to 10 Trend line diameter 0: 1, 1: 2, 2: 3, 3: 4, 4: 5 Bit 12 Display_Nondisplay 0: Nondisplay, 1: Display Error code: 01H, 02H, 03H, 09H, 11H, 12H
46026	03 06 16	R W W	Group 1 Display channel allocaton/Display_No ndisplay/Trend line diameter 16	Bit 0 to 7 Display channel allocation: 1 to Number of recording points, 0: Not set Bit 8 to 10 Trend line diameter 0: 1, 1: 2, 2: 3, 3: 4, 4: 5 Bit 12 Display_Nondisplay 0: Nondisplay, 1: Display Error code: 01H, 02H, 03H, 09H, 11H, 12H
46027	03 06 16	R W W	Group 1 Display channel allocaton/Display_No ndisplay/Trend line diameter 17	Bit 0 to 7 Display channel allocation: 1 to Number of recording points, 0: Not set Bit 8 to 10 Trend line diameter 0: 1, 1: 2, 2: 3, 3: 4, 4: 5 Bit 12 Display_Nondisplay 0: Nondisplay, 1: Display Error code: 01H, 02H, 03H, 09H, 11H, 12H

Reference number	Applied function code	R/W	Content	Detail
46028	03 06 16	R W W	Group 1 Display channel allocaton/Display_No ndisplay/Trend line diameter 18	Bit 0 to 7 Display channel allocation: 1 to Number of recording points, 0: Not set Bit 8 to 10 Trend line diameter 0: 1, 1: 2, 2: 3, 3: 4, 4: 5 Bit 12 Display_Nondisplay 0: Nondisplay, 1: Display Error code: 01H, 02H, 03H, 09H, 11H, 12H
46029	03 06 16	R W W	Group 1 Display channel allocaton/Display_No ndisplay/Trend line diameter 19	Bit 0 to 7 Display channel allocation: 1 to Number of recording points, 0: Not set Bit 8 to 10 Trend line diameter 0: 1, 1: 2, 2: 3, 3: 4, 4: 5 Bit 12 Display_Nondisplay 0: Nondisplay, 1: Display Error code: 01H, 02H, 03H, 09H, 11H, 12H
46030	03 06 16	R W W	Group 1 Display channel allocaton/Display_No ndisplay/Trend line diameter 20	Bit 0 to 7 Display channel allocation: 1 to Number of recording points, 0: Not set Bit 8 to 10 Trend line diameter 0: 1, 1: 2, 2: 3, 3: 4, 4: 5 Bit 12 Display_Nondisplay 0: Nondisplay, 1: Display Error code: 01H, 02H, 03H, 09H, 11H, 12H
46031	03 06 16	R W W	Group 1 Display channel allocaton/Display_No ndisplay/Trend line diameter 21	Bit 0 to 7 Display channel allocation: 1 to Number of recording points, 0: Not set Bit 8 to 10 Trend line diameter 0: 1, 1: 2, 2: 3, 3: 4, 4: 5 Bit 12 Display_Nondisplay 0: Nondisplay, 1: Display Error code: 01H, 02H, 03H, 09H, 11H, 12H
46032	03 06 16	R W W	Group 1 Display channel allocaton/Display_No ndisplay/Trend line diameter 22	Bit 0 to 7 Display channel allocation: 1 to Number of recording points, 0: Not set Bit 8 to 10 Trend line diameter 0: 1, 1: 2, 2: 3, 3: 4, 4: 5 Bit 12 Display_Nondisplay 0: Nondisplay, 1: Display Error code: 01H, 02H, 03H, 09H, 11H, 12H
46033	03 06 16	R W W	Group 1 Display channel allocaton/Display_No ndisplay/Trend line diameter 23	Bit 0 to 7 Display channel allocation: 1 to Number of recording points, 0: Not set Bit 8 to 10 Trend line diameter 0: 1, 1: 2, 2: 3, 3: 4, 4: 5 Bit 12 Display_Nondisplay 0: Nondisplay, 1: Display Error code: 01H, 02H, 03H, 09H, 11H, 12H
46034	03 06 16	R W W	Group 1 Display channel allocaton/Display_No ndisplay/Trend line diameter 24	Bit 0 to 7 Display channel allocation: 1 to Number of recording points, 0: Not set Bit 8 to 10 Trend line diameter 0: 1, 1: 2, 2: 3, 3: 4, 4: 5 Bit 12 Display_Nondisplay 0: Nondisplay, 1: Display Error code: 01H, 02H, 03H, 09H, 11H, 12H

Reference number	Applied function code	R/W	Content	Detail
46035	03 06 16	R W W	Group 1 Display channel allocaton/Display_No ndisplay/Trend line diameter 25	Bit 0 to 7 Display channel allocation: 1 to Number of recording points, 0: Not set Bit 8 to 10 Trend line diameter 0: 1, 1: 2, 2: 3, 3: 4, 4: 5 Bit 12 Display_Nondisplay 0: Nondisplay, 1: Display Error code: 01H, 02H, 03H, 09H, 11H, 12H
46036	03 06 16	R W W	Group 1 Display channel allocaton/Display_No ndisplay/Trend line diameter 26	Bit 0 to 7 Display channel allocation: 1 to Number of recording points, 0: Not set Bit 8 to 10 Trend line diameter 0: 1, 1: 2, 2: 3, 3: 4, 4: 5 Bit 12 Display_Nondisplay 0: Nondisplay, 1: Display Error code: 01H, 02H, 03H, 09H, 11H, 12H
46037	03 06 16	R W W	Group 1 Display channel allocaton/Display_No ndisplay/Trend line diameter 27	Bit 0 to 7 Display channel allocation: 1 to Number of recording points, 0: Not set Bit 8 to 10 Trend line diameter 0: 1, 1: 2, 2: 3, 3: 4, 4: 5 Bit 12 Display_Nondisplay 0: Nondisplay, 1: Display Error code: 01H, 02H, 03H, 09H, 11H, 12H
46038	03 06 16	R W W	Group 1 Display channel allocaton/Display_No ndisplay/Trend line diameter 28	Bit 0 to 7 Display channel allocation: 1 to Number of recording points, 0: Not set Bit 8 to 10 Trend line diameter 0: 1, 1: 2, 2: 3, 3: 4, 4: 5 Bit 12 Display_Nondisplay 0: Nondisplay, 1: Display Error code: 01H, 02H, 03H, 09H, 11H, 12H
46039	03 06 16	R W W	Group 1 Display channel allocaton/Display_No ndisplay/Trend line diameter 29	Bit 0 to 7 Display channel allocation: 1 to Number of recording points, 0: Not set Bit 8 to 10 Trend line diameter 0: 1, 1: 2, 2: 3, 3: 4, 4: 5 Bit 12 Display_Nondisplay 0: Nondisplay, 1: Display Error code: 01H, 02H, 03H, 09H, 11H, 12H
46040	03 06 16	R W W	Group 1 Display channel allocaton/Display_No ndisplay/Trend line diameter 30	Bit 0 to 7 Display channel allocation: 1 to Number of recording points, 0: Not set Bit 8 to 10 Trend line diameter 0: 1, 1: 2, 2: 3, 3: 4, 4: 5 Bit 12 Display_Nondisplay 0: Nondisplay, 1: Display Error code: 01H, 02H, 03H, 09H, 11H, 12H
46041	03 06 16	R W W	Group 1 Display channel allocaton/Display_No ndisplay/Trend line diameter 31	Bit 0 to 7 Display channel allocation: 1 to Number of recording points, 0: Not set Bit 8 to 10 Trend line diameter 0: 1, 1: 2, 2: 3, 3: 4, 4: 5 Bit 12 Display_Nondisplay 0: Nondisplay, 1: Display Error code: 01H, 02H, 03H, 09H, 11H, 12H

Reference number	Applied function code	R/W	Content	Detail
46042	03 06 16	R W W	Group 1 Display channel allocaton/Display_No ndisplay/Trend line diameter 32	Bit 0 to 7 Display channel allocation: 1 to Number of recording points, 0: Not set Bit 8 to 10 Trend line diameter 0: 1, 1: 2, 2: 3, 3: 4, 4: 5 Bit 12 Display_Nondisplay 0: Nondisplay, 1: Display Error code: 01H, 02H, 03H, 09H, 11H, 12H
46043	03 06 16	R W W	Group 1 Display channel allocaton/Display_No ndisplay/Trend line diameter 33	Bit 0 to 7 Display channel allocation: 1 to Number of recording points, 0: Not set Bit 8 to 10 Trend line diameter 0: 1, 1: 2, 2: 3, 3: 4, 4: 5 Bit 12 Display_Nondisplay 0: Nondisplay, 1: Display Error code: 01H, 02H, 03H, 09H, 11H, 12H
46044	03 06 16	R W W	Group 1 Display channel allocaton/Display_No ndisplay/Trend line diameter 34	Bit 0 to 7 Display channel allocation: 1 to Number of recording points, 0: Not set Bit 8 to 10 Trend line diameter 0: 1, 1: 2, 2: 3, 3: 4, 4: 5 Bit 12 Display_Nondisplay 0: Nondisplay, 1: Display Error code: 01H, 02H, 03H, 09H, 11H, 12H
46045	03 06 16	R W W	Group 1 Display channel allocaton/Display_No ndisplay/Trend line diameter 35	Bit 0 to 7 Display channel allocation: 1 to Number of recording points, 0: Not set Bit 8 to 10 Trend line diameter 0: 1, 1: 2, 2: 3, 3: 4, 4: 5 Bit 12 Display_Nondisplay 0: Nondisplay, 1: Display Error code: 01H, 02H, 03H, 09H, 11H, 12H
46046	03 06 16	R W W	Group 1 Display channel allocaton/Display_No ndisplay/Trend line diameter 36	Bit 0 to 7 Display channel allocation: 1 to Number of recording points, 0: Not set Bit 8 to 10 Trend line diameter 0: 1, 1: 2, 2: 3, 3: 4, 4: 5 Bit 12 Display_Nondisplay 0: Nondisplay, 1: Display Error code: 01H, 02H, 03H, 09H, 11H, 12H
46047	03 06 16	R W W	Group 1 Display channel allocaton/Display_No ndisplay/Trend line diameter 37	Bit 0 to 7 Display channel allocation: 1 to Number of recording points, 0: Not set Bit 8 to 10 Trend line diameter 0: 1, 1: 2, 2: 3, 3: 4, 4: 5 Bit 12 Display_Nondisplay 0: Nondisplay, 1: Display Error code: 01H, 02H, 03H, 09H, 11H, 12H
46048	03 06 16	R W W	Group 1 Display channel allocaton/Display_No ndisplay/Trend line diameter 38	Bit 0 to 7 Display channel allocation: 1 to Number of recording points, 0: Not set Bit 8 to 10 Trend line diameter 0: 1, 1: 2, 2: 3, 3: 4, 4: 5 Bit 12 Display_Nondisplay 0: Nondisplay, 1: Display Error code: 01H, 02H, 03H, 09H, 11H, 12H

Reference number	Applied function code	R/W	Content	Detail
46049	03 06 16	R W W	Group 1 Display channel allocaton/Display_No ndisplay/Trend line diameter 39	Bit 0 to 7 Display channel allocation: 1 to Number of recording points, 0: Not set Bit 8 to 10 Trend line diameter 0: 1, 1: 2, 2: 3, 3: 4, 4: 5 Bit 12 Display_Nondisplay 0: Nondisplay, 1: Display Error code: 01H, 02H, 03H, 09H, 11H, 12H
46050	03 06 16	R W W	Group 1 Display channel allocaton/Display_No ndisplay/Trend line diameter 40	Bit 0 to 7 Display channel allocation: 1 to Number of recording points, 0: Not set Bit 8 to 10 Trend line diameter 0: 1, 1: 2, 2: 3, 3: 4, 4: 5 Bit 12 Display_Nondisplay 0: Nondisplay, 1: Display Error code: 01H, 02H, 03H, 09H, 11H, 12H
46051	03 06 16	R W W	Group 1 Display channel allocaton/Display_No ndisplay/Trend line diameter 41	Bit 0 to 7 Display channel allocation: 1 to Number of recording points, 0: Not set Bit 8 to 10 Trend line diameter 0: 1, 1: 2, 2: 3, 3: 4, 4: 5 Bit 12 Display_Nondisplay 0: Nondisplay, 1: Display Error code: 01H, 02H, 03H, 09H, 11H, 12H
46052	03 06 16	R W W	Group 1 Display channel allocaton/Display_No ndisplay/Trend line diameter 42	Bit 0 to 7 Display channel allocation: 1 to Number of recording points, 0: Not set Bit 8 to 10 Trend line diameter 0: 1, 1: 2, 2: 3, 3: 4, 4: 5 Bit 12 Display_Nondisplay 0: Nondisplay, 1: Display Error code: 01H, 02H, 03H, 09H, 11H, 12H
46053	03 06 16	R W W	Group 1 Display channel allocaton/Display_No ndisplay/Trend line diameter 43	Bit 0 to 7 Display channel allocation: 1 to Number of recording points, 0: Not set Bit 8 to 10 Trend line diameter 0: 1, 1: 2, 2: 3, 3: 4, 4: 5 Bit 12 Display_Nondisplay 0: Nondisplay, 1: Display Error code: 01H, 02H, 03H, 09H, 11H, 12H
46054	03 06 16	R W W	Group 1 Display channel allocaton/Display_No ndisplay/Trend line diameter 44	Bit 0 to 7 Display channel allocation: 1 to Number of recording points, 0: Not set Bit 8 to 10 Trend line diameter 0: 1, 1: 2, 2: 3, 3: 4, 4: 5 Bit 12 Display_Nondisplay 0: Nondisplay, 1: Display Error code: 01H, 02H, 03H, 09H, 11H, 12H
46055	03 06 16	R W W	Group 1 Time ruler interval	12 to 510 (Only the even number value) Error code: 01H, 02H, 03H, 09H, 11H, 12H
46061	03 06 16	R W W	Group 1 Trip line position 1	1 to 99 0: None Error code: 01H, 02H, 03H, 09H, 11H, 12H
46062	03 06 16	R W W	Group 1 Trip line color 1	1 to 12 Error code: 01H, 02H, 03H, 09H, 11H, 12H

Reference number	Applied function code	R/W	Content	Detail
46063	03 06 16	R W W	Group 1 Trip line thickness 1	0: 1, 1: 2, 2: 3, 3: 4, 4: 5 Error code: 01H, 02H, 03H, 09H, 11H, 12H
46064	03 06 16	R W W	Group 1 Trip line position 2	1 to 99 0: None Error code: 01H, 02H, 03H, 09H, 11H, 12H
46065	03 06 16	R W W	Group 1 Trip line color 2	1 to 12 Error code: 01H, 02H, 03H, 09H, 11H, 12H
46066	03 06 16	R W W	Group 1 Trip line thickness 2	0: 1, 1: 2, 2: 3, 3: 4, 4: 5 Error code: 01H, 02H, 03H, 09H, 11H, 12H
46067	03 06 16	R W W	Group 1 Trip line position 3	1 to 99 0: None Error code: 01H, 02H, 03H, 09H, 11H, 12H
46068	03 06 16	R W W	Group 1 Trip line color 3	1 to 12 Error code: 01H, 02H, 03H, 09H, 11H, 12H
46069	03 06 16	R W W	Group 1 Trip line thickness 3	0: 1, 1: 2, 2: 3, 3: 4, 4: 5 Error code: 01H, 02H, 03H, 09H, 11H, 12H
46070	03 06 16	R W W	Group 1 Trip line position 4	1 to 99 0: None Error code: 01H, 02H, 03H, 09H, 11H, 12H
46071	03 06 16	R W W	Group 1 Trip line color 4	1 to 12 Error code: 01H, 02H, 03H, 09H, 11H, 12H
46072	03 06 16	R W W	Group 1 Trip line thickness 4	0: 1, 1: 2, 2: 3, 3: 4, 4: 5 Error code: 01H, 02H, 03H, 09H, 11H, 12H
46101 to 46200	03 06 16	R W W	Group 2 parameter	Same as Group 1 parameter (46001 to 46072)
46201 to 46300	03 06 16	R W W	Group 3 parameter	Same as Group 1 parameter (46001 to 46072)
46301 to 46400	03 06 16	R W W	Group 4 parameter	Same as Group 1 parameter (46001 to 46072)
46401 to 46500	03 06 16	R W W	Group 5 parameter	Same as Group 1 parameter (46001 to 46072)
46501 to 46600	03 06 16	R W W	Group 6 parameter	Same as Group 1 parameter (46001 to 46072)

8-4-6 Common parameter (screen, schedule, etc.)

R/W ... R: READ, W: WRITE

Reference number	Applied function code	R/W	Content	Detail
47110	03 06 16	R W W	Language	0: Japanese, 1: English Error code: 01H, 02H, 03H, 09H, 11H, 12H
47111	03 06 16	R W W	Screen saver	0 to 60 (min.) Error code: 01H, 02H, 03H, 09H, 11H, 12H
47112	03 06 16	R W W	Year/month/day format	0: y/m/d, 1: m/d/y, 2: d/m/y Error code: 01H, 02H, 03H, 09H, 11H, 12H
47113	03 06 16	R W W	Time adjustment by DI	0: none, 1 to 4 DI number Error code: 01H, 02H, 03H, 09H, 11H, 12H
47114	03 06 16	R W W	Background color	0: White, 1: Black Error code: 01H, 02H, 03H, 09H, 11H, 12H
47115	03 06 16	R W W	Display contrast adjustment	1 to 4 (Default: 3) Error code: 01H, 02H, 03H, 09H, 11H, 12H
47117	03 06 16	R W W	Combined display	0: W/o tag, 1: With tag, 2: Bargraph, 3: None Error code: 01H, 02H, 03H, 09H, 11H, 12H
47118	03 06 16	R W W	Trend direction	0: Vertical, 1: Horizontal Error code: 01H, 02H, 03H, 09H, 11H, 12H
47119	03 06 16	R W W	Bargraph direction	0: Vertical, 1: Horizontal Error code: 01H, 02H, 03H, 09H, 11H, 12H
47120	03 06 16	R W W	Number of frames for numeric number display screen	1, 2, 3, 4, 6, 8, 9, 10, 12, 24, 44 switching Error code: 01H, 02H, 03H, 09H, 11H, 12H
47122	03 06 16	R W W	Zone used/not used	0: Not used, 1: Used Error code: 01H, 02H, 03H, 09H, 11H, 12H
47123	03 06 16	R W W	Automatic changing interval	0 to 60 Error code: 01H, 02H, 03H, 09H, 11H, 12H
47124	03 06 16	R W W	Numeric number display update speed	0: 0.5s, 1: 1s Error code: 01H, 02H, 03H, 09H, 11H, 12H
47125	03 06 16	R W W	Scale text	0: With display, 1: W/o display Error code: 01H, 02H, 03H, 09H, 11H, 12H
47126	03 06 16	R W W	Base position of bargraph	0 to 100 Error code: 01H, 02H, 03H, 09H, 11H, 12H

Reference number	Applied function code	R/W	Content	Detail
47127	03 06 16	R W W	Min/Max display	0: With display, 1: W/o display Error code: 01H, 02H, 03H, 09H, 11H, 12H
47128	03 06 16	R W W	Data display Size adjustment	0: w/o adjustment , 1: with adjustment Error code: 01H, 02H, 03H, 09H, 11H, 12H
47129	03 06 16	R W W	Trend label	0: none , 1: CH tag , 2: tag Error code: 01H, 02H, 03H, 09H, 11H, 12H
47130	03 06 16	R W W	Dual trend synchronization	0: w/o synchronization , 1:with synchronization Error code: 01H, 02H, 03H, 09H, 11H, 12H
47140	03 06 16	R W W	Low order communication connected model 1	0: No connection ,1: SE, 2:AL , 3:BR, 4: KE,5: LE 6: KR, 7: LT2/3/8, 8: LT4 ,9: JU, 10: JW, 11: MELSEC, 12: SYSMAC Error code: 01H, 02H, 03H, 09H, 11H, 12H
47141	03 06 16	R W W	Low order communication connected model 2	Same as Low order communication connection instrument 1 (47140)
47142	03 06 16	R W W	Low order communication connected model 3	Same as Low order communication connection instrument 1 (47140)
47143	03 06 16	R W W	Low order communication connected model 4	Same as Low order communication connection instrument 1 (47140)
47144	03 06 16	R W W	Low order communication connected model 5	Same as Low order communication connection instrument 1 (47140)
47150	03 06 16	R W W	Low order communication number of instrument CH 1	0: CH none, 1 to 200: Number of CH of low order connection instrument Error code: 01H, 02H, 03H, 09H, 11H, 12H
47151	03 06 16	R W W	Low order communication number of instrument CH 2	0: CH none, 1 to 200: Number of CH of low order connection instrument Error code: 01H, 02H, 03H, 09H, 11H, 12H

Reference number	Applied function code	R/W	Content	Detail
47152	03 06 16	R W W	Low order communication number of instrument CH 3	0: CH none, 1 to 200: Number of CH of low order connection instrument Error code: 01H, 02H, 03H, 09H, 11H, 12H
47153	03 06 16	R W W	Low order communication number of instrument CH 4	0: CH none, 1 to 200: Number of CH of low order connection instrument Error code: 01H, 02H, 03H, 09H, 11H, 12H
47154	03 06 16	R W W	Low order communication number of instrument CH 5	0: CH none, 1 to 200: Number of CH of low order connection instrument Error code: 01H, 02H, 03H, 09H, 11H, 12H
47156	03 06 16	R W W	Schedule type	0: Schedule OFF, 1: Date, 2: Day (continuous) Error code: 01H, 02H, 03H, 09H, 11H, 12H
47157	03 06 16	R W W	Starting schedule year	ASCII 2 digits (A space code can be used in the first digit.) 00 to 99 Error code: 01H, 02H, 03H, 09H, 11H, 12H
47158	03 06 16	R W W	Starting schedule month	ASCII 2 digits (A space code can be used in the first digit.) 01 to 12 Error code: 01H, 02H, 03H, 09H, 11H, 12H
47159	03 06 16	R W W	Starting schedule date	ASCII 2 digits (A space code can be used in the first digit.) 01 to 31 Error code: 01H, 02H, 03H, 09H, 11H, 12H
47160	03 06 16	R W W	Starting schedule day	Bit correspondence Bit 0: Sunday, Bit 1: Monday...Bit 6: Saturday ON (1), OFF (0) Error code: 01H, 02H, 03H, 09H, 11H, 12H
47161	03 06 16	R W W	Starting schedule hour	ASCII 2 digits (A space code can be used in the first digit.) 00 to 23 Error code: 01H, 02H, 03H, 09H, 11H, 12H
47162	03 06 16	R W W	Starting schedule minute	ASCII 2 digits (A space code can be used in the first digit.) 00 to 59 Error code: 01H, 02H, 03H, 09H, 11H, 12H
47163	03 06 16	R W W	Ending schedule year	ASCII 2 digits (A space code can be used in the first digit.) 00 to 99 Error code: 01H, 02H, 03H, 09H, 11H, 12H
47164	03 06 16	R W W	Ending schedule month	ASCII 2 digits (A space code can be used in the first digit.) 01 to 12 Error code: 01H, 02H, 03H, 09H, 11H, 12H
47165	03 06 16	R W W	Ending schedule date	ASCII 2 digits (A space code can be used in the first digit.) 01 to 31 Error code: 01H, 02H, 03H, 09H, 11H, 12H
47166	03 06 16	R W W	Ending schedule day	Bit correspondence Bit 0: Sunday, Bit 1: Monday...Bit 6: Saturday ON (1), OFF (0) Error code: 01H, 02H, 03H, 09H, 11H, 12H

Reference number	Applied function code	R/W	Content	Detail
47167	03 06 16	R W W	Ending schedule hour	ASCII 2 digits (A space code can be used in the first digit.) 00 to 23 Error code: 01H, 02H, 03H, 09H, 11H, 12H

8-4-7 File-related-parameter

R/W ... R: READ, W: WRITE

Reference number	Applied function code	R/W	Content	Detail
47207	03 06 16	R W W	File 1 Data recording cycle	0: 0.1 sec., 1: 0.2 sec., 2: 0.5 sec., 3: 1 sec., 4: 2 sec., 5: 3 sec., 6: 5 sec., 7: 10 sec., 8: 15 sec., 9: 20 sec., 0: 30 sec., 11: 1 min., 12: 2 min., 13: 3 min., 14: 5 min., 15: 10 min., 16: 15 min., 17: 20 min., 18: 30 min., 19: 60 min. Error code: 01H, 02H, 03H, 09H, 11H, 12H
47208	03 06 16	R W W	File 1 Start trigger	0: Key, 1: Alarm, 2: Contact input Error code: 01H, 02H, 03H, 09H, 11H, 12H
47209	03 06 16	R W W	File 1 Start condition 1	ASCII 2 digits 47208: The start trigger of File 1 is; 1: In case of alarm, 01 to Alarm output 2: In case of contact input, 01 to Number of remote contact Error code: 01H, 02H, 03H, 09H, 11H, 12H
47210	03 06 16	R W W	File 1 Start condition 2	Number of pre-trigger: 0 to 950 Error code: 01H, 02H, 03H, 09H, 11H, 12H
47211	03 06 16	R W W	File 1 End trigger	0: Same as Start trigger, 1: Period(sec.) Error code: 01H, 02H, 03H, 09H, 11H, 12H
47213	03 06 16	R W W	File 1 End condition	Count: 10 to 30000 Error code: 01H, 02H, 03H, 09H, 11H, 12H
47221	03 06 16	R W W	Storing type	0: Binary (setting information existed), 1: CSV 2: CSV(continue) Error code: 01H, 02H, 03H, 09H, 11H, 12H
47222	03 06 16	R W W	CF saving cycle	0: None, 1: 1 min., 2: 2 min., 3: 3 min., 4: 5 min., 5: 10 min., 6: 20 min., 7: 30 min., 8: 60 min. Error code: 01H, 02H, 03H, 09H, 11H, 12H
47223	03 06 16	R W W	Data type	0: Sample, 1: Average, 2: Maximum, 3: Minimum, 4: Maximum/minimum Error code: 01H, 02H, 03H, 09H, 11H, 12H
47224	03 06 16	R W W	File size	0: Automatic (same as at present) 1: 10 min., 2: 15 min., 3: 20 min., 4: 30 min., 5: 60 min., 6: 2 hours, 7: 3 hours, 8: 4 hours, 9: 6 hours, 10: 8 hours, 11: 12 hours, 12: 24 hours, 13: 1 week, 14: 1 month Error code: 01H, 02H, 03H, 09H, 11H, 12H
47231	03 06 16	R W W	Storing file directory 1, 2	ASCII 2 digits Error code: 01H, 02H, 03H, 09H, 11H, 12H
47232	03 06 16	R W W	Storing file directory 3, 4	ASCII 2 digits Error code: 01H, 02H, 03H, 09H, 11H, 12H

Reference number	Applied function code	R/W	Content	Detail
47233	03 06 16	R W W	Storing file directory 5, 6	ASCII 2 digits Error code: 01H, 02H, 03H, 09H, 11H, 12H
47234	03 06 16	R W W	Storing file directory 7, 8	ASCII 2 digits Error code: 01H, 02H, 03H, 09H, 11H, 12H
47235	03 06 16	R W W	Storing file directory 9, 10	ASCII 2 digits Error code: 01H, 02H, 03H, 09H, 11H, 12H
47236	03 06 16	R W W	Storing file directory 11, 12	ASCII 2 digits Error code: 01H, 02H, 03H, 09H, 11H, 12H
47237	03 06 16	R W W	Storing file directory 13, 14	ASCII 2 digits Error code: 01H, 02H, 03H, 09H, 11H, 12H
47238	03 06 16	R W W	Storing file directory 15, 16	ASCII 2 digits Error code: 01H, 02H, 03H, 09H, 11H, 12H
47241	03 06 16	R W W	Record ON/OFF	0: Record OFF, 1: Record ON Error code: 01H, 02H, 03H, 09H, 11H, 12H
47307 to 47400	03 06 16	R W W	File 2 setting	Same as File 1 parameter (47207 to 47300)
47407 to 47500	03 06 16	R W W	File 3 setting	Same as File 1 parameter (47207 to 47300)
47507 to 47600	03 06 16	R W W	File 4 setting	Same as File 1 parameter (47207 to 47300)
47607 to 47700	03 06 16	R W W	File 5 setting	Same as File 1 parameter (47207 to 47300)
47707 to 47800	03 06 16	R W W	File 6 setting	Same as File 1 parameter (47207 to 47300)

8-4-8 Marker text

R/W ... R: READ, W: WRITE

Reference number	Applied function code	R/W	Content	Detail
48001	03 06 16	R W W	Marker text/ Designation of group number for writing	0 to 5, 00H: Group designation in displaying Error code: 01H, 02H, 03H, 09H, 11H, 12H
48002	03 06 16	R W W	Marker text/ Designation of writing text number	0 to 50, 00H: Designation of text performed last time Error code: 01H, 02H, 03H, 09H, 11H, 12H
48003	03 06 16	R W W	Marker text 1 1, 2	ASCII, Shift JIS 2 digits Error code: 01H, 02H, 03H, 09H, 11H, 12H
48004	03 06 16	R W W	Marker text 1 3, 4	ASCII, Shift JIS 2 digits Error code: 01H, 02H, 03H, 09H, 11H, 12H
48005	03 06 16	R W W	Marker text 1 5, 6	ASCII, Shift JIS 2 digits Error code: 01H, 02H, 03H, 09H, 11H, 12H
48006	03 06 16	R W W	Marker text 1 7, 8	ASCII, Shift JIS 2 digits Error code: 01H, 02H, 03H, 09H, 11H, 12H
48007	03 06 16	R W W	Marker text 1 9, 10	ASCII, Shift JIS 2 digits Error code: 01H, 02H, 03H, 09H, 11H, 12H
48008	03 06 16	R W W	Marker text 1 11, 12	ASCII, Shift JIS 2 digits Error code: 01H, 02H, 03H, 09H, 11H, 12H
48009	03 06 16	R W W	Marker text 1 13, 14	ASCII, Shift JIS 2 digits Error code: 01H, 02H, 03H, 09H, 11H, 12H
48010	03 06 16	R W W	Marker text 1 15, 16	ASCII, Shift JIS 2 digits Error code: 01H, 02H, 03H, 09H, 11H, 12H
48011	03 06 16	R W W	Marker text 1 17, 18	ASCII, Shift JIS 2 digits Error code: 01H, 02H, 03H, 09H, 11H, 12H
48012	03 06 16	R W W	Marker text 1 19, 20	ASCII, Shift JIS 2 digits Error code: 01H, 02H, 03H, 09H, 11H, 12H
48013	03 06 16	R W W	Marker text 1 21, 22	ASCII, Shift JIS 2 digits Error code: 01H, 02H, 03H, 09H, 11H, 12H
48014	03 06 16	R W W	Marker text 1 23, 24	ASCII, Shift JIS 2 digits Error code: 01H, 02H, 03H, 09H, 11H, 12H

Reference number	Applied function code	R/W	Content	Detail
48015	03 06 16	R W W	Marker text 1 25, 26	ASCII, Shift JIS 2 digits Error code: 01H, 02H, 03H, 09H, 11H, 12H
48016	03 06 16	R W W	Marker text 1 27, 28	ASCII, Shift JIS 2 digits Error code: 01H, 02H, 03H, 09H, 11H, 12H
48017	03 06 16	R W W	Marker text 1 29, 30	ASCII, Shift JIS 2 digits Error code: 01H, 02H, 03H, 09H, 11H, 12H
48018 to 48032	03 06 16	R W W	Marker text 2	Same as Marker text 1 (48003 to 48017)
48033 to 48047	03 06 16	R W W	Marker text 3	Same as Marker text 1 (48003 to 48017)
48048 to 48062	03 06 16	R W W	Marker text 4	Same as Marker text 1 (48003 to 48017)
48063 to 48077	03 06 16	R W W	Marker text 5	Same as Marker text 1 (48003 to 48017)
48078 to 48092	03 06 16	R W W	Marker text 6	Same as Marker text 1 (48003 to 48017)
48093 to 48107	03 06 16	R W W	Marker text 7	Same as Marker text 1 (48003 to 48017)
48108 to 48122	03 06 16	R W W	Marker text 8	Same as Marker text 1 (48003 to 48017)
48123 to 48137	03 06 16	R W W	Marker text 9	Same as Marker text 1 (48003 to 48017)
48138 to 48152	03 06 16	R W W	Marker text 10	Same as Marker text 1 (48003 to 48017)
48153 to 48167	03 06 16	R W W	Marker text 11	Same as Marker text 1 (48003 to 48017)
48168 to 48182	03 06 16	R W W	Marker text 12	Same as Marker text 1 (48003 to 48017)
48183 to 48197	03 06 16	R W W	Marker text 13	Same as Marker text 1 (48003 to 48017)
48198 to 48212	03 06 16	R W W	Marker text 14	Same as Marker text 1 (48003 to 48017)

Reference number	Applied function code	R/W	Content	Detail
48213 to 48227	03 06 16	R W W	Marker text 15	Same as Marker text 1 (48003 to 48017)
48228 to 48242	03 06 16	R W W	Marker text 16	Same as Marker text 1 (48003 to 48017)
48243 to 48257	03 06 16	R W W	Marker text 17	Same as Marker text 1 (48003 to 48017)
48258 to 48272	03 06 16	R W W	Marker text 18	Same as Marker text 1 (48003 to 48017)
48273 to 48287	03 06 16	R W W	Marker text 19	Same as Marker text 1 (48003 to 48017)
48288 to 48302	03 06 16	R W W	Marker text 20	Same as Marker text 1 (48003 to 48017)
48303 to 48317	03 06 16	R W W	Marker text 21	Same as Marker text 1 (48003 to 48017)
48318 to 48332	03 06 16	R W W	Marker text 22	Same as Marker text 1 (48003 to 48017)
48333 to 48347	03 06 16	R W W	Marker text 23	Same as Marker text 1 (48003 to 48017)
48348 to 48362	03 06 16	R W W	Marker text 24	Same as Marker text 1 (48003 to 48017)
48363 to 48377	03 06 16	R W W	Marker text 25	Same as Marker text 1 (48003 to 48017)
48378 to 48392	03 06 16	R W W	Marker text 26	Same as Marker text 1 (48003 to 48017)
48393 to 48407	03 06 16	R W W	Marker text 27	Same as Marker text 1 (48003 to 48017)
48408 to 48422	03 06 16	R W W	Marker text 28	Same as Marker text 1 (48003 to 48017)
48423 to 48437	03 06 16	R W W	Marker text 29	Same as Marker text 1 (48003 to 48017)
48438 to 48452	03 06 16	R W W	Marker text 30	Same as Marker text 1 (48003 to 48017)

Reference number	Applied function code	R/W	Content	Detail
48453 to 48467	03 06 16	R W W	Marker text 31	Same as Marker text 1 (48003 to 48017)
48468 to 48482	03 06 16	R W W	Marker text 32	Same as Marker text 1 (48003 to 48017)
48483 to 48497	03 06 16	R W W	Marker text 33	Same as Marker text 1 (48003 to 48017)
48498 to 48512	03 06 16	R W W	Marker text 34	Same as Marker text 1 (48003 to 48017)
48513 to 48527	03 06 16	R W W	Marker text 35	Same as Marker text 1 (48003 to 48017)
48528 to 48542	03 06 16	R W W	Marker text 36	Same as Marker text 1 (48003 to 48017)
48543 to 48557	03 06 16	R W W	Marker text 37	Same as Marker text 1 (48003 to 48017)
48558 to 48572	03 06 16	R W W	Marker text 38	Same as Marker text 1 (48003 to 48017)
48573 to 48587	03 06 16	R W W	Marker text 39	Same as Marker text 1 (48003 to 48017)
48588 to 48602	03 06 16	R W W	Marker text 40	Same as Marker text 1 (48003 to 48017)
48603 to 48617	03 06 16	R W W	Marker text 41	Same as Marker text 1 (48003 to 48017)
48618 to 48632	03 06 16	R W W	Marker text 42	Same as Marker text 1 (48003 to 48017)
48633 to 48647	03 06 16	R W W	Marker text 43	Same as Marker text 1 (48003 to 48017)
48648 to 48662	03 06 16	R W W	Marker text 44	Same as Marker text 1 (48003 to 48017)
48663 to 48677	03 06 16	R W W	Marker text 45	Same as Marker text 1 (48003 to 48017)
48678 to 48692	03 06 16	R W W	Marker text 46	Same as Marker text 1 (48003 to 48017)

Reference number	Applied function code	R/W	Content	Detail
48693 to 48707	03 06 16	R W W	Marker text 47	Same as Marker text 1 (48003 to 48017)
48708 to 48722	03 06 16	R W W	Marker text 48	Same as Marker text 1 (48003 to 48017)
48723 to 48737	03 06 16	R W W	Marker text 49	Same as Marker text 1 (48003 to 48017)
48738 to 48752	03 06 16	R W W	Marker text 50	Same as Marker text 1 (48003 to 48017)
48901	03 06 16	R W W	Marker text 1 DI-No./Group No.	Bit 8 to 15 DI-No: 1 to Number of remote contact, 0: Not set Bit 0 to 7 Group No: 1 to Maximum group number Error code: 01H, 02H, 03H, 09H, 11H, 12H
48902	03 06 16	R W W	Marker text 2 DI-No./Group No.	Bit 8 to 15 DI-No: 1 to Number of remote contact, 0: Not set Bit 0 to 7 Group No: 1 to Maximum group number Error code: 01H, 02H, 03H, 09H, 11H, 12H
48903	03 06 16	R W W	Marker text 3 DI-No./Group No.	Bit8 to 15 DI-No: 1 to Number of remote contact, 0: Not set Bit0 to 7 Group No: 1 to Maximum group number Error code: 01H, 02H, 03H, 09H, 11H, 12H
48904	03 06 16	R W W	Marker text 4 DI-No./Group No.	Bit8 to 15 DI-No: 1 to Number of remote contact, 0: Not set Bit0 to 7 Group No: 1 to Maximum group number Error code: 01H, 02H, 03H, 09H, 11H, 12H
48905	03 06 16	R W W	Marker text 5 DI-No./Group No.	Bit8 to 15 DI-No: 1 to Number of remote contact, 0: Not set Bit0 to 7 Group No: 1 to Maximum group number Error code: 01H, 02H, 03H, 09H, 11H, 12H
48906	03 06 16	R W W	Marker text 6 DI-No./Group No.	Bit8 to 15 DI-No: 1 to Number of remote contact, 0: Not set Bit0 to 7 Group No: 1 to Maximum group number Error code: 01H, 02H, 03H, 09H, 11H, 12H
48907	03 06 16	R W W	Marker text 7 DI-No./Group No.	Bit8 to 15 DI-No: 1 to Number of remote contact, 0: Not set Bit0 to 7 Group No: 1 to Maximum group number Error code: 01H, 02H, 03H, 09H, 11H, 12H

Reference number	Applied function code	R/W	Content	Detail
48908	03 06 16	R W W	Marker text 8 DI-No./Group No.	Bit8 to 15 DI-No: 1 to Number of remote contact, 0: Not set Bit0 to 7 Group No: 1 to Maximum group number Error code: 01H, 02H, 03H, 09H, 11H, 12H
48909	03 06 16	R W W	Marker text 9 DI-No./Group No.	Bit8 to 15 DI-No: 1 to Number of remote contact, 0: Not set Bit0 to 7 Group No: 1 to Maximum group number Error code: 01H, 02H, 03H, 09H, 11H, 12H
48910	03 06 16	R W W	Marker text 10 DI-No./Group No.	Bit8 to 15 DI-No: 1 to Number of remote contact, 0: Not set Bit0 to 7 Group No: 1 to Maximum group number Error code: 01H, 02H, 03H, 09H, 11H, 12H
48911	03 06 16	R W W	Marker text 11 DI-No./Group No.	Bit8 to 15 DI-No: 1 to Number of remote contact, 0: Not set Bit0 to 7 Group No: 1 to Maximum group number Error code: 01H, 02H, 03H, 09H, 11H, 12H
48912	03 06 16	R W W	Marker text 12 DI-No./Group No.	Bit8 to 15 DI-No: 1 to Number of remote contact, 0: Not set Bit0 to 7 Group No: 1 to Maximum group number Error code: 01H, 02H, 03H, 09H, 11H, 12H
48913	03 06 16	R W W	Marker text 13 DI-No./Group No.	Bit8 to 15 DI-No: 1 to Number of remote contact, 0: Not set Bit0 to 7 Group No: 1 to Maximum group number Error code: 01H, 02H, 03H, 09H, 11H, 12H
48914	03 06 16	R W W	Marker text 14 DI-No./Group No.	Bit8 to 15 DI-No: 1 to Number of remote contact, 0: Not set Bit0 to 7 Group No: 1 to Maximum group number Error code: 01H, 02H, 03H, 09H, 11H, 12H
48915	03 06 16	R W W	Marker text 15 DI-No./Group No.	Bit8 to 15 DI-No: 1 to Number of remote contact, 0: Not set Bit0 to 7 Group No: 1 to Maximum group number Error code: 01H, 02H, 03H, 09H, 11H, 12H
48916	03 06 16	R W W	Marker text 16 DI-No./Group No.	Bit8 to 15 DI-No: 1 to Number of remote contact, 0: Not set Bit0 to 7 Group No: 1 to Maximum group number Error code: 01H, 02H, 03H, 09H, 11H, 12H
48917	03 06 16	R W W	Marker text 17 DI-No./Group No.	Bit8 to 15 DI-No: 1 to Number of remote contact, 0: Not set Bit0 to 7 Group No: 1 to Maximum group number Error code: 01H, 02H, 03H, 09H, 11H, 12H

Reference number	Applied function code	R/W	Content	Detail
48918	03 06 16	R W W	Marker text 18 DI-No./Group No.	Bit8 to 15 DI-No: 1 to Number of remote contact, 0: Not set Bit0 to 7 Group No: 1 to Maximum group number Error code: 01H, 02H, 03H, 09H, 11H, 12H
48919	03 06 16	R W W	Marker text 19 DI-No./Group No.	Bit8 to 15 DI-No: 1 to Number of remote contact, 0: Not set Bit0 to 7 Group No: 1 to Maximum group number Error code: 01H, 02H, 03H, 09H, 11H, 12H
48920	03 06 16	R W W	Marker text 20 DI-No./Group No.	Bit8 to 15 DI-No: 1 to Number of remote contact, 0: Not set Bit0 to 7 Group No: 1 to Maximum group number Error code: 01H, 02H, 03H, 09H, 11H, 12H
48921	03 06 16	R W W	Marker text 21 DI-No./Group No.	Bit8 to 15 DI-No: 1 to Number of remote contact, 0: Not set Bit0 to 7 Group No: 1 to Maximum group number Error code: 01H, 02H, 03H, 09H, 11H, 12H
48922	03 06 16	R W W	Marker text 22 DI-No./Group No.	Bit8 to 15 DI-No: 1 to Number of remote contact, 0: Not set Bit0 to 7 Group No: 1 to Maximum group number Error code: 01H, 02H, 03H, 09H, 11H, 12H
48923	03 06 16	R W W	Marker text 23 DI-No./Group No.	Bit8 to 15 DI-No: 1 to Number of remote contact, 0: Not set Bit0 to 7 Group No: 1 to Maximum group number Error code: 01H, 02H, 03H, 09H, 11H, 12H
48924	03 06 16	R W W	Marker text 24 DI-No./Group No.	Bit8 to 15 DI-No: 1 to Number of remote contact, 0: Not set Bit0 to 7 Group No: 1 to Maximum group number Error code: 01H, 02H, 03H, 09H, 11H, 12H
48925	03 06 16	R W W	Marker text 25 DI-No./Group No.	Bit8 to 15 DI-No: 1 to Number of remote contact, 0: Not set Bit0 to 7 Group No: 1 to Maximum group number Error code: 01H, 02H, 03H, 09H, 11H, 12H
48926	03 06 16	R W W	Marker text 26 DI-No./Group No.	Bit8 to 15 DI-No: 1 to Number of remote contact, 0: Not set Bit0 to 7 Group No: 1 to Maximum group number Error code: 01H, 02H, 03H, 09H, 11H, 12H
48927	03 06 16	R W W	Marker text 27 DI-No./Group No.	Bit8 to 15 DI-No: 1 to Number of remote contact, 0: Not set Bit0 to 7 Group No: 1 to Maximum group number Error code: 01H, 02H, 03H, 09H, 11H, 12H

Reference number	Applied function code	R/W	Content	Detail
48928	03 06 16	R W W	Marker text 28 DI-No./Group No.	Bit8 to 15 DI-No: 1 to Number of remote contact, 0: Not set Bit0 to 7 Group No: 1 to Maximum group number Error code: 01H, 02H, 03H, 09H, 11H, 12H
48929	03 06 16	R W W	Marker text 29 DI-No./Group No.	Bit8 to 15 DI-No: 1 to Number of remote contact, 0: Not set Bit0 to 7 Group No: 1 to Maximum group number Error code: 01H, 02H, 03H, 09H, 11H, 12H
48930	03 06 16	R W W	Marker text 30 DI-No./Group No.	Bit8 to 15 DI-No: 1 to Number of remote contact, 0: Not set Bit0 to 7 Group No: 1 to Maximum group number Error code: 01H, 02H, 03H, 09H, 11H, 12H
48931	03 06 16	R W W	Marker text 31 DI-No./Group No.	Bit8 to 15 DI-No: 1 to Number of remote contact, 0: Not set Bit0 to 7 Group No: 1 to Maximum group number Error code: 01H, 02H, 03H, 09H, 11H, 12H
48932	03 06 16	R W W	Marker text 32 DI-No./Group No.	Bit8 to 15 DI-No: 1 to Number of remote contact, 0: Not set Bit0 to 7 Group No: 1 to Maximum group number Error code: 01H, 02H, 03H, 09H, 11H, 12H
48933	03 06 16	R W W	Marker text 33 DI-No./Group No.	Bit8 to 15 DI-No: 1 to Number of remote contact, 0: Not set Bit0 to 7 Group No: 1 to Maximum group number Error code: 01H, 02H, 03H, 09H, 11H, 12H
48934	03 06 16	R W W	Marker text 34 DI-No./Group No.	Bit8 to 15 DI-No: 1 to Number of remote contact, 0: Not set Bit0 to 7 Group No: 1 to Maximum group number Error code: 01H, 02H, 03H, 09H, 11H, 12H
48935	03 06 16	R W W	Marker text 35 DI-No./Group No.	Bit8 to 15 DI-No: 1 to Number of remote contact, 0: Not set Bit0 to 7 Group No: 1 to Maximum group number Error code: 01H, 02H, 03H, 09H, 11H, 12H
48936	03 06 16	R W W	Marker text 36 DI-No./Group No.	Bit8 to 15 DI-No: 1 to Number of remote contact, 0: Not set Bit0 to 7 Group No: 1 to Maximum group number Error code: 01H, 02H, 03H, 09H, 11H, 12H
48937	03 06 16	R W W	Marker text 37 DI-No./Group No.	Bit8 to 15 DI-No: 1 to Number of remote contact, 0: Not set Bit0 to 7 Group No: 1 to Maximum group number Error code: 01H, 02H, 03H, 09H, 11H, 12H

Reference number	Applied function code	R/W	Content	Detail
48938	03 06 16	R W W	Marker text 38 DI-No./Group No.	Bit8 to 15 DI-No: 1 to Number of remote contact, 0: Not set Bit0 to 7 Group No: 1 to Maximum group number Error code: 01H, 02H, 03H, 09H, 11H, 12H
48939	03 06 16	R W W	Marker text 39 DI-No./Group No.	Bit8 to 15 DI-No: 1 to Number of remote contact, 0: Not set Bit0 to 7 Group No: 1 to Maximum group number Error code: 01H, 02H, 03H, 09H, 11H, 12H
48940	03 06 16	R W W	Marker text 40 DI-No./Group No.	Bit8 to 15 DI-No: 1 to Number of remote contact, 0: Not set Bit0 to 7 Group No: 1 to Maximum group number Error code: 01H, 02H, 03H, 09H, 11H, 12H
48941	03 06 16	R W W	Marker text 41 DI-No./Group No.	Bit8 to 15 DI-No: 1 to Number of remote contact, 0: Not set Bit0 to 7 Group No: 1 to Maximum group number Error code: 01H, 02H, 03H, 09H, 11H, 12H
48942	03 06 16	R W W	Marker text 42 DI-No./Group No.	Bit8 to 15 DI-No: 1 to Number of remote contact, 0: Not set Bit0 to 7 Group No: 1 to Maximum group number Error code: 01H, 02H, 03H, 09H, 11H, 12H
48943	03 06 16	R W W	Marker text 43 DI-No./Group No.	Bit8 to 15 DI-No: 1 to Number of remote contact, 0: Not set Bit0 to 7 Group No: 1 to Maximum group number Error code: 01H, 02H, 03H, 09H, 11H, 12H
48944	03 06 16	R W W	Marker text 44 DI-No./Group No.	Bit8 to 15 DI-No: 1 to Number of remote contact, 0: Not set Bit0 to 7 Group No: 1 to Maximum group number Error code: 01H, 02H, 03H, 09H, 11H, 12H
48945	03 06 16	R W W	Marker text 45 DI-No./Group No.	Bit8 to 15 DI-No: 1 to Number of remote contact, 0: Not set Bit0 to 7 Group No: 1 to Maximum group number Error code: 01H, 02H, 03H, 09H, 11H, 12H
48946	03 06 16	R W W	Marker text 46 DI-No./Group No.	Bit8 to 15 DI-No: 1 to Number of remote contact, 0: Not set Bit0 to 7 Group No: 1 to Maximum group number Error code: 01H, 02H, 03H, 09H, 11H, 12H
48947	03 06 16	R W W	Marker text 47 DI-No./Group No.	Bit8 to 15 DI-No: 1 to Number of remote contact, 0: Not set Bit0 to 7 Group No: 1 to Maximum group number Error code: 01H, 02H, 03H, 09H, 11H, 12H

Reference number	Applied function code	R/W	Content	Detail
48948	03 06 16	R W W	Marker text 48 DI-No./Group No.	Bit8 to 15 DI-No: 1 to Number of remote contact, 0: Not set Bit0 to 7 Group No: 1 to Maximum group number Error code: 01H, 02H, 03H, 09H, 11H, 12H
48949	03 06 16	R W W	Marker text 49 DI-No./Group No.	Bit8 to 15 DI-No: 1 to Number of remote contact, 0: Not set Bit0 to 7 Group No: 1 to Maximum group number Error code: 01H, 02H, 03H, 09H, 11H, 12H
48950	03 06 16	R W W	Marker text 50 DI-No./Group No.	Bit8 to 15 DI-No: 1 to Number of remote contact, 0: Not set Bit0 to 7 Group No: 1 to Maximum group number Error code: 01H, 02H, 03H, 09H, 11H, 12H

8-4-9 Low order communication setting (PLC relation)

R/W ... R: READ, W: WRITE

Reference number	Applied function code	R/W	Content	Detail
48951	03 06 16	R W W	PLC node number 1	Node number of connection PLC: 0 to 31 Error code: 01H, 02H, 03H, 09H, 11H, 12H
48952	03 06 16	R W W	PLC node number 2	Node number of connection PLC: 0 to 31 Error code: 01H, 02H, 03H, 09H, 11H, 12H
48953	03 06 16	R W W	PLC node number 3	Node number of connection PLC: 0 to 31 Error code: 01H, 02H, 03H, 09H, 11H, 12H
48954	03 06 16	R W W	PLC node number 4	Node number of connection PLC: 0 to 31 Error code: 01H, 02H, 03H, 09H, 11H, 12H
48955	03 06 16	R W W	PLC node number 5	Node number of connection PLC: 0 to 31 Error code: 01H, 02H, 03H, 09H, 11H, 12H
48956	03 06 16	R W W	Top address 1 of PLC 1,2	Top address of connection PLC ASCII code 2 digits Error code: 01H, 02H, 03H, 09H, 11H, 12H
48957	03 06 16	R W W	Top address 1 of PLC 3,4	Top address of connection PLC ASCII code 2 digits Error code: 01H, 02H, 03H, 09H, 11H, 12H
48958	03 06 16	R W W	Top address 1 of PLC 5,6	Top address of connection PLC ASCII 1 digit, Low 1 byte - 00H fixed Error code: 01H, 02H, 03H, 09H, 11H, 12H
48960 to 48962	03 06 16	R W W	Top address 2 of PLC	Same as top address 1 of PLC (48956 to 48958)
48964 to 48966	03 06 16	R W W	Top address 3 of PLC	Same as top address 1 of PLC (48956 to 48958)
48968 to 48970	03 06 16	R W W	Top address 4 of PLC	Same as top address 1 of PLC (48956 to 48958)
48972 to 48974	03 06 16	R W W	Top address 5 of PLC	Same as top address 1 of PLC (48956 to 48958)

Reference number	Applied function code	R/W	Content	Detail
48976	03 06 16	R W W	PLC read / write count 1	Low order communication (read) : read count For MELSEC 1 to 60 For SYSMAC 1 to 30 Low order communication (write) : write count For MELSEC 1 to 64 For SYSMAC 1 to 29 Error code: 01H, 02H, 03H, 09H, 11H, 12H
48977	03 06 16	R W W	PLC read / write count 2	Same as PLC read / write count 1 (48976)
48978	03 06 16	R W W	PLC read / write count 3	Same as PLC read / write count 1 (48976)
48979	03 06 16	R W W	PLC read / write count 4	Same as PLC read / write count 1 (48976)
48980	03 06 16	R W W	PLC read / write count 5	Same as PLC read / write count 1 (48976)
48981	03 06 16	R W W	PLC writing KR Top CH 1	Low order communication use (write) <KR2S>1 to 44, <KR3S>1 to 128 Error code: 01H, 02H, 03H, 09H, 11H, 12H
48982	03 06 16	R W W	PLC writing KR Top CH 2	Low order communication use (write) <KR2S>1 to 44, <KR3S>1 to 128 Error code: 01H, 02H, 03H, 09H, 11H, 12H
48983	03 06 16	R W W	PLC writing KR Top CH 3	Low order communication use (write) <KR2S>1 to 44, <KR3S>1 to 128 Error code: 01H, 02H, 03H, 09H, 11H, 12H
48984	03 06 16	R W W	PLC writing KR Top CH 4	Low order communication use (write) <KR2S>1 to 44, <KR3S>1 to 128 Error code: 01H, 02H, 03H, 09H, 11H, 12H
48985	03 06 16	R W W	PLC writing KR Top CH 5	Low order communication use (write) <KR2S>1 to 44, <KR3S>1 to 128 Error code: 01H, 02H, 03H, 09H, 11H, 12H

8-4-10 Web server setting

R/W ... R: READ, W: WRITE

Reference number	Applied function code	R/W	Content	Detail
49001	03	R	Web server	ASCII, Shift JIS 2 digit Error code: 01H, 02H, 03H, 09H, 11H, 12H
	06	W	Administrator user	
	16	W	User name 1,2	
49002	03	R	Web server	ASCII, Shift JIS 2 digit Error code: 01H, 02H, 03H, 09H, 11H, 12H
	06	W	Administrator user	
	16	W	User name 3,4	
49003	03	R	Web server	ASCII, Shift JIS 2 digit Error code: 01H, 02H, 03H, 09H, 11H, 12H
	06	W	Administrator user	
	16	W	User name 5,6	
49004	03	R	Web server	ASCII, Shift JIS 2 digit Error code: 01H, 02H, 03H, 09H, 11H, 12H
	06	W	Administrator user	
	16	W	User name 7,8	
49005	03	R	Web server	ASCII, Shift JIS 2 digit Error code: 01H, 02H, 03H, 09H, 11H, 12H
	06	W	Administrator user	
	16	W	User name 9,10	
49006	03	R	Web server	ASCII, Shift JIS 2 digit Error code: 01H, 02H, 03H, 09H, 11H, 12H
	06	W	Administrator user	
	16	W	User name 11,12	
49007	03	R	Web server	ASCII, Shift JIS 2 digit Error code: 01H, 02H, 03H, 09H, 11H, 12H
	06	W	Administrator user	
	16	W	User name 13,14	
49008	03	R	Web server	ASCII, Shift JIS 2 digit Error code: 01H, 02H, 03H, 09H, 11H, 12H
	06	W	Administrator user	
	16	W	User name 15,16	
49009	03	R	Web server	ASCII, Shift JIS 2 digit Error code: 01H, 02H, 03H, 09H, 11H, 12H
	06	W	Administrator user	
	16	W	User name 17,18	
49010	03	R	Web server	ASCII, Shift JIS 2 digit Error code: 01H, 02H, 03H, 09H, 11H, 12H
	06	W	Administrator user	
	16	W	User name 19,20	
49011	03	R	Web server	ASCII, Shift JIS 2 digit Error code: 01H, 02H, 03H, 09H, 11H, 12H
	06	W	Administrator user	
	16	W	User name 21,22	
49012	03	R	Web server	ASCII, Shift JIS 2 digit Error code: 01H, 02H, 03H, 09H, 11H, 12H
	06	W	Administrator user	
	16	W	User name 23,24	
49013	03	R	Web server	ASCII, Shift JIS 2 digit Error code: 01H, 02H, 03H, 09H, 11H, 12H
	06	W	Administrator user	
	16	W	User name 25,26	
49014	03	R	Web server	ASCII, Shift JIS 2 digit Error code: 01H, 02H, 03H, 09H, 11H, 12H
	06	W	Administrator user	
	16	W	User name 27,28	
49015	03	R	Web server	ASCII, Shift JIS 2 digit Error code: 01H, 02H, 03H, 09H, 11H, 12H
	06	W	Administrator user	
	16	W	User name 29,30	

Reference number	Applied function code	R/W	Content	Detail
49016	03 06 16	R W W	Web server Administrator user User name 31,32	ASCII, Shift JIS 2 digit Error code: 01H, 02H, 03H, 09H, 11H, 12H
49017 to 49032	03 06 16	R W W	Web server Administrator user Password 1 to 32	Same as administrator user name (49001 to 49016)
49033 to 49048	03 06 16	R W W	Web server General user User name 1 to 32	Same as administrator user name (49001 to 49016)
49049 to 49064	03 06 16	R W W	Web server General user Password 1 to 32	Same as administrator user name (49001 to 49016)

8-5 Analog setting values(Only KR3S)

8-5-1 Setting parameters for each channel (from CH50)

(Note) Writing of multiple setting values across channels becomes an error.(Error code 12H)

Reference number	Applied function code	R/W	Content	Detail
50002	60 61	R W	CH50 range number	ASCII code 2 digits (A space code can be used in the first digit.) After CH50: If low order communication is registered, same as range number of connected instrument, otherwise 10 (-10.00 to 10.00V) fixed For the optional DI added CH37 to CH42: 90 (DI) to 92 (pulse (-)) Error code: 01H, 02H, 03H, 09H, 11H, 12H
50003	60 61	R W	CH50 RJ	0: External, 1: Internal * For other than thermocouple inputs "0: External" fixed Error code: 01H, 02H, 03H, 09H, 11H, 12H
50004	60 61	R W	CH50 range low limit	-30000 to 30000 Error code: 01H, 02H, 03H, 09H, 11H, 12H
50005	60 61	R W	CH50 range high limit	-30000 to 30000 Error code: 01H, 02H, 03H, 09H, 11H, 12H
50006	60 61	R W	CH50 range decimal point	Range decimal place 0 to 3 *Same decimal place for range high/low limits values Error code: 01H, 02H, 03H, 09H, 11H, 12H
50007	60 61	R W	CH50 scale low limit	-30000 to 30000 Error code: 01H, 02H, 03H, 09H, 11H, 12H
50008	60 61	R W	CH50 scale high limit	-30000 to 30000 Error code: 01H, 02H, 03H, 09H, 11H, 12H
50009	60 61	R W	CH50 scale decimal point	Scale decimal place 0 to 3 *Same decimal place for scale high/low limits values Error code: 01H, 02H, 03H, 09H, 11H, 12H
50010	60 61	R W	CH50 burnout	0: Disable 1: Up scale, 2: Down scale Error code: 01H, 02H, 03H, 09H, 11H, 12H
50011	60 61	R W	CH50 sensor correction	-30000 to 30000 * The scale decimal point is used for the decimal place. Error code: 01H, 02H, 03H, 09H, 11H, 12H
50012	60 61	R W	CH50 display color	KR3000: 48 colors Error code: 01H, 02H, 03H, 09H, 11H, 12H

Reference number	Applied function code	R/W	Content	Detail
50013	03 06 16	R W W	CH50 filter level	0: System setting used 1: [0]none , [1]Weak, [2]Middle, [3]Strong Error code: 01H, 02H, 03H, 09H, 11H, 12H
50014	03 06 16	R W W	CH50 alarm marker 1,2	Higher 1 byte: Alarm marker 1 0 to 50 Lower 1 byte: Alarm marker 2 0 to 50 Error code: 01H, 02H, 03H, 09H, 11H, 12H
50015	03 06 16	R W W	CH50 alarm marker 3,4	Higher 1 byte: Alarm marker 3 0 to 50 Lower 1 byte: Alarm marker 4 0 to 50 Error code: 01H, 02H, 03H, 09H, 11H, 12H
50016	03 06 16	R W W	CH50 totalizer reset By DI	Higher 1byte : Totalizer reset [0] OFF, [1] ON Lower 1byte : Reset by DI : 0 to 8 (Reset is not in 0.) Error code: 01H, 02H, 03H, 09H, 11H, 12H
50017	03 06 16	R W W	CH50 totalizer reset reference hour/minute	Higher 1 byte: hour 0 to 23 Lower 1 byte: minute 0 to 59 Error code: 01H, 02H, 03H, 09H, 11H, 12H
50018	03 06 16	R W W	CH50 totalizer reset interval	Higher 1 byte: hour 0 to 24 Lower 1 byte: minute 0 to 59 Error code: 01H, 02H, 03H, 09H, 11H, 12H
50019	60 61	R W	CH50 unit 1, 2	ASCII, Shift JIS 2 digit Error code: 01H, 02H, 03H, 09H, 11H, 12H
50020	60 61	R W	CH50 unit 3, 4	ASCII, Shift JIS 2 digit Error code: 01H, 02H, 03H, 09H, 11H, 12H
50021	60 61	R W	CH50 unit 5, 6	ASCII 1 digit, Low 1 byte - 00H fixed Error code: 01H, 02H, 03H, 09H, 11H, 12H
50022	60 61	R W	CH50 unit 7	ASCII, Shift JIS 2 digit Error code: 01H, 02H, 03H, 09H, 11H, 12H
50025	60 61	R W	CH50 tag 1, 2	ASCII, Shift JIS 2 digit Error code: 01H, 02H, 03H, 09H, 11H, 12H
50026	60 61	R W	CH50 tag 3, 4	ASCII, Shift JIS 2 digit Error code: 01H, 02H, 03H, 09H, 11H, 12H
50027	60 61	R W	CH50 tag 5, 6	ASCII, Shift JIS 2 digit Error code: 01H, 02H, 03H, 09H, 11H, 12H
50028	60 61	R W	CH50 tag 7, 8	ASCII, Shift JIS 2 digit Error code: 01H, 02H, 03H, 09H, 11H, 12H
50029	60 61	R W	CH50 tag 9, 10	ASCII, Shift JIS 2 digit Error code: 01H, 02H, 03H, 09H, 11H, 12H

Reference number	Applied function code	R/W	Content	Detail
50030	60 61	R W	CH50 tag 11, 12	ASCII, Shift JIS 2 digit Error code: 01H, 02H, 03H, 09H, 11H, 12H
50031	60 61	R W	CH50 tag 13, 14	ASCII, Shift JIS 2 digit Error code: 01H, 02H, 03H, 09H, 11H, 12H
50032	60 61	R W	CH50 tag 15	ASCII 1 digit, Low 1 byte - 00H fixed Error code: 01H, 02H, 03H, 09H, 11H, 12H
50033	60 61	R W	CH50 alarm type 1	0: Disable, 1: High limit, 2: Low limit, 5: Difference high limit, 6: Difference low limit, 7: Abnormal data Error code: 01H, 02H, 03H, 09H, 11H, 12H
50034	60 61	R W	CH50 setting value 1	-30000 to 30000 * The scale decimal point is used for the decimal place. Error code: 01H, 02H, 03H, 09H, 11H, 12H
50035	60 61	R W	CH50 output relay 1	ASCII 2 digits 01 to Alarm output point, 00H: No setting Error code: 01H, 02H, 03H, 09H, 11H, 12H
50036	60 61	R W	CH50 AND/OR 1	0: OR, 1: AND Error code: 01H, 02H, 03H, 09H, 11H, 12H
50037	60 61	R W	CH50 reference channel 1	ASCII 2 digits Reference channel No. at differential alarm 3031H(1),3032H(2),3033H(3),.....,3938H(98),3939H(99),3A30H(100),3A31H(101),.....,3B37H(127),3B38H(128) Error code: 01H,02H,03H, 09H,11H,12H
50039	60 61	R W	CH50 dead band 1	0 to 30000 * The scale decimal point is used for the decimal place. Error code: 01H, 02H, 03H, 09H, 11H, 12H
50040	60 61	R W	CH50 alarm delay 1	0 to 3600 seconds Error code: 01H, 02H, 03H, 09H, 11H, 12H
50041	60 61	R W	CH50 alarm type 2	0: Disable, 1: high limit, 2: Low limit, 5: Difference high limit, 6: Difference low limit, 7: Abnormal data Error code: 01H, 02H, 03H, 09H, 11H, 12H
50042	60 61	R W	CH50 setting value 2	-30000 to 30000 * The scale decimal point is used for the decimal place. Error code: 01H, 02H, 03H, 09H, 11H, 12H
50043	60 61	R W	CH50 output relay 2	ASCII 2 digits 01 to Alarm output point, 00H: No setting Error code: 01H, 02H, 03H, 09H, 11H, 12H

Reference number	Applied function code	R/W	Content	Detail
50044	60 61	R W	CH50 AND/OR 2	0:OR, 1: AND Error code: 01H, 02H, 03H, 09H, 11H, 12H
50045	60 61	R W	CH50 reference channel 2	ASCII 2 digits Reference channel No. at differential alarm 3031H(1),3032H(2),3033H(3),.....,3938H(98),3939H(99),3A30H(100),3A31H(101),.....,3B37H(127),3B38H(128) Error code: 01H,02H,03H, 09H,11H,12H
50047	60 61	R W	CH50 dead band 2	0 to 30000 * The scale decimal point is used for the decimal place. Error code: 01H, 02H, 03H, 09H, 11H, 12H
50048	60 61	R W	CH50 alarm delay 2	0 to 3600 seconds Error code: 01H, 02H, 03H, 09H, 11H, 12H
50049	60 61	R W	CH50 alarm type 3	0: Disable, 1: high limit, 2: Low limit, 5: Difference high limit, 6: Difference low limit, 7: Abnormal data Error code: 01H, 02H, 03H, 09H, 11H, 12H
50050	60 61	R W	CH50 setting value 3	-30000 to 30000 * The scale decimal point is used for the decimal place. Error code: 01H, 02H, 03H, 09H, 11H, 12H
50051	60 61	R W	CH50 output relay 3	ASCII 2 digits 01 to Alarm output point, 00H: No setting Error code: 01H, 02H, 03H, 09H, 11H, 12H
50052	60 61	R W	CH50 AND/OR 3	0:OR, 1: AND Error code: 01H, 02H, 03H, 09H, 11H, 12H
50053	60 61	R W	CH50 reference channel 3	ASCII 2 digits Reference channel No. at differential alarm 3031H(1),3032H(2),3033H(3),.....,3938H(98),3939H(99),3A30H(100),3A31H(101),.....,3B37H(127),3B38H(128) Error code: 01H,02H,03H, 09H,11H,12H
50055	60 61	R W	CH50 dead band 3	0 to 30000 * The scale decimal point is used for the decimal place. Error code: 01H, 02H, 03H, 09H, 11H, 12H
50056	60 61	R W	CH50 alarm delay 3	0 to 3600 seconds Error code: 01H, 02H, 03H, 09H, 11H, 12H
50057	60 61	R W	CH50 alarm type 4	0: Disable, 1: high limit, 2: Low limit, 5: Difference high limit, 6: Difference low limit, 7: Abnormal data Error code: 01H, 02H, 03H, 09H, 11H, 12H
50058	60 61	R W	CH50 setting value 4	-30000 to 30000 * The scale decimal point is used for the decimal place. Error code: 01H, 02H, 03H, 09H, 11H, 12H

Reference number	Applied function code	R/W	Content	Detail
50059	60 61	R W	CH50 output relay 4	ASCII 2 digits 01 to Alarm output point, 00H: No setting Error code: 01H, 02H, 03H, 09H, 11H, 12H
50060	60 61	R W	CH50 AND/OR 4	0:OR, 1: AND Error code: 01H, 02H, 03H, 09H, 11H, 12H
50061	60 61	R W	CH50 reference channel 4	ASCII 2 digits Reference channel No. at differential alarm 3031H(1),3032H(2),3033H(3),.....,3938H(98),3939H(99),3A30H(100),3A31H(101),.....,3B37H(127),3B38H(128) Error code: 01H,02H,03H, 09H,11H,12H
50063	60 61	R W	CH50 dead band 4	0 to 30000 * The scale decimal point is used for the decimal place. Error code: 01H, 02H, 03H, 09H, 11H, 12H
50064	60 61	R W	CH50 alarm delay 4	0 to 3600 seconds Error code: 01H, 02H, 03H, 09H, 11H, 12H
50066	60 61	R W	CH50 display scale low limit	-30000 to 30000 Error code: 01H, 02H, 03H, 09H, 11H, 12H
50067	60 61	R W	CH50 display scale high limit	-30000 to 30000 Error code: 01H, 02H, 03H, 09H, 11H, 12H
50068	60 61	R W	CH50 display scale decimal point	0 to 3 Error code: 01H, 02H, 03H, 09H, 11H, 12H
50069	60 61	R W	CH50 display scale type	0: Standard, 1: Exponent Error code: 01H, 02H, 03H, 09H, 11H, 12H
50071	60 61	R W	CH50 range position (Area belonged)	0 to 3, At parallel scale 0 to 7 (0 to 3: First zone, 4 to 7: Second zone) Error code: 01H, 02H, 03H, 09H, 11H, 12H
50076	60 61	R W	Calculation ON/OFF	0: Not used, 1: Used Error code: 01H, 02H, 03H, 09H, 11H, 12H
50077	60 61	R W	CH50 calculation formula 1, 2	ASCII 2 digits Error code: 01H, 02H, 03H, 09H, 11H, 12H
50078	60 61	R W	CH50 calculation formula 3, 4	ASCII 2 digits Error code: 01H, 02H, 03H, 09H, 11H, 12H
50079	60 61	R W	CH50 calculation formula 5, 6	ASCII 2 digits Error code: 01H, 02H, 03H, 09H, 11H, 12H
50080	60 61	R W	CH50 calculation formula 7, 8	ASCII 2 digits Error code: 01H, 02H, 03H, 09H, 11H, 12H

Reference number	Applied function code	R/W	Content	Detail
50081	60 61	R W	CH50 calculation formula 9, 10	ASCII 2 digits Error code: 01H, 02H, 03H, 09H, 11H, 12H
50082	60 61	R W	CH50 calculation formula 11, 12	ASCII 2 digits Error code: 01H, 02H, 03H, 09H, 11H, 12H
50083	60 61	R W	CH50 calculation formula 13, 14	ASCII 2 digits Error code: 01H, 02H, 03H, 09H, 11H, 12H
50084	60 61	R W	CH50 calculation formula 15, 16	ASCII 2 digits Error code: 01H, 02H, 03H, 09H, 11H, 12H
50085	60 61	R W	CH50 calculation formula 17, 18	ASCII 2 digits Error code: 01H, 02H, 03H, 09H, 11H, 12H
50086	60 61	R W	CH50 calculation formula 19, 20	ASCII 2 digits Error code: 01H, 02H, 03H, 09H, 11H, 12H
50087	60 61	R W	CH50 calculation formula 21, 22	ASCII 2 digits Error code: 01H, 02H, 03H, 09H, 11H, 12H
50088	60 61	R W	CH50 calculation formula 23, 24	ASCII 2 digits Error code: 01H, 02H, 03H, 09H, 11H, 12H
50089	60 61	R W	CH50 calculation formula 25, 26	ASCII 2 digits Error code: 01H, 02H, 03H, 09H, 11H, 12H
50090	60 61	R W	CH50 calculation formula 27, 28	ASCII 2 digits Error code: 01H, 02H, 03H, 09H, 11H, 12H
50091	60 61	R W	CH50 calculation formula 29, 30	ASCII 2 digits Error code: 01H, 02H, 03H, 09H, 11H, 12H
50092	60 61	R W	CH50 calculation formula 31, 32	ASCII 2 digits Error code: 01H, 02H, 03H, 09H, 11H, 12H
50093	60 61	R W	CH50 calculation formula 33, 34	ASCII 2 digits Error code: 01H, 02H, 03H, 09H, 11H, 12H
50094	60 61	R W	CH50 calculation formula 35, 36	ASCII 2 digits Error code: 01H, 02H, 03H, 09H, 11H, 12H
50095	60 61	R W	CH50 calculation formula 37, 38	ASCII 2 digits Error code: 01H, 02H, 03H, 09H, 11H, 12H

Reference number	Applied function code	R/W	Content	Detail
50096	60 61	R W	CH50 calculation formula 39, 40	ASCII 2 digits Error code: 01H, 02H, 03H, 09H, 11H, 12H
50097	60 61	R W	CH50 calculation formula 41, 42	ASCII 2 digits Error code: 01H, 02H, 03H, 09H, 11H, 12H
50098	60 61	R W	CH50 calculation formula 43, 44	ASCII 2 digits Error code: 01H, 02H, 03H, 09H, 11H, 12H
50099	60 61	R W	CH50 calculation formula 45, 46	ASCII 2 digits Error code: 01H, 02H, 03H, 09H, 11H, 12H
50100	60 61	R W	CH50 calculation formula 47, 48	ASCII 2 digits Error code: 01H, 02H, 03H, 09H, 11H, 12H
50102 to 50200	60 61	R W	CH51 setting parameter	Same as CH50 parameter (50002 to 50100)
50202 to 50300	60 61	R W	CH52 setting parameter	Same as CH50 parameter (50002 to 50100)
50302 to 50400	60 61	R W	CH53 setting parameter	Same as CH50 parameter (50002 to 50100)
50402 to 50500	60 61	R W	CH54 setting parameter	Same as CH50 parameter (50002 to 50100)
50502 to 50600	60 61	R W	CH55 setting parameter	Same as CH50 parameter (50002 to 50100)
50602 to 50700	60 61	R W	CH56 setting parameter	Same as CH50 parameter (50002 to 50100)
50702 to 50800	60 61	R W	CH57 setting parameter	Same as CH50 parameter (50002 to 50100)
50802 to 50900	60 61	R W	CH58 setting parameter	Same as CH50 parameter (50002 to 50100)
50902 to 51000	60 61	R W	CH59 setting parameter	Same as CH50 parameter (50002 to 50100)
51002 to 51100	60 61	R W	CH60 setting parameter	Same as CH50 parameter (50002 to 50100)
51102 to 51200	60 61	R W	CH61 setting parameter	Same as CH50 parameter (50002 to 50100)
51202 to 51300	60 61	R W	CH62 setting parameter	Same as CH50 parameter (50002 to 50100)
51302 to 51400	60 61	R W	CH63 setting parameter	Same as CH50 parameter (50002 to 50100)
51402 to 51500	60 61	R W	CH64 setting parameter	Same as CH50 parameter (50002 to 50100)

Reference number	Applied function code	R/W	Content	Detail
51502 to 51600	60 61	R W	CH65 setting parameter	Same as CH50 parameter (50002 to 50100)
51602 to 51700	60 61	R W	CH66 setting parameter	Same as CH50 parameter (50002 to 50100)
51702 to 51800	60 61	R W	CH67 setting parameter	Same as CH50 parameter (50002 to 50100)
51802 to 51900	60 61	R W	CH68 setting parameter	Same as CH50 parameter (50002 to 50100)
51902 to 52000	60 61	R W	CH69 setting parameter	Same as CH50 parameter (50002 to 50100)
52002 to 52100	60 61	R W	CH70 setting parameter	Same as CH50 parameter (50002 to 50100)
52102 to 52200	60 61	R W	CH71 setting parameter	Same as CH50 parameter (50002 to 50100)
52202 to 52300	60 61	R W	CH72 setting parameter	Same as CH50 parameter (50002 to 50100)
52302 to 52400	60 61	R W	CH73 setting parameter	Same as CH50 parameter (50002 to 50100)
52402 to 52500	60 61	R W	CH74 setting parameter	Same as CH50 parameter (50002 to 50100)
52502 to 52600	60 61	R W	CH75 setting parameter	Same as CH50 parameter (50002 to 50100)
52602 to 52700	60 61	R W	CH76 setting parameter	Same as CH50 parameter (50002 to 50100)
52702 to 52800	60 61	R W	CH77 setting parameter	Same as CH50 parameter (50002 to 50100)
52802 to 52900	60 61	R W	CH78 setting parameter	Same as CH50 parameter (50002 to 50100)
52902 to 53000	60 61	R W	CH79 setting parameter	Same as CH50 parameter (50002 to 50100)
53002 to 53100	60 61	R W	CH80 setting parameter	Same as CH50 parameter (50002 to 50100)
53102 to 53200	60 61	R W	CH81 setting parameter	Same as CH50 parameter (50002 to 50100)
53202 to 53300	60 61	R W	CH82 setting parameter	Same as CH50 parameter (50002 to 50100)
53302 to 53400	60 61	R W	CH83 setting parameter	Same as CH50 parameter (50002 to 50100)
53402 to 53500	60 61	R W	CH84 setting parameter	Same as CH50 parameter (50002 to 50100)
53502 to 53600	60 61	R W	CH85 setting parameter	Same as CH50 parameter (50002 to 50100)

Reference number	Applied function code	R/W	Content	Detail
53602 to 53700	60 61	R W	CH86 setting parameter	Same as CH50 parameter (50002 to 50100)
53702 to 53800	60 61	R W	CH87 setting parameter	Same as CH50 parameter (50002 to 50100)
53802 to 53900	60 61	R W	CH88 setting parameter	Same as CH50 parameter (50002 to 50100)
53902 to 54000	60 61	R W	CH89 setting parameter	Same as CH50 parameter (50002 to 50100)
54002 to 54100	60 61	R W	CH90 setting parameter	Same as CH50 parameter (50002 to 50100)
54102 to 54200	60 61	R W	CH91 setting parameter	Same as CH50 parameter (50002 to 50100)
54202 to 54300	60 61	R W	CH92 setting parameter	Same as CH50 parameter (50002 to 50100)
54302 to 54400	60 61	R W	CH93 setting parameter	Same as CH50 parameter (50002 to 50100)
54402 to 54500	60 61	R W	CH94 setting parameter	Same as CH50 parameter (50002 to 50100)
54502 to 54600	60 61	R W	CH95 setting parameter	Same as CH50 parameter (50002 to 50100)
54602 to 54700	60 61	R W	CH96 setting parameter	Same as CH50 parameter (50002 to 50100)
54702 to 54800	60 61	R W	CH97 setting parameter	Same as CH50 parameter (50002 to 50100)
54802 to 54900	60 61	R W	CH98 setting parameter	Same as CH50 parameter (50002 to 50100)
54902 to 55000	60 61	R W	CH99 setting parameter	Same as CH50 parameter (50002 to 50100)
55002 to 55100	60 61	R W	CH100 setting parameter	Same as CH50 parameter (50002 to 50100)
55102 to 55200	60 61	R W	CH101 setting parameter	Same as CH50 parameter (50002 to 50100)
55202 to 55300	60 61	R W	CH102 setting parameter	Same as CH50 parameter (50002 to 50100)
55302 to 55400	60 61	R W	CH103 setting parameter	Same as CH50 parameter (50002 to 50100)
55402 to 55500	60 61	R W	CH104 setting parameter	Same as CH50 parameter (50002 to 50100)
55502 to 55600	60 61	R W	CH105 setting parameter	Same as CH50 parameter (50002 to 50100)
55602 to 55700	60 61	R W	CH106 setting parameter	Same as CH50 parameter (50002 to 50100)
55702 to 55800	60 61	R W	CH107 setting parameter	Same as CH50 parameter (50002 to 50100)

Reference number	Applied function code	R/W	Content	Detail
55802 to 55900	60 61	R W	CH108 setting parameter	Same as CH50 parameter (50002 to 50100)
55902 to 56000	60 61	R W	CH109 setting parameter	Same as CH50 parameter (50002 to 50100)
56002 to 56100	60 61	R W	CH110 setting parameter	Same as CH50 parameter (50002 to 50100)
56102 to 56200	60 61	R W	CH111 setting parameter	Same as CH50 parameter (50002 to 50100)
56202 to 56300	60 61	R W	CH112 setting parameter	Same as CH50 parameter (50002 to 50100)
56302 to 56400	60 61	R W	CH113 setting parameter	Same as CH50 parameter (50002 to 50100)
56402 to 56500	60 61	R W	CH114setting parameter	Same as CH50 parameter (50002 to 50100)
56502 to 56600	60 61	R W	CH115 setting parameter	Same as CH50 parameter (50002 to 50100)
56602 to 56700	60 61	R W	CH116 setting parameter	Same as CH50 parameter (50002 to 50100)
56702 to 56800	60 61	R W	CH117 setting parameter	Same as CH50 parameter (50002 to 50100)
56802 to 56900	60 61	R W	CH118 setting parameter	Same as CH50 parameter (50002 to 50100)
56902 to 57000	60 61	R W	CH119 setting parameter	Same as CH50 parameter (50002 to 50100)
57002 to 57100	60 61	R W	CH120 setting parameter	Same as CH50 parameter (50002 to 50100)
57102 to 57200	60 61	R W	CH121 setting parameter	Same as CH50 parameter (50002 to 50100)
57202 to 57300	60 61	R W	CH122 setting parameter	Same as CH50 parameter (50002 to 50100)
57302 to 57400	60 61	R W	CH123 setting parameter	Same as CH50 parameter (50002 to 50100)
57402 to 57500	60 61	R W	CH124setting parameter	Same as CH50 parameter (50002 to 50100)
57502 to 57600	60 61	R W	CH125 setting parameter	Same as CH50 parameter (50002 to 50100)
57602 to 57700	60 61	R W	CH126 setting parameter	Same as CH50 parameter (50002 to 50100)
57702 to 57800	60 61	R W	CH127 setting parameter	Same as CH50 parameter (50002 to 50100)
57802 to 57900	60 61	R W	CH128 setting parameter	Same as CH50 parameter (50002 to 50100)

8-5-2 Communications parameter(from CH45)

Reference number	Applied function code	R/W	Content	Detail
58001	60 61	R W	E-mail attached data CH45	Bit correspondence Bit 0: Address 1 to Bit 7: Address 8 0: Not attached, 1: Attached Error code: 01H, 02H, 03H, 09H, 11H, 12H
58002	60 61	R W	E-mail attached data CH46	Bit correspondence Bit 0: Address 1 to Bit 7: Address 8 0: Not attached, 1: Attached Error code: 01H, 02H, 03H, 09H, 11H, 12H
58003	60 61	R W	E-mail attached data CH47	Bit correspondence Bit 0: Address 1 to Bit 7: Address 8 0: Not attached, 1: Attached Error code: 01H, 02H, 03H, 09H, 11H, 12H
58004	60 61	R W	E-mail attached data CH48	Bit correspondence Bit 0: Address 1 to Bit 7: Address 8 0: Not attached, 1: Attached Error code: 01H, 02H, 03H, 09H, 11H, 12H
58005	60 61	R W	E-mail attached data CH49	Bit correspondence Bit 0: Address 1 to Bit 7: Address 8 0: Not attached, 1: Attached Error code: 01H, 02H, 03H, 09H, 11H, 12H
58006	60 61	R W	E-mail attached data CH50	Bit correspondence Bit 0: Address 1 to Bit 7: Address 8 0: Not attached, 1: Attached Error code: 01H, 02H, 03H, 09H, 11H, 12H
58007	60 61	R W	E-mail attached data CH21	Bit correspondence Bit 0: Address 1 to Bit 7: Address 8 0: Not attached, 1: Attached Error code: 01H, 02H, 03H, 09H, 11H, 12H
58008	60 61	R W	E-mail attached data CH52	Bit correspondence Bit 0: Address 1 to Bit 7: Address 8 0: Not attached, 1: Attached Error code: 01H, 02H, 03H, 09H, 11H, 12H
58009	60 61	R W	E-mail attached data CH53	Bit correspondence Bit 0: Address 1 to Bit 7: Address 8 0: Not attached, 1: Attached Error code: 01H, 02H, 03H, 09H, 11H, 12H
58010	60 61	R W	E-mail attached data CH54	Bit correspondence Bit 0: Address 1 to Bit 7: Address 8 0: Not attached, 1: Attached Error code: 01H, 02H, 03H, 09H, 11H, 12H
58011	60 61	R W	E-mail attached data CH55	Bit correspondence Bit 0: Address 1 to Bit 7: Address 8 0: Not attached, 1: Attached Error code: 01H, 02H, 03H, 09H, 11H, 12H

Reference number	Applied function code	R/W	Content	Detail
58012	60 61	R W	E-mail attached data CH56	Bit correspondence Bit 0: Address 1 to Bit 7: Address 8 0: Not attached, 1: Attached Error code: 01H, 02H, 03H, 09H, 11H, 12H
58013	60 61	R W	E-mail attached data CH57	Bit correspondence Bit 0: Address 1 to Bit 7: Address 8 0: Not attached, 1: Attached Error code: 01H, 02H, 03H, 09H, 11H, 12H
58014	60 61	R W	E-mail attached data CH58	Bit correspondence Bit 0: Address 1 to Bit 7: Address 8 0: Not attached, 1: Attached Error code: 01H, 02H, 03H, 09H, 11H, 12H
58015	60 61	R W	E-mail attached data CH59	Bit correspondence Bit 0: Address 1 to Bit 7: Address 8 0: Not attached, 1: Attached Error code: 01H, 02H, 03H, 09H, 11H, 12H
58016	60 61	R W	E-mail attached data CH60	Bit correspondence Bit 0: Address 1 to Bit 7: Address 8 0: Not attached, 1: Attached Error code: 01H, 02H, 03H, 09H, 11H, 12H
58017	60 61	R W	E-mail attached data CH61	Bit correspondence Bit 0: Address 1 to Bit 7: Address 8 0: Not attached, 1: Attached Error code: 01H, 02H, 03H, 09H, 11H, 12H
58018	60 61	R W	E-mail attached data CH62	Bit correspondence Bit 0: Address 1 to Bit 7: Address 8 0: Not attached, 1: Attached Error code: 01H, 02H, 03H, 09H, 11H, 12H
58019	60 61	R W	E-mail attached data CH63	Bit correspondence Bit 0: Address 1 to Bit 7: Address 8 0: Not attached, 1: Attached Error code: 01H, 02H, 03H, 09H, 11H, 12H
58020	60 61	R W	E-mail attached data CH64	Bit correspondence Bit 0: Address 1 to Bit 7: Address 8 0: Not attached, 1: Attached Error code: 01H, 02H, 03H, 09H, 11H, 12H
58021	60 61	R W	E-mail attached data CH65	Bit correspondence Bit 0: Address 1 to Bit 7: Address 8 0: Not attached, 1: Attached Error code: 01H, 02H, 03H, 09H, 11H, 12H
58022	60 61	R W	E-mail attached data CH66	Bit correspondence Bit 0: Address 1 to Bit 7: Address 8 0: Not attached, 1: Attached Error code: 01H, 02H, 03H, 09H, 11H, 12H
58023	60 61	R W	E-mail attached data CH67	Bit correspondence Bit 0: Address 1 to Bit 7: Address 8 0: Not attached, 1: Attached Error code: 01H, 02H, 03H, 09H, 11H, 12H

Reference number	Applied function code	R/W	Content	Detail
58024	60 61	R W	E-mail attached data CH68	Bit correspondence Bit 0: Address 1 to Bit 7: Address 8 0: Not attached, 1: Attached Error code: 01H, 02H, 03H, 09H, 11H, 12H
58025	60 61	R W	E-mail attached data CH69	Bit correspondence Bit 0: Address 1 to Bit 7: Address 8 0: Not attached, 1: Attached Error code: 01H, 02H, 03H, 09H, 11H, 12H
58026	60 61	R W	E-mail attached data CH70	Bit correspondence Bit 0: Address 1 to Bit 7: Address 8 0: Not attached, 1: Attached Error code: 01H, 02H, 03H, 09H, 11H, 12H
58027	60 61	R W	E-mail attached data CH71	Bit correspondence Bit 0: Address 1 to Bit 7: Address 8 0: Not attached, 1: Attached Error code: 01H, 02H, 03H, 09H, 11H, 12H
58028	60 61	R W	E-mail attached data CH72	Bit correspondence Bit 0: Address 1 to Bit 7: Address 8 0: Not attached, 1: Attached Error code: 01H, 02H, 03H, 09H, 11H, 12H
58029	60 61	R W	E-mail attached data CH73	Bit correspondence Bit 0: Address 1 to Bit 7: Address 8 0: Not attached, 1: Attached Error code: 01H, 02H, 03H, 09H, 11H, 12H
58030	60 61	R W	E-mail attached data CH74	Bit correspondence Bit 0: Address 1 to Bit 7: Address 8 0: Not attached, 1: Attached Error code: 01H, 02H, 03H, 09H, 11H, 12H
58031	60 61	R W	E-mail attached data CH75	Bit correspondence Bit 0: Address 1 to Bit 7: Address 8 0: Not attached, 1: Attached Error code: 01H, 02H, 03H, 09H, 11H, 12H
58032	60 61	R W	E-mail attached data CH76	Bit correspondence Bit 0: Address 1 to Bit 7: Address 8 0: Not attached, 1: Attached Error code: 01H, 02H, 03H, 09H, 11H, 12H
58033	60 61	R W	E-mail attached data CH77	Bit correspondence Bit 0: Address 1 to Bit 7: Address 8 0: Not attached, 1: Attached Error code: 01H, 02H, 03H, 09H, 11H, 12H
58034	60 61	R W	E-mail attached data CH78	Bit correspondence Bit 0: Address 1 to Bit 7: Address 8 0: Not attached, 1: Attached Error code: 01H, 02H, 03H, 09H, 11H, 12H
58035	60 61	R W	E-mail attached data CH79	Bit correspondence Bit 0: Address 1 to Bit 7: Address 8 0: Not attached, 1: Attached Error code: 01H, 02H, 03H, 09H, 11H, 12H

Reference number	Applied function code	R/W	Content	Detail
58036	60 61	R W	E-mail attached data CH80	Bit correspondence Bit 0: Address 1 to Bit 7: Address 8 0: Not attached, 1: Attached Error code: 01H, 02H, 03H, 09H, 11H, 12H
58037	60 61	R W	E-mail attached data CH81	Bit correspondence Bit 0: Address 1 to Bit 7: Address 8 0: Not attached, 1: Attached Error code: 01H, 02H, 03H, 09H, 11H, 12H
58038	60 61	R W	E-mail attached data CH82	Bit correspondence Bit 0: Address 1 to Bit 7: Address 8 0: Not attached, 1: Attached Error code: 01H, 02H, 03H, 09H, 11H, 12H
58039	60 61	R W	E-mail attached data CH83	Bit correspondence Bit 0: Address 1 to Bit 7: Address 8 0: Not attached, 1: Attached Error code: 01H, 02H, 03H, 09H, 11H, 12H
58040	60 61	R W	E-mail attached data CH84	Bit correspondence Bit 0: Address 1 to Bit 7: Address 8 0: Not attached, 1: Attached Error code: 01H, 02H, 03H, 09H, 11H, 12H
58041	60 61	R W	E-mail attached data CH85	Bit correspondence Bit 0: Address 1 to Bit 7: Address 8 0: Not attached, 1: Attached Error code: 01H, 02H, 03H, 09H, 11H, 12H
58042	60 61	R W	E-mail attached data CH86	Bit correspondence Bit 0: Address 1 to Bit 7: Address 8 0: Not attached, 1: Attached Error code: 01H, 02H, 03H, 09H, 11H, 12H
58043	60 61	R W	E-mail attached data CH87	Bit correspondence Bit 0: Address 1 to Bit 7: Address 8 0: Not attached, 1: Attached Error code: 01H, 02H, 03H, 09H, 11H, 12H
58044	60 61	R W	E-mail attached data CH88	Bit correspondence Bit 0: Address 1 to Bit 7: Address 8 0: Not attached, 1: Attached Error code: 01H, 02H, 03H, 09H, 11H, 12H
58045	60 61	R W	E-mail attached data CH89	Bit correspondence Bit 0: Address 1 to Bit 7: Address 8 0: Not attached, 1: Attached Error code: 01H, 02H, 03H, 09H, 11H, 12H
58046	60 61	R W	E-mail attached data CH90	Bit correspondence Bit 0: Address 1 to Bit 7: Address 8 0: Not attached, 1: Attached Error code: 01H, 02H, 03H, 09H, 11H, 12H
58047	60 61	R W	E-mail attached data CH91	Bit correspondence Bit 0: Address 1 to Bit 7: Address 8 0: Not attached, 1: Attached Error code: 01H, 02H, 03H, 09H, 11H, 12H

Reference number	Applied function code	R/W	Content	Detail
58048	60 61	R W	E-mail attached data CH92	Bit correspondence Bit 0: Address 1 to Bit 7: Address 8 0: Not attached, 1: Attached Error code: 01H, 02H, 03H, 09H, 11H, 12H
58049	60 61	R W	E-mail attached data CH93	Bit correspondence Bit 0: Address 1 to Bit 7: Address 8 0: Not attached, 1: Attached Error code: 01H, 02H, 03H, 09H, 11H, 12H
58050	60 61	R W	E-mail attached data CH94	Bit correspondence Bit 0: Address 1 to Bit 7: Address 8 0: Not attached, 1: Attached Error code: 01H, 02H, 03H, 09H, 11H, 12H
58051	60 61	R W	E-mail attached data CH95	Bit correspondence Bit 0: Address 1 to Bit 7: Address 8 0: Not attached, 1: Attached Error code: 01H, 02H, 03H, 09H, 11H, 12H
58052	60 61	R W	E-mail attached data CH96	Bit correspondence Bit 0: Address 1 to Bit 7: Address 8 0: Not attached, 1: Attached Error code: 01H, 02H, 03H, 09H, 11H, 12H
58053	60 61	R W	E-mail attached data CH97	Bit correspondence Bit 0: Address 1 to Bit 7: Address 8 0: Not attached, 1: Attached Error code: 01H, 02H, 03H, 09H, 11H, 12H
58054	60 61	R W	E-mail attached data CH98	Bit correspondence Bit 0: Address 1 to Bit 7: Address 8 0: Not attached, 1: Attached Error code: 01H, 02H, 03H, 09H, 11H, 12H
58055	60 61	R W	E-mail attached data CH99	Bit correspondence Bit 0: Address 1 to Bit 7: Address 8 0: Not attached, 1: Attached Error code: 01H, 02H, 03H, 09H, 11H, 12H
58056	60 61	R W	E-mail attached data CH100	Bit correspondence Bit 0: Address 1 to Bit 7: Address 8 0: Not attached, 1: Attached Error code: 01H, 02H, 03H, 09H, 11H, 12H
58057	60 61	R W	E-mail attached data CH101	Bit correspondence Bit 0: Address 1 to Bit 7: Address 8 0: Not attached, 1: Attached Error code: 01H, 02H, 03H, 09H, 11H, 12H
58058	60 61	R W	E-mail attached data CH102	Bit correspondence Bit 0: Address 1 to Bit 7: Address 8 0: Not attached, 1: Attached Error code: 01H, 02H, 03H, 09H, 11H, 12H
58059	60 61	R W	E-mail attached data CH103	Bit correspondence Bit 0: Address 1 to Bit 7: Address 8 0: Not attached, 1: Attached Error code: 01H, 02H, 03H, 09H, 11H, 12H

Reference number	Applied function code	R/W	Content	Detail
58060	60 61	R W	E-mail attached data CH104	Bit correspondence Bit 0: Address 1 to Bit 7: Address 8 0: Not attached, 1: Attached Error code: 01H, 02H, 03H, 09H, 11H, 12H
58061	60 61	R W	E-mail attached data CH105	Bit correspondence Bit 0: Address 1 to Bit 7: Address 8 0: Not attached, 1: Attached Error code: 01H, 02H, 03H, 09H, 11H, 12H
58062	60 61	R W	E-mail attached data CH106	Bit correspondence Bit 0: Address 1 to Bit 7: Address 8 0: Not attached, 1: Attached Error code: 01H, 02H, 03H, 09H, 11H, 12H
58063	60 61	R W	E-mail attached data CH107	Bit correspondence Bit 0: Address 1 to Bit 7: Address 8 0: Not attached, 1: Attached Error code: 01H, 02H, 03H, 09H, 11H, 12H
58064	60 61	R W	E-mail attached data CH108	Bit correspondence Bit 0: Address 1 to Bit 7: Address 8 0: Not attached, 1: Attached Error code: 01H, 02H, 03H, 09H, 11H, 12H
58065	60 61	R W	E-mail attached data CH109	Bit correspondence Bit 0: Address 1 to Bit 7: Address 8 0: Not attached, 1: Attached Error code: 01H, 02H, 03H, 09H, 11H, 12H
58066	60 61	R W	E-mail attached data CH110	Bit correspondence Bit 0: Address 1 to Bit 7: Address 8 0: Not attached, 1: Attached Error code: 01H, 02H, 03H, 09H, 11H, 12H
58067	60 61	R W	E-mail attached data CH111	Bit correspondence Bit 0: Address 1 to Bit 7: Address 8 0: Not attached, 1: Attached Error code: 01H, 02H, 03H, 09H, 11H, 12H
58068	60 61	R W	E-mail attached data CH112	Bit correspondence Bit 0: Address 1 to Bit 7: Address 8 0: Not attached, 1: Attached Error code: 01H, 02H, 03H, 09H, 11H, 12H
58069	60 61	R W	E-mail attached data CH113	Bit correspondence Bit 0: Address 1 to Bit 7: Address 8 0: Not attached, 1: Attached Error code: 01H, 02H, 03H, 09H, 11H, 12H
58070	60 61	R W	E-mail attached data CH114	Bit correspondence Bit 0: Address 1 to Bit 7: Address 8 0: Not attached, 1: Attached Error code: 01H, 02H, 03H, 09H, 11H, 12H
58071	60 61	R W	E-mail attached data CH115	Bit correspondence Bit 0: Address 1 to Bit 7: Address 8 0: Not attached, 1: Attached Error code: 01H, 02H, 03H, 09H, 11H, 12H

Reference number	Applied function code	R/W	Content	Detail
58072	60 61	R W	E-mail attached data CH116	Bit correspondence Bit 0: Address 1 to Bit 7: Address 8 0: Not attached, 1: Attached Error code: 01H, 02H, 03H, 09H, 11H, 12H
58073	60 61	R W	E-mail attached data CH117	Bit correspondence Bit 0: Address 1 to Bit 7: Address 8 0: Not attached, 1: Attached Error code: 01H, 02H, 03H, 09H, 11H, 12H
58074	60 61	R W	E-mail attached data CH118	Bit correspondence Bit 0: Address 1 to Bit 7: Address 8 0: Not attached, 1: Attached Error code: 01H, 02H, 03H, 09H, 11H, 12H
58075	60 61	R W	E-mail attached data CH119	Bit correspondence Bit 0: Address 1 to Bit 7: Address 8 0: Not attached, 1: Attached Error code: 01H, 02H, 03H, 09H, 11H, 12H
58076	60 61	R W	E-mail attached data CH120	Bit correspondence Bit 0: Address 1 to Bit 7: Address 8 0: Not attached, 1: Attached Error code: 01H, 02H, 03H, 09H, 11H, 12H
58077	60 61	R W	E-mail attached data CH121	Bit correspondence Bit 0: Address 1 to Bit 7: Address 8 0: Not attached, 1: Attached Error code: 01H, 02H, 03H, 09H, 11H, 12H
58078	60 61	R W	E-mail attached data CH122	Bit correspondence Bit 0: Address 1 to Bit 7: Address 8 0: Not attached, 1: Attached Error code: 01H, 02H, 03H, 09H, 11H, 12H
58079	60 61	R W	E-mail attached data CH123	Bit correspondence Bit 0: Address 1 to Bit 7: Address 8 0: Not attached, 1: Attached Error code: 01H, 02H, 03H, 09H, 11H, 12H
58080	60 61	R W	E-mail attached data CH124	Bit correspondence Bit 0: Address 1 to Bit 7: Address 8 0: Not attached, 1: Attached Error code: 01H, 02H, 03H, 09H, 11H, 12H
58081	60 61	R W	E-mail attached data CH125	Bit correspondence Bit 0: Address 1 to Bit 7: Address 8 0: Not attached, 1: Attached Error code: 01H, 02H, 03H, 09H, 11H, 12H
58082	60 61	R W	E-mail attached data CH126	Bit correspondence Bit 0: Address 1 to Bit 7: Address 8 0: Not attached, 1: Attached Error code: 01H, 02H, 03H, 09H, 11H, 12H
58083	60 61	R W	E-mail attached data CH127	Bit correspondence Bit 0: Address 1 to Bit 7: Address 8 0: Not attached, 1: Attached Error code: 01H, 02H, 03H, 09H, 11H, 12H

Reference number	Applied function code	R/W	Content	Detail
58084	60 61	R W	E-mail attached data CH128	Bit correspondence Bit 0: Address 1 to Bit 7: Address 8 0: Not attached, 1: Attached Error code: 01H, 02H, 03H, 09H, 11H, 12H

8-6 Range number table

Input type		Range number	Measurement range			Decimal place	
DC voltage		01	-13.80	—	13.80	mV	2
		02	-27.60	—	27.60	mV	2
		03	-69.00	—	69.00	mV	2
		04	-200.0	—	200.0	mV	1
		05	-500.0	—	500.0	mV	1
		06	-2.000	—	2.000	V	3
		07	-5.000	—	5.000	V	3
		08	-10.00	—	10.00	V	2
		09	-20.00	—	20.00	V	2
		10	-50.00	—	50.00	V	2
Thermocouple	K	21	-200.0	—	300.0	°C	1
		22	-200.0	—	600.0	°C	1
		23	-200	—	1370	°C	0
	E	24	-200.0	—	200.0	°C	1
		25	-200.0	—	350.0	°C	1
		26	-200	—	900	°C	0
	J	27	-200.0	—	250.0	°C	1
		28	-200.0	—	500.0	°C	1
		29	-200	—	1200	°C	0
	T	30	-200.0	—	250.0	°C	1
		31	-200.0	—	400.0	°C	1
	R	32	0	—	1200	°C	0
		33	0	—	1760	°C	0
	S	34	0	—	1300	°C	0
		35	0	—	1760	°C	0
	B	36	0	—	1820	°C	0
	N	37	-200.0	—	400.0	°C	1
		38	-200.0	—	750.0	°C	1
		39	-200	—	1300	°C	0
	W-WRe26	40	0	—	2315	°C	0
	WRe5-WRe26	41	0	—	2315	°C	0
	PR40-20	43	0	—	1888	°C	0
	NiMo-Ni	44	-50.0	—	290.0	°C	1
		45	-50.0	—	600.0	°C	1
		46	-50	—	1310	°C	0
	CR-AuFe	47	0.0	—	280.0	K	1
Platinel 2	48	0.0	—	350.0	°C	1	
	49	0.0	—	650.0	°C	1	
	50	0	—	1395	°C	0	
U	51	-200.0	—	250.0	°C	1	
	52	-200.0	—	500.0	°C	1	
	53	-200.0	—	600.0	°C	1	
L	54	-200.0	—	250.0	°C	1	
	55	-200.0	—	500.0	°C	1	
	56	-200	—	900	°C	0	

Input type		Range number	Measurement range				Decimal place
RTD	Pt100	70	-140.0	—	150.0	°C	1
		71	-200.0	—	300.0	°C	1
		72	-200.0	—	850.0	°C	1
	JPt100	76	-140.0	—	150.0	°C	1
		77	-200.0	—	300.0	°C	1
		78	-200.0	—	649.0	°C	1
	Pt50	79	-200.0	—	649.0	°C	1
	Pt-Co	80	4.0	—	374.0	K	1
DI	90	0 (OFF) / 1 (ON)				0	
Pulse(+)	91	0	—	30000	0		
Pulse(-)	92	0	—	30000	0		

9 Setting/displaying on Web screen (Option)

9-1 Display and settings using the Web screen

By using the web browser, the settings relating to inputs and records of this recorder can be configured and the data can be displayed.

9-1-1 Top page

By accessing to the IP address of this recorder via the web browser (The figure shows Internet Explorer.), the following screen is displayed after the password authentication.

The default user name used for the password authentication is “user”. However, user name and the password can be changed to arbitrary characters at this recorder side. When the Link button is clicked, the screen moves to the “Recorder display” for displaying the same screen, on which the same operation can be executed, as this recorder on the browser, the “Data display” for displaying the data of each recording channel, the “Input settings” for setting input parameters of every channel, the “Alarm settings” for setting alarm parameters, the “Calculation settings” for setting formulas of every channel, the “Group settings” for setting record-related-items and the “Marker text setting” for setting marker texts.



9-1-2 Recorder display

The same contents as this recorder are displayed. The keys arranged at the lower part of the screen can be operated like the keys of this recorder. If click the screen by mouse, it is possible to operate as same as touch panel operation like the main instrument. Because of the image file used, it takes more time for loading than other screens. For preventing operational error, do not operate this recorder and this screen together at the same time.

Do not use the “Refresh”, “Back”, “Forward”, etc. on the browser and use the keys at the lower part screen.

When the ‘Refresh’ key at the lower right of the screen is clicked, the current display is reloaded. By clicking the “Auto refresh ON”, the screen is updated at about 1 minute interval. For stopping the auto refresh, click the “Auto refresh OFF”.

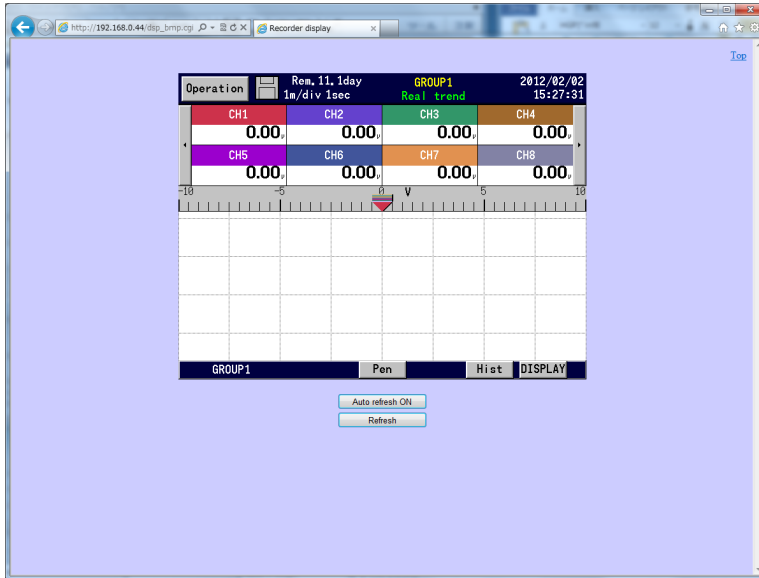

9-1-3 Data display

The data of channels of this recorder are displayed with tag names and engineering units. Two kinds of screens are selectable, the screen fixedly displaying data obtained at the time of displaying it and the screen displaying data automatically updated every 10 seconds. When the link is clicked on the top page, the screen moves to the screen fixedly displaying data obtained at the time of displaying it. For moving to the automatic updating screen, click the “Start auto refresh” link at the lower part of the screen. Also, for moving to the fixed display during the automatic updating display, click the “Stop auto refresh” link at the lower part of the screen.

Channel number	Tag	Data	Unit	Channel number	Tag	Data	Unit
01		0.00	V	23		0.00	V
02		0.00	V	24		0.00	V
03		0.00	V	25		0.00	V
04		0.00	V	26		0.00	V
05		0.00	V	27		0.00	V
06		0.00	V	28		0.00	V
07		0.00	V	29		0.00	V
08		0.00	V	30		0.00	V
09		0.00	V	31		0.00	V
10		0.00	V	32		0.00	V
11		0.00	V	33		0.00	V
12		0.00	V	34		0.00	V
13		0.00	V	35		0.00	V
14		0.00	V	36		0.00	V
15		0.00	V	37		0.00	V
16		0.00	V	38		0.00	V
17		0.00	V	39		0.00	V
18		0.00	V	40		0.00	V
19		0.00	V	41		0	
20		0.00	V	42		1	
21		0.00	V	43		1	
22		0.00	V	44		1	

9-1-4 Input settings

This is for changing the settings of the input parameters of this recorder. By clicking the “Set” button after entering each item, the setting contents are written in this recorder. The displaying channel block can be switched by selecting the link from the "Channel number" table at the upper part of the screen. The settings cannot be changed during recording.

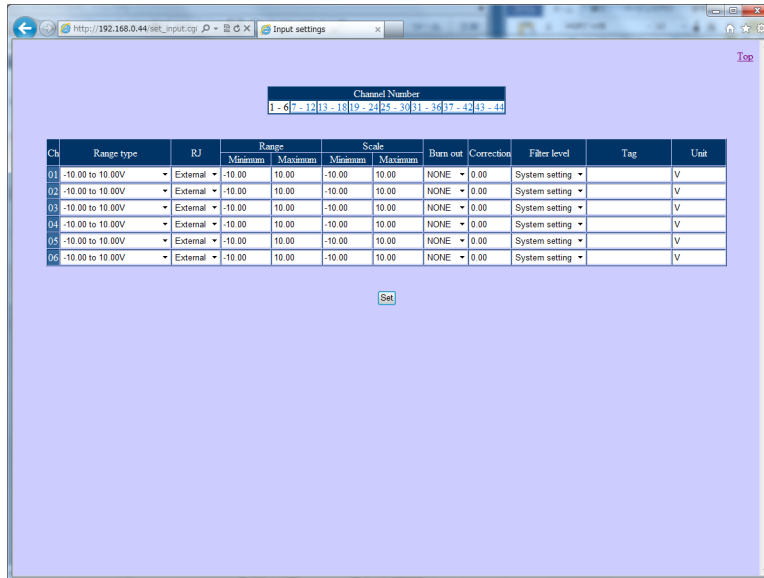

Setting items	Contents
Range type	Select the input range.
RJ	Select the reference junction compensation from internal or external.
Range Minimum	Set the minimum value of the range.
Range Maximum	Set the maximum value of the range.
Scale Minimum	Set the minimum value of the scale.
Scale Maximum	Set the maximum value of the scale.
Burn out	Select the burn out from up, down or none.
Correction	Set the value (shift value) added to the input value.
Filter level	The input filter level can be set from 0 to 3. 0 means no-filter and 3 means the strongest filter. When [system settings] is selected, settings are following [system settings] – [other settings].
Tag	Set the tag name for the data with maximum 15 characters.
Unit	Set the engineering unit for the data with maximum 7 characters.

9-1-5 Alarm settings

This is for changing the settings of the alarm parameters of this recorder. By clicking the “Set” button after entering each item, the setting contents are written in this recorder. The displaying channel block can be switched by selecting the link from the "Channel number" table at the upper part of the screen.

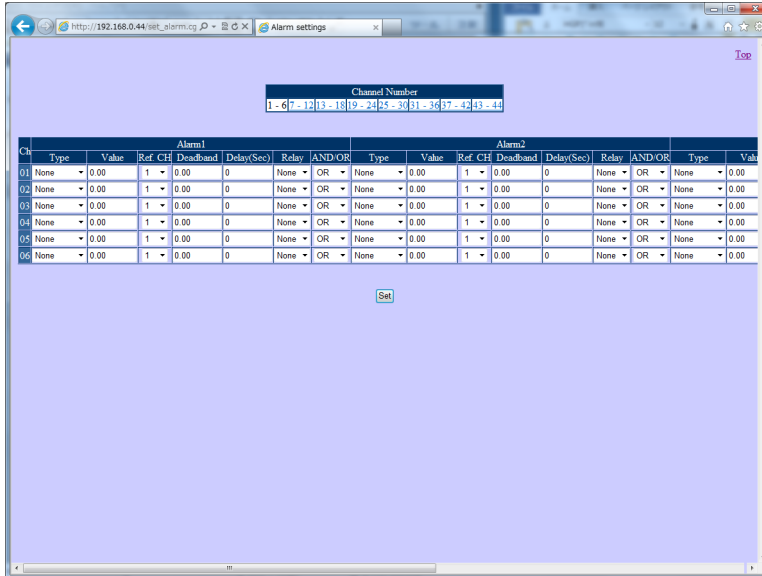

Setting items	Contents
Alarm 1 to 4 Type	Select the alarm type.
Alarm 1 to 4 Alarm value	Set the alarm value of each alarm.
Alarm 1 to 4 Reference CH	When the differential alarm is set in the alarm type of each alarm, select the reference channel.
Alarm 1 to 4 Dead band	Set the dead band of each alarm.
Alarm 1 to 4 Delay	Set the delay of each alarm from 0 to 3600 seconds.
Alarm 1 to 4 Relay	Select the output destination relay number at the activation of each alarm.
Alarm 1 to 4 AND/OR	Set the alarm output mode.

9-1-6 Calculation settings

This is for selecting whether the calculation for each channel of this recorder is used or not, and for setting the formula. When the “Set” button is clicked after entering each item, the setting contents are written in this recorder. The settings cannot be changed during recording.

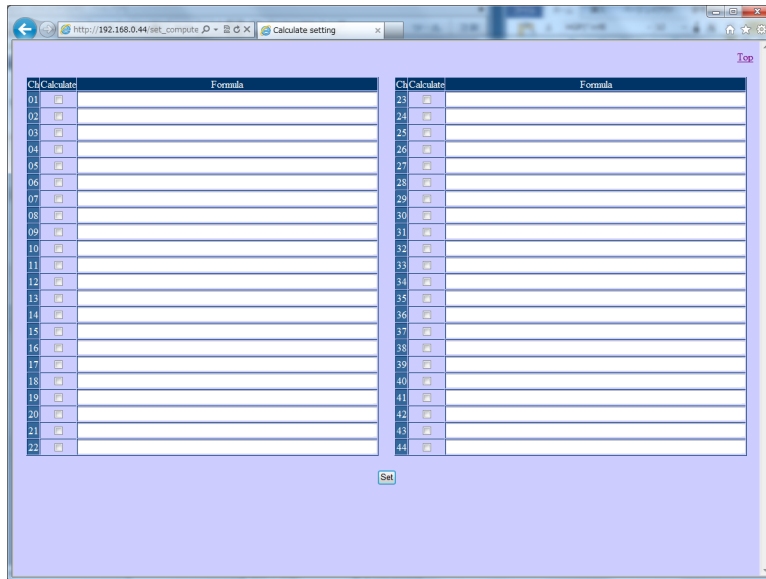

Setting items	Contents
Calculate	Select whether the calculation is used or not.
Formula	Set the formula with maximum 48 characters.

9-1-7 Group settings

This is for changing the settings of the record-related-parameters of this recorder. When the “Set” button is clicked after entering each item, the setting contents are written in this recorder. The settings of one group are displayed on one screen. The group to be displayed can be switched by selecting from the "Group number" table on the upper part of the screen. The group that can be selected here is the groups from the Group 1 to the usage group count set in “System settings” → “Other settings” of this recorder. The settings of the group with the Record ON/OFF checked cannot be changed during recording.

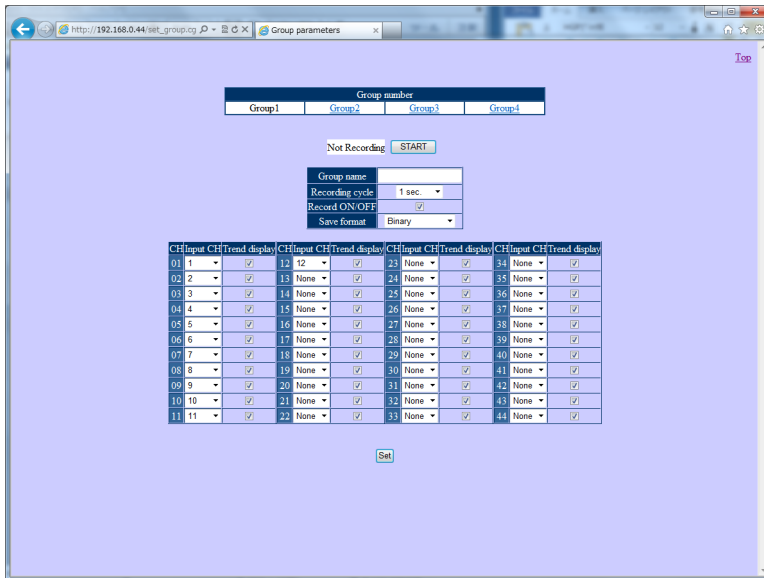

Setting items	Contents
Group name	Set the group name with maximum 16 characters.
Recording period	Select the time interval for displaying and recording the data.
Record ON/OFF	Select whether its group is recorded or not.
Save format	Select the file format for recording the data into a CF card.
Input CH	Select the input channel number to be recorded in each recording channel.
Trend display	Select whether the trends of each channel are displayed or not on the screen.

9-1-8 Marker text settings

This is for changing the settings of the maker text parameters of this recorder. When the “Set” button is clicked after entering each item, the setting contents are written in this recorder. By setting the text at the last column (No. 10 in the figure), 10 more columns are displayed. Up to 50 texts can be registered.

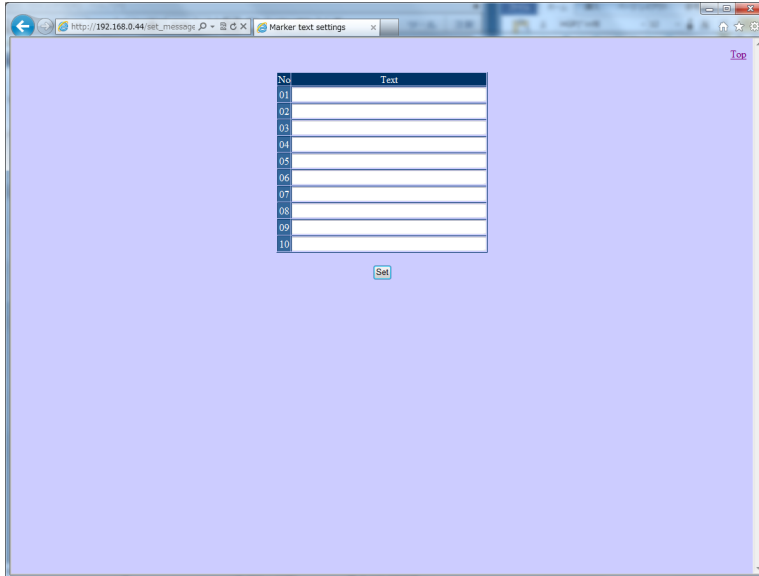

Setting items	Contents
Text (No. 01 to 50)	Set the marker text with maximum 30 characters.

CHINO

CHINO CORPORATION

32-8, KUMANO-CHO, ITABASHI-KU, TOKYO 173-8632

Telephone: 81-3-3956-2171

Facsimile: 81-3-3956-0915

E-mail: inter@chino.co.jp



Printed in Japan