

# General Specifications

GS 01C31H01-11EN

EJA118E/Z  
Diaphragm Sealed  
Differential Pressure Transmitter  
(Inner Diaphragm type)

DPharp **EJA**™

[Style: S2]

Diaphragm seals are used to prevent process medium from entering directly into the pressure-sensing assembly of the differential pressure transmitter, they are connected to the transmitter using capillaries filled with fill fluid.

Inner diaphragm type can be installed to small size frange which is 1 inch, 3/4 inch or 1/2 inch. And the performance is the same as 2 inch, because it is used the diaphragm size same as 2 inch. EJA118E Diaphragm Sealed Differential Pressure Transmitters can be used to measure liquid, gas, or steam flow, as well as liquid level, density, and pressure. EJA118E outputs a 4 to 20 mA DC signal corresponding to the measured differential pressure. Its highly accurate and stable sensor can also measure the static pressure which can be shown on the integral indicator or remotely monitored via BRAIN or HART communications. Other key features include quick response, remote set-up using communications, and diagnostics. FOUNDATION Fieldbus, PROFIBUS PA and 1 to 5 V DC with HART (Low Power) protocol types are also available.



Adapter connection type



Flange connection type

## STANDARD SPECIFICATIONS

Refer to GS 01C31T02-01EN for Fieldbus communication type and GS 01C31T04-01EN for PROFIBUS PA communication type for the items marked with "◇."

### SPAN AND RANGE LIMITS

Measurement Span/Range	kPa	inH <sub>2</sub> O/(D1)	mbar/(D3)	mmH <sub>2</sub> O/(D4)	
M	Span	2.5 to 100	10 to 400	25 to 1000	250 to 10000
	Range	-100 to 100	-400 to 400	-1000 to 1000	-10000 to 10000
H	Span	25 to 500	100 to 2000	250 to 5000	0.25 to 5 kgf/cm <sup>2</sup>
	Range	-500 to 500	-2000 to 2000	-5000 to 5000	-5 to 5 kgf/cm <sup>2</sup>

### PERFORMANCE SPECIFICATIONS

Zero-based calibrated span, linear output, wetted parts material code S□, fill fluid code B, and capillary length of 5 m. For Fieldbus and PROFIBUS communication types, use caribrated range instead of span in the following specifications.

#### Specification Conformance

EJA-E series ensures specification conformance to at least ±3σ.

#### Reference Accuracy of Calibrated Span

(includes terminal-based linearity, hysteresis, and repeatability)

Measurement span	M
Reference accuracy	X ≤ span: ±0.2% of Span X > span: ±(0.15+0.01 URL/span)% of Span
X	20 kPa (80 inH <sub>2</sub> O)
URL (upper range limit)	100 kPa (400 inH <sub>2</sub> O)

Measurement span	H
Reference accuracy	X ≤ span: ±0.2% of Span X > span: ±(0.15+0.01 URL/span)% of Span
X	100 kPa (400 inH <sub>2</sub> O)
URL (upper range limit)	500 kPa (2000 inH <sub>2</sub> O)

#### Square Root Output Accuracy

The square root accuracy is a percent of flow span.

Output	Accuracy
50% or Greater	Same as reference accuracy
50% to Dropout point	Reference accuracy × 50 Square root output (%)

#### Ambient Temperature Effects per 50°C (122°F) Change

Capsule	M and H
Zero shift	±(0.2+0.7 × $\frac{X}{A}$ )%
Total shift	±1.4% A ≥ X
	±(1.4 × $\frac{X}{A}$ )% A < X

'A' is the highest value among the absolute values of lower range value (LRV) and upper range value (URV), and the span value in calibration range.

**Static Pressure Effects per 0.69 MPa (100 psi) Change****Span Effects**M and H capsules

±0.02% of span

**Effect on Zero**M and H capsules

±0.014% of URL

**Power Supply Effects (Output signal code D and J)**

±0.005% per Volt (from 21.6 to 32 V DC, 350 Ω)

**Response Time (Differential pressure) “◇”**

M and H capsule: 200 ms (approximate value at normal temperature)

When software damping is set to zero and including dead time of 45 ms (nominal)

**Static Pressure Signal Range and Accuracy****(For monitoring via communication or on indicator. Includes terminal-based linearity, hysteresis, and repeatability)****Range**

Upper Range Value and Lower Range Value of the static pressure can be set in the range between 0 and Maximum Working Pressure (MWP\*). The upper range value must be greater than the lower range value. Minimum setting span is 0.5 MPa (73 psi).

\*: Maximum Working Pressure (MWP) is within flange rating pressure.

**Accuracy**Absolute Pressure

1 MPa or higher : ±0.5% of span

Less than 1 MPa: ±0.5% × (1 MPa/span) of span

Gauge Pressure Reference

Gauge pressure reference is 1013 hPa (1 atm)

Note : Gauge pressure variable is based on the above fixed reference and thus subject to be affected by the change of atmospheric pressure.

**□ FUNCTIONAL SPECIFICATIONS****Output “◇”****For 4 to 20 mA HART / BRAIN****(Output signal code D and J)**

Two wire 4 to 20 mA DC output with digital communications, linear or square root programmable. BRAIN or HART FSK protocol are superimposed on the 4 to 20 mA signal.

Output range: 3.6 mA to 21.6 mA

Output limits conform to NAMUR NE43 can be pre-set by option code C2 or C3.

**For 1 to 5 V HART (Output signal code Q)**

Three or four wire low power 1 to 5 V DC output with HART, linear or square root programmable. HART protocol are superimposed on the 1 to 5 V DC signal.

Output range: 0.9 V to 5.4 V DC

**Damping Time Constant (1st order)**

Amplifier damping time constant is adjustable from 0.00 to 100.00 s by software and added to response time.

Note: For BRAIN protocol type, when amplifier software damping is set to less than 0.5 s, communication may occasionally be unavailable during the operation, especially while output changes dynamically. The default setting of damping ensures stable communication.

**Update Period “◇”**

Differential pressure: 45 ms

Static pressure: 360 ms

**Zero Adjustment Limits**

Zero can be fully elevated or suppressed, within the lower and upper range limits of the capsule.

**External Zero Adjustment**

External zero is continuously adjustable with 0.01% incremental resolution of span. Re-range can be done locally using the digital indicator with range-setting switch.

**Integral Indicator (LCD display, optional) “◇”**

5-digit numerical display, 6-digit unit display and bar graph.

The indicator is configurable to display one or up to four of the following variables periodically; Measured differential pressure, differential pressure in %, scaled differential pressure, measured static pressure. See also “Factory Setting.”

**Local Parameter Setting (Output signal code D and J)**

Parameter configuration by the external zero adjustment screw and push button (Integral indicator code E) offers easy and quick setup for parameters of Loop test, Tag number, Unit, LRV, URV, Damping, Output mode (linear/square root), Display out 1, and Re-range by applying actual pressure (LRV/URV) and Device Information.

**Self Diagnostics**

CPU failure, hardware failure, configuration error, process alarm for differential pressure, static pressure or capsule temperature.

User-configurable process high/low alarm for differential pressure and static pressure is also available.

**Signal Characterizer (Output signal code D, J and Q)**

User-configurable 10-segment signal characterizer for 4 to 20 mA output.

**Capillary Fill Fluid Density Compensation (Output signal code D, J and Q)**

Compensation of the zero shift by the ambient temperature effect on the capillary tube.

**SIL Certification**

EJA-E series transmitters except Fieldbus, PROFIBUS PA and 1-5V DC with HART (Low Power) communication types are certified in compliance with the following standards;

IEC 61508: 2010;

Functional Safety of Electrical/electronic/programmable electronic related systems; SIL 2 capability for single transmitter use, SIL 3 capability for dual transmitter use.

Reliability Data different depending on hardware and software revision.

For details, refer to Functional Safety Data Sheet.

(Document number: TI 01C25A05-01EN or TI 01C25A05-21EN for option code SLT )

The document can be downloaded from the website of Yokogawa.

(Website address: <https://www.yokogawa.com/solutions/products-platforms/field-instruments/>)

□ **NORMAL OPERATING CONDITION**

(Optional features or approval codes may affect limits.)

**Ambient Temperature Limits**

- 40 to 60°C (-40 to 140°F)
- 30 to 60°C (-22 to 140°F) with LCD display
- (Note : The ambient temperature limits must be within the fill fluid operating temperature range, see table 1.)

**Process Temperature Limits**

See table 1.

**Ambient Humidity Limits**

0 to 100% RH

**Working Pressure Limits**

See table 1.

For atmospheric pressure or below, see figure 1-1, 1-2, 1-3, and 1-4.

**Table 1. Process temperature, Ambient temperature, and Working pressure**

	Code	Process temperature* <sup>1</sup>	Ambient temperature* <sup>2</sup>	Working pressure	Specific gravity* <sup>3</sup>
Silicone oil (general use)	A	-10 to 250°C (14 to 482°F)	-10 to 60°C (14 to 140°F)	2.7 kPa abs (0.38 psi abs) to flange rating pressure	1.07
Silicone oil (general use)	B	-30 to 180°C (-22 to 356°F)	-15 to 60°C (5 to 140°F)		0.94
Fluorinated oil (oil-prohibited use)	D	-20 to 120°C (-4 to 248°F)	-10 to 60°C (14 to 140°F)	51 kPa abs (7.4 psi abs) to flange rating pressure	1.90 to 1.92
Ethylene glycol (low temperature use)	E	-50 to 100°C (-58 to 212°F)	-40 to 60°C (-40 to 140°F)	100 kPa abs (atmospheric pressure) to flange pressure rating	1.09
Silicone oil (high temp. and high vacuum use)	1	-10 to 250°C (14 to 482°F)	-10 to 50°C (14 to 122°F)	0.013 kPa abs (0.0019 psi abs) to flange rating pressure	1.07
Silicone oil (high vacuum use)	4	-10 to 100°C (14 to 212°F)	-10 to 50°C (14 to 122°F)		1.07

\*1: See figure 1-1, 1-2, 1-3, and 1-4 'Working Pressure and Process Temperature.'

\*2: This ambient temperature is the transmitter ambient temperature.

\*3: Approximate values at a temperature of 25°C (77°F)

Note: The differential pressure transmitter should be installed at least 600 mm below the high pressure (HP) process connection. However, this value (600 mm) may be affected by ambient temperature, operating pressure, fill fluid or material of the wetted diaphragm.

Contact YOKOGAWA when the transmitter can not be installed at least 600 mm below the HP process connection.

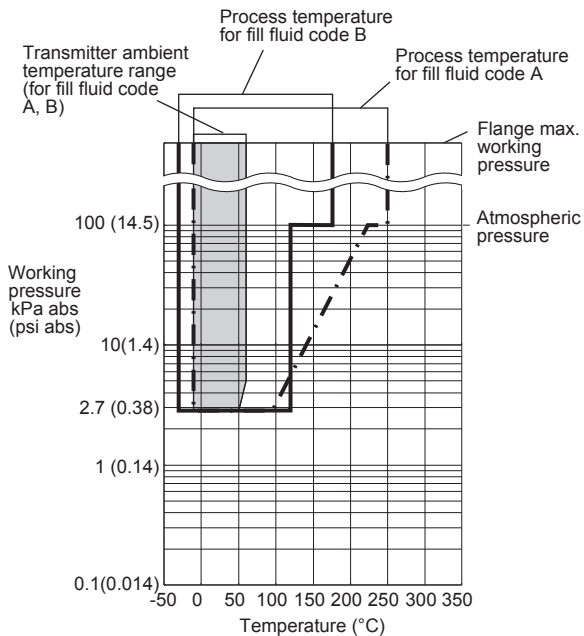

F01E.ai

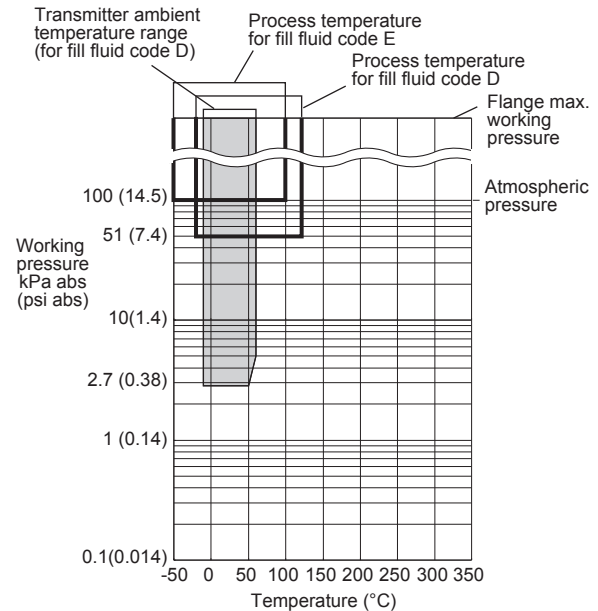

F02E.ai

**Figure 1-1. Working Pressure and Process Temperature (Fill fluid: silicone oil for general use)**

**Figure 1-2. Working Pressure and Process Temperature (Fill fluid: fluorinated oil for oil-prohibited use and ethylene glycol for low temperature use)**

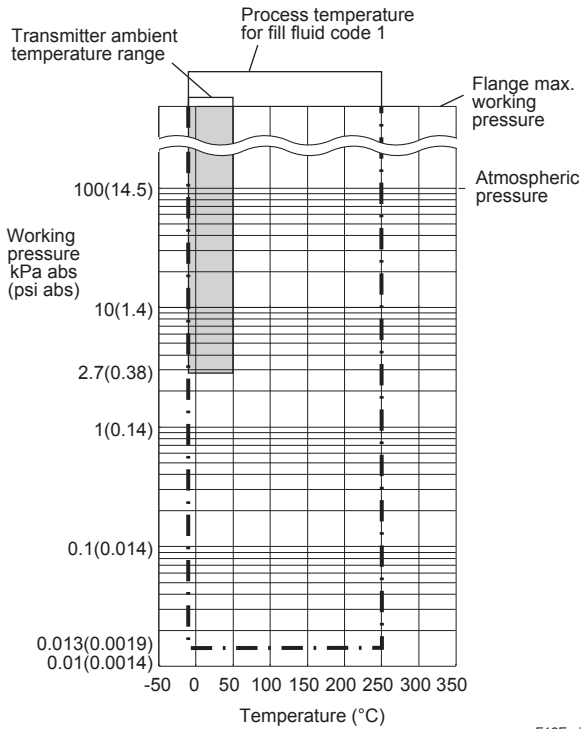

**Figure 1-3. Working Pressure and Process Temperature (Fill fluid: silicone oil for high temp. and high vacuum use)**

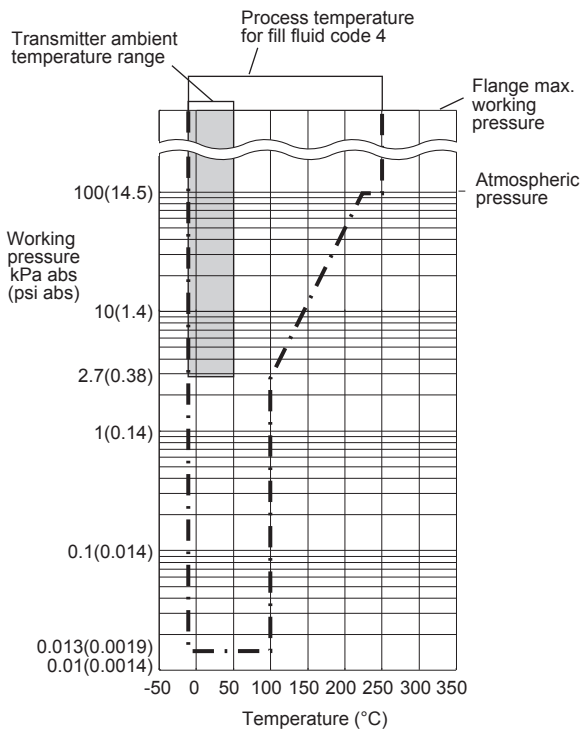

**Figure 1-4. Working Pressure and Process Temperature (Fill fluid: silicone oil for high vacuum use)**

**Supply & Load Requirements (Output signal code D and J. Optional features or approval codes may affect electrical requirements.)**

With 24 V DC supply, up to a 550 Ω load can be used. See graph below.

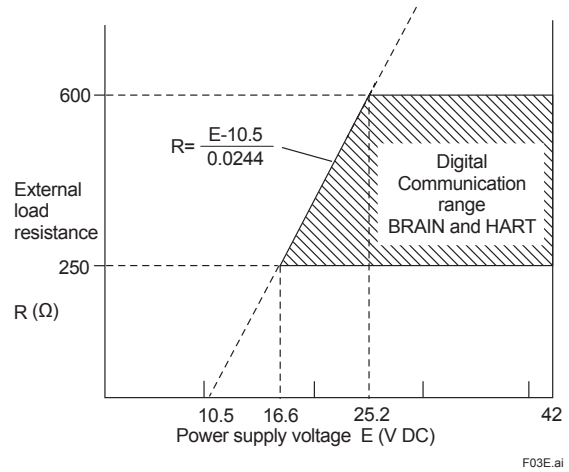

**Figure 2. Relationship Between Power Supply Voltage and External Load Resistance (Output signal code D and J)**

**Supply Voltage “◇”**

**For 4 to 20 mA HART / BRAIN (Output signal code D and J)**

10.5 to 42 V DC for general use and flameproof type.  
10.5 to 32 V DC for lightning protector (option code /A).

10.5 to 30 V DC for intrinsically safe, type n, or non-incendive.

Minimum voltage limited at 16.6 V DC for digital communications, BRAIN and HART

**For 1 to 5 V HART (Output signal code Q)**

Power supply :

9 to 28 V DC for general use and flame proof type.

Power Consumption :

0.96 mA to 3 mA, 27 mW

**Load for 4 to 20 mA HART / BRAIN (Output signal code D and J)**

0 to 1290Ω for operation

250 to 600Ω for digital communication

**Output Load for 1 to 5 V HART (Output signal code Q)**

1 MΩ or greater (meter input impedance)

Note that with three-wire connection, the cable length may affect the measurement accuracy of the output signal.

**Communication Requirements “◇”**  
(Approval codes may affect electrical requirements.)

**BRAIN**

**Communication distance**

Up to 2 km (1.25 miles) when using CEV polyethylene-insulated PVC-sheathed cables. Communication distance varies depending on type of cable used.

**Load capacitance**

0.22 µF or less

**Load inductance**

3.3 mH or less

**Input impedance of communicating device**

10 kΩ or more at 2.4 kHz.

**EMC Conformity Standards**

- EN 61326-1 Class A, Table2
- EN 61326-2-3
- EN 61326-2-5 (for fieldbus)

**European Pressure Equipment Directive 2014/68/EU**

Sound Engineering Practice

**EU RoHS Directive**

EN 50581

**Safety Requirement Standards**

- EN 61010-1, C22.2 No.61010-1
  - Installation category: I  
(Anticipated transient overvoltage 330 V)
  - Pollution degree: 2
  - Indoor/Outdoor use

□ **PHYSICAL SPECIFICATIONS**

**Process connections**

See the following table.

**Table 2. Flange size and rating**

Process connection style	Size	Flange
Adapter connection type	1/2-inch 3/4-inch 1-inch	JIS 10K, 20K, 40K ANSI Class 150, 300, 600 JPI Class 150, 300, 600
Flange connection type	1/2-inch 3/4-inch 1-inch	JIS 10K, 20K, 40K ANSI Class 150, 300, 600 JPI Class 150, 300, 600

**Gasket Contact Surface**

See the following table.

**Table 3. Gasket contact surface**

Flange		JIS/JPI		ANSI	
Wetted parts material code		SA, SD	WA, WD	SA, SD	WA, WD
Gasket contact Surface	Serration*1	—	—	●	●
	Flat (No serration)	●	●	●	●

●: Applicable, —: Not applicable

\*1: ANSI B16.5

**Electrical Connections**

See “MODEL AND SUFFIX CODES.”

**Transmitter Mounting**

2-inch pipe mounting

**Wetted Parts Material**

**Diaphragm seal**

**Diaphragm and other wetted parts;**  
Refer to “MODEL AND SUFFIX CODES.”

**Vent / drain plugs**

316 SST

**Flange Material**

Refer to “MODEL AND SUFFIX CODES.”  
(It means the material of adapter or pipe with flange.)

**Gasket for transmitter side**

316L SST with PTFE Teflon coating

**Non-wetted Parts Material**

**Transmitter body section:**

**Cover flange**

ASTM CF-8M

**Cover flange bolting**

B7 carbon steel, 316L SST or 660 SST

**Housing**

- Low copper cast aluminum alloy
- Low copper cast aluminum alloy with corrosion resistance properties (copper content ≤ 0.03%, iron content ≤ 0.15%) (optional)
- ASTM CF-8M Stainless steel (optional)

**Coating of housing**

[for aluminum housing]

Polyester resin powder coating

Mint-green paint (Munsell 5.6BG 3.3/2.9 or its equivalent)

[for option code /P□ or /X2]

Epoxy and polyurethane resin solvent coating

**Degrees of protection**

IP66/IP67, Type 4X

**Cover O-rings**

Buna-N, fluoro-rubber (optional)

**Name plate and tag**

316 SST

**Diaphragm seal section:**

**Capillary tube**

316 SST

**Protection tube**

304 SST PVC-sheathed

(Max. operating temperature of PVC, 100°C (212°F))

**Fill fluid**

See table 1.

In case of Adapter connection type

**Stud bolt... B7**

**Nut ..... 304 SST**

**Weight**

Inner diaphragm, adapter connection type: 8.8 kg

(19.4 lbs)

(1/2-inch ANSI Class150 flange, capillary length 5 m; without integral indicator and mounting bracket.)

Add 1.5kg (3.3lb) for Amplifier housing code 2.

< Related Instruments> “◇”

Power Distributor: Refer to GS 01B04T01-02E or  
GS 01B04T02-02E

BRAIN TERMINAL: Refer to GS 01C00A11-00E

< Reference >

- Teflon; Trademark of E.I. DuPont de Nemours & Co.
- Hastelloy; Trademark of Haynes International Inc.
- HART®: Registered trademark of FieldComm Group.
- Foundation Fieldbus; Trademark of FieldComm Group.
- **DPsharp EJA™**; Registered trademark of Yokogawa Electric Corporation.
- FieldMate; Registered trademark of Yokogawa Electric Corporation.
- PROFIBUS; Registered trademark of Profibus Nutzerorganisation e.v., Karlsruhe, Germany.

Other company names and product names used in this material are registered trademarks or trademarks of their respective owners.

**MODEL AND SUFFIX CODES**

• Instruction

The model and suffix codes for EJA118E consist of two parts; a transmitter body section (I) and a diaphragm seal section (II). This specification sheet introduces these two parts separately. The transmitter body section is shown in one table, and the diaphragm seal section specifications are listed according to the process connection style. First select the model and suffix codes of transmitter body section and then continue on one of the diaphragm seal section.

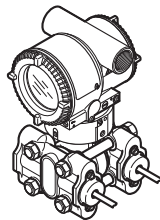
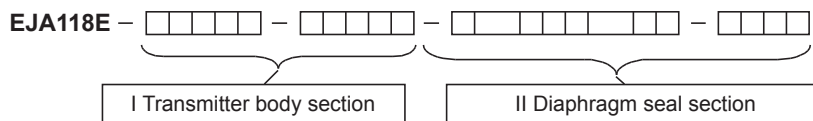

See Page 7

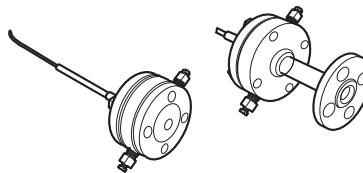

Inner diaphragm,  
Adapter connection type ••• See Page 8  
Inner diaphragm,  
Flange connection type ••• See Page 9

F04E.ai

**I. Transmitter body section**

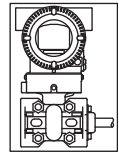
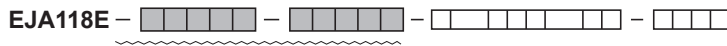

F05E.ai

Model	Suffix codes	Description
<b>EJA118E</b>	.....	Diaphragm sealed differential pressure transmitter
Output signal	<b>-D</b> .....	4 to 20 mA DC with digital communication (BRAIN protocol)
	<b>-J</b> .....	4 to 20 mA DC with digital communication (HART 5/HART 7 protocol) <sup>*1</sup>
	<b>-F</b> .....	Digital communication (FOUNDATION Fieldbus protocol, refer to GS 01C31T02-01EN)
	<b>-G</b> .....	Digital communication (PROFIBUS PA protocol, refer to GS 01C31T04-01EN)
	<b>-Q</b> .....	Low Power, 1 to 5 V DC with digital communication (HART 7 protocol) <sup>*7</sup>
Measurement span (capsule)	<b>M</b> .....	2.5 to 100 kPa (10 to 400 inH <sub>2</sub> O)
	<b>H</b> .....	25 to 500 kPa (100 to 2000 inH <sub>2</sub> O)
—	<b>S</b> .....	Always S
—	<b>C</b> .....	Always C
Coverflange bolts and nuts material	<b>J</b> .....	B7 carbon steel
	<b>G</b> .....	316L SST
	<b>C</b> .....	660 SST
Installation	<b>-9</b> .....	Horizontal piping type and left side high pressure
Amplifier housing	<b>1</b> .....	Cast aluminum alloy
	<b>3</b> .....	Cast aluminum alloy with corrosion resistance properties <sup>*2</sup>
	<b>2</b> .....	ASTM CF-8M Stainless Steel <sup>*3</sup>
Electrical connection	<b>0</b> .....	G 1/2 female, one electrical connection without blind plugs
	<b>▶ 2</b> .....	1/2 NPT female, two electrical connections without blind plugs
	<b>4</b> .....	M20 female, two electrical connections without blind plugs
	<b>5</b> .....	G 1/2 female, two electrical connections with a blind plug <sup>*4</sup>
	<b>7</b> .....	1/2 NPT female, two electrical connections with a blind plug <sup>*4</sup>
	<b>9</b> .....	M20 female, two electrical connections with a blind plug <sup>*4</sup>
	<b>A</b> .....	G1/2 female, two electrical connections and a 316 SST blind plug
	<b>C</b> .....	1/2 NPT female, two electrical connections and a 316 SST blind plug
Integral Indicator	<b>D</b> .....	Digital indicator <sup>*5</sup>
	<b>E</b> .....	Digital indicator with the range setting switch (push button) <sup>*6</sup>
	<b>▶ N</b> .....	None
Mounting bracket	<b>B</b> .....	304 SST 2-inch pipe mounting, flat type (for horizontal piping)
	<b>J</b> .....	316 SST 2-inch pipe mounting, flat type (for horizontal piping)
	<b>▶ N</b> .....	None
Diaphragm seal section	- [ ] - [ ]	Continued on diaphragm seal section (II)

The “▶” marks indicate the most typical selection for each specification.

\*1: HART 5 or HART 7 is selectable. Specify upon ordering.

\*2: Not applicable for electrical connection code **0, 5, 7, 9** and **A**.

\*3: Not applicable for electrical connection code **0, 5, 7** and **9**.

\*4: Material of a blind plug; aluminum alloy for code 5 and 9, and SUS304 for code 7.

\*5: Not applicable for output signal code **G**.

\*6: Not applicable for output signal code **F**.

\*7: As CE marking is still pending, not applicable for those countries which require CE marking.

## II. Diaphragm seal section (Inner Diaphragm, Adapter connection type)

EJA118E - □□□□ - □□□□ - A □<sup>6</sup> □<sup>7</sup> □□□□ - □□□□<sub>1</sub>

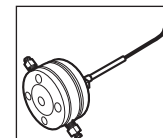

F06E.ai

Model	Suffix codes	Description	
EJA118E	-□□□□-□□□□.....	Transmitter body section (I)	
Process connection style	-A.....	Inner Diaphragm, Adapter connection type	
Flange rating	J1.....	JIS 10K	
	J2.....	JIS 20K	
	J4.....	JIS 40K	
	A1.....	ANSI class 150	P1..... JPI class 150
	A2.....	ANSI class 300	P2..... JPI class 300
	A4.....	ANSI class 600*8	P4..... JPI class 600*8
Process connection size (Process flange size)	6.....	1/2 inch (15 mm)	
	7.....	3/4 inch (20 mm)	
	1.....	1 inch (25 mm)	
Flange material*3	E.....	316 SST (Adapter material)*4	
Gasket contact surface*1	1.....	Serration (for ANSI flange only)	
	2.....	Flat (no serration)	
Wetted parts material*3	SA.....	[Diaphragm] 316L SST [Others] 316 SST (include Adapter)*4	
	WA.....	Hastelloy C-276 *5# 316 SST (include Adapter)*4#	
Flushing connection ring*2	0.....	None	
Extension	0.....	None	
Fill fluid*5	-A.....	For general use (silicone oil) [Process temperature] -10 to 250°C [Ambient temperature] -10 to 60°C	
	-B.....	For general use (silicone oil) -30 to 180°C -15 to 60°C	
	-D.....	For oil-prohibited use (fluorinated oil)*2 -20 to 120°C -10 to 60°C	
	-E.....	For low temperature use (ethylene glycol) -50 to 100°C -40 to 60°C	
	-1.....	High temp. and high vacuum use (Silicone oil) -10 to 250°C -10 to 50°C	
	-4.....	High vacuum use (Silicone oil) -10 to 100°C -10 to 50°C	
Capillary connection	B.....	Back of diaphragm seal unit	
Capillary treatment*6	1.....	Bundled capillary (1 m separated)	
	2.....	Standard	
Capillary length*7	1.....	1 m*6 6.....6 m	
	2.....	2 m 7.....7 m	
	3.....	3 m 8.....8 m	
	4.....	4 m 9.....9 m	
	5.....	5 m A.....10 m	
Option codes and Tokuchu code		/□ Optional specification and /Z	

The “▶” marks indicate the most typical selection for each specification. Example: EJA118E-DMSCG-912EN-AA16E2SA00-BB15/□/Z

\*1: See table 3 ‘Gasket contact surface’ on page 5.

\*2: Even in case where fill fluid code **D** (fluorinated oil) is selected, if degrease cleansing treatment or both degrease cleansing and dehydrating treatment for the wetted parts is required, specify option code **K1** or **K5**.

\*3: ⚠ Users must consider the characteristics of selected wetted parts material and the influence of process fluids. The use of inappropriate materials can result in the leakage of corrosive process fluids and cause injury to personnel and/or damage to plant facilities. It is also possible that the diaphragm itself can be damaged and that material from the broken diaphragm and the fill fluid can contaminate the user’s process fluids.

Be very careful with highly corrosive process fluids such as hydrochloric acid, sulfuric acid, hydrogen sulfide, sodium hypochlorite, and high-temperature steam (150°C [302°F] or above). Contact Yokogawa for detailed information of the wetted parts material.

\*4: Forged version of the material may be used.

\*5: Hastelloy C-276 or N10276.

\*6: In case where capillary length code **1** (1 m) is selected, capillary treatment must be selected code **2** (None).

\*7: In case of wetted parts material code **WA** (Hastelloy C), specify capillary length from 1 to 5m.

\*8: In case where flange rating code **A4** (ANSI class 600) or **P4** (JPI class 600) is selected, It must be selected optional code **/HP** (High pressure-proof structure).

The ‘#’ marks indicate the construction materials conform to NACE material recommendations per MR0175/ISO 15156. Please refer to the latest standards for details. Selected materials also conform to NACE MR0103.



II. Diaphragm seal section (Inner Diaphragm, Flange connection type)

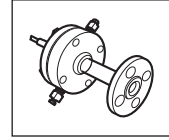
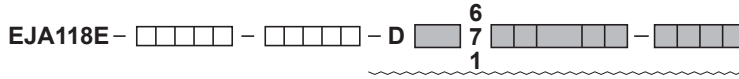

F07E.ai

Model	Suffix codes	Description
EJA118E	-□□□□□-□□□□□- D □□□□□ □□□□□ □□□□□	Transmitter body section (I)
Process connection style	-D	Inner Diaphragm, Flange connection type
Flange rating	J1	JIS 10K
	J2	JIS 20K
	J4	JIS 40K
	A1	ANSI class 150
	A2	ANSI class 300
	A4	ANSI class 600*8
	P1	JPI class 150
	P2	JPI class 300
Process connection size (Process flange size)	6	1/2 inch (15 mm)
	7	3/4 inch (20 mm)
	1	1 inch (25 mm)
Flange material*3	D	316 SST (Flange and Pipe material)*4
Gasket contact surface*1	1	Serration (for ANSI flange only)
	2	Flat (no serration)
Wetted parts material*3	SD	[Diaphragm] 316L SST [Others] 316 SST*4
	WD	Hastelloy C-276*5# 316 SST*4#
Flushing connection ring	0	None
Extension	0	None
Fill fluid	-A	For general use (silicone oil) [Process temperature] -10 to 250°C [Ambient temperature] -10 to 60°C
	-B	For general use (silicone oil) -30 to 180°C -15 to 60°C
	-D	For oil-prohibited use (fluorinated oil)*2 -20 to 120°C -10 to 60°C
	-E	For low temperature use (ethylene glycol) -50 to 100°C -40 to 60°C
	-1	High temp. and high vacuum use (Silicone oil) -10 to 250°C -10 to 50°C
	-4	High vacuum use (Silicone oil) -10 to 100°C -10 to 50°C
Capillary connection	B	Back of diaphragm seal unit
Capillary treatment*6	1	Bundled capillary (1 m separated)
	2	Standard
Capillary length*7	1	1 m*6
	2	2 m
	3	3 m
	4	4 m
	5	5 m
Option codes and Tokuchu code	6	6 m
	7	7 m
	8	8 m
	9	9 m
	A	10 m
Option codes and Tokuchu code		/ □ Optional specification and /Z

The “▶” marks indicate the most typical selection for each specification. Example: EJA118E-DMSCG-912EN-DA16D2SD00-BB15/□/Z

\*1: See table 3 ‘Gasket contact surface’ on page 5.

\*2: Even in case where fill fluid code D (fluorinated oil) is selected, if degrease cleansing treatment or both degrease cleansing and dehydrating treatment for the wetted parts is required, specify option code K1 or K5.

\*3: ⚠ Users must consider the characteristics of selected wetted parts material and the influence of process fluids. The use of inappropriate materials can result in the leakage of corrosive process fluids and cause injury to personnel and/or damage to plant facilities. It is also possible that the diaphragm itself can be damaged and that material from the broken diaphragm and the fill fluid can contaminate the user’s process fluids.  
Be very careful with highly corrosive process fluids such as hydrochloric acid, sulfuric acid, hydrogen sulfide, sodium hypochlorite, and high-temperature steam (150°C [302°F] or above). Contact Yokogawa for detailed information of the wetted parts material.

\*4: Forged version of the material may be used.

\*5: Hastelloy C-276 or N10276.

\*6: In case where capillary length code 1 (1 m) is selected, capillary treatment must be selected code 2 (None).

\*7: In case of wetted parts material code WD (Hastelloy C), specify capillary length from 1 to 5m.

\*8: In case where flange rating code A4 (ANSI class 600) or P4 (JPI class 600) is selected, it must be selected optional code /HP (High pressure-proof structure).

The ‘#’ marks indicate the construction materials conform to NACE material recommendations per MR0175/ISO 15156. Please refer to the latest standards for details. Selected materials also conform to NACE MR0103.

## ■ OPTIONAL SPECIFICATIONS (For Explosion Protected type) “◇”

For other agency approvals and marine approvals, please refer to GS 01C25A20-01EN.

Item	Description	Code
Factory Mutual (FM)	FM Explosionproof Approval <sup>**1</sup> Applicable Standard: FM3600, FM3615, FM3810, NEMA 250, ANSI/UL 61010-1, ANSI/UL 61010-2-30 Explosionproof for Class I, Division 1, Groups B, C and D, Dust-ignitionproof for Class II/III, Division 1, Groups E, F and G, in Hazardous locations, indoors and outdoors (Enclosure: Type 4X) “FACTORY SEALED, CONDUIT SEAL NOT REQUIRED.” Temperature class: T6, Amb. Temp.: -40 to 60°C (-40 to 140°F)	FF1
	FM Intrinsically safe Approval <sup>**1*3</sup> Applicable Standard: FM 3600, FM 3610, FM 3611, FM 3810, ANSI/ISA-60079-0, ANSI/ISA-60079-11, ANSI/ISA-61010-1, NEMA 250 Intrinsically Safe for Class I, Division 1, Groups A, B, C & D, Class II, Division 1, Groups E, F & G and Class III, Division 1, Class I, Zone 0, in Hazardous Locations, AEx ia IIC Nonincendive for Class I, Division 2, Groups A, B, C & D, Class II, Division. 2, Groups F & G, Class I, Zone 2, Group IIC, in Hazardous Locations Enclosure: Type 4X, Temp. Class: T4, Amb. Temp.: -60 to 60°C (-75 to 140°F) Intrinsically Safe Apparatus Parameters [Groups A, B, C, D, E, F and G] Vmax=30 V, Imax=200 mA, Pmax=1 W, Ci=6 nF, Li=0 μH [Groups C, D, E, F and G] Vmax=30 V, Imax=225 mA, Pmax=1 W, Ci=6 nF, Li=0 μH	FS1
	Combined FF1 and FS1 <sup>**1*3</sup>	FU1
ATEX	ATEX Flameproof Approval <sup>**1*3</sup> Applicable Standard: EN IEC 60079-0, EN 60079-1, EN 60079-31 Certificate: KEMA 07ATEX0109 X II 2G, 2D Ex db IIC T6...T4 Gb, Ex tb IIIC T85°C Db Degree of protection: IP66/IP67 Amb. Temp. (Tamb) for gas-proof : T4; -50 to 75°C (-58 to 167°F), T5; -50 to 80°C (-58 to 176°F), T6; -50 to 75°C (-58 to 167°F) Process Temp. for gas-proof (Tp): T4; -50 to 120°C (-58 to 248°F), T5; -50 to 100°C (-58 to 212°F), T6; -50 to 85°C (-58 to 185°F) Max. surface Temp. for dust-proof: T85°C (Tamb: -30 to 75°C, Tp: -30 to 85°C) <sup>*2</sup>	KF22
	ATEX Intrinsically safe Approval <sup>**1*3</sup> Applicable Standard: EN 60079-0, EN 60079-11 Certificate: DEKRA 11ATEX0228 X II 1G, 2D Ex ia IIC T4 Ga, Ex ia IIIC T85°C T100°C T120°C Db Degree of protection: IP66/IP67 Amb. Temp. (Tamb) for EPL Ga: -50 to 60°C (-58 to 140°F) Maximum Process Temp. (Tp) for EPL Ga: 120°C Electrical data: Ui=30 V, Ii=200 mA, Pi=0.9 W, Ci=27.6 nF, Li=0 μH Amb. Temp. for EPL Db: -30 to 60°C <sup>*2</sup> Max. surface Temp. for EPL Db: T85°C (Tp: 80°C), T100°C (Tp: 100°C), T120°C (Tp: 120°C)	KS21
	Combined KF22, KS21 and ATEX Intrinsically safe Ex ic <sup>**1*3</sup> [ATEX Intrinsically safe Ex ic] Applicable Standard: EN 60079-0, EN 60079-11 II 3G Ex ic IIC T4 Gc, Amb. Temp.: -30 to 60°C (-22 to 140°F) <sup>*2</sup> Ui=30 V, Ci=27.6 nF, Li=0 μH	KU22

Item	Description	Code
Canadian Standards Association (CSA)	<p>CSA Explosionproof Approval *1                      Certificate: 2014354                      Applicable Standard: C22.2 No. 25, C22.2 No. 30, CAN/CSA-C22.2 No. 94, CAN/CSA-C22.2 No. 61010-1, CAN/CSA-C22.2 No. 61010-2-030, CAN/CSA-C22.2 No. 60079-0, CAN/CSA-C22.2 No. 60079-1, CAN/CSA-C22.2 No. 60529                      Explosion-proof for Class I, Groups B, C and D.                      Dustignition-proof for Class II/III, Groups E, F and G.                      When installed in Division 2, "SEAL NOT REQUIRED" Enclosure: Type 4X, Temp. Code: T6...T4                      Ex d IIC T6...T4 Enclosure: IP66/IP67                      Max.Process Temp.: T4;120°C(248°F), T5;100°C(212°F), T6; 85°C(185°F)                      Amb.Temp.: -50 to 75°C(-58 to 167°F) for T4, -50 to 80°C(-58 to 176°F) for T5, -50 to 75°C(-58 to 167°F) for T6 *2                      Process Sealing Certification                      Dual Seal Certified by CSA to the requirement of ANSI/ISA-12.27.01                      No additional sealing required                      Primary seal failure annunciation: at the zero adjustment screw</p> <p>CSA Intrinsically safe Approval *1*3                      Certificate: 1606623                      [For Division System]                      Applicable Standard: C22.2 No.0, C22.2 No.94, C22.2 No.157, C22.2 No.213, C22.2 No.61010-1, C22.2 No.61010-2-030                      Intrinsically Safe for Class I, Division 1, Groups A, B, C &amp; D, Class II, Division 1, Groups E, F &amp; G, Class III, Division 1, Nonincendive for Class I, Division 2, Groups A, B, C &amp; D, Class II, Division 2, Groups F &amp; G, Class III, Division 1                      Enclosure: Type 4X, Temp. Code: T4 Amb. Temp.: -50 to 60°C(-58 to 140°F) *2                      Electrical Parameters: [Intrinsically Safe] Vmax=30V, Imax=200mA, Pmax=0.9W, Ci=10nF, Li=0 μH [Nonincendive] Vmax=30V, Ci=10nF, Li=0 μH                      [For Zone System]                      Applicable Standard: CAN/CSA-C22.2 60079-0, CAN/CSA-E60079-11, CAN/CSA-E60079-15, CAN/CSA-C22.2 No.60529                      Ex ia IIC T4, Ex nL IIC T4 Enclosure: IP66/IP67                      Amb. Temp.: -50 to 60°C(-58 to 140°F) *2, Max. Process Temp.: 120°C(248°F)                      Electrical Parameters: [Ex ia] Ui=30V, li=200mA, Pi=0.9W, Ci=10nF, Li=0 μH [Ex nL] Ui=30V, Ci=10nF, Li=0 μH                      Process Sealing Certification                      Dual Seal Certified by CSA to the requirement of ANSI/ISA-12.27.01                      No additional sealing required                      Primary seal failure annunciation: at the zero adjustment screw</p> <p>Combined CF1 and CS1 *1*3</p>	<p>CF1</p> <p>CS1</p> <p>CU1</p>
IECEx	<p>IECEx Flameproof Approval *1                      Applicable Standard: IEC 60079-0, IEC60079-1                      Certificate: IECEx CSA 07.0008                      Flameproof for Zone 1, Ex d IIC T6...T4 Gb Enclosure: IP66/IP67                      Max.Process Temp.: T4;120°C(248°F), T5;100°C(212°F), T6; 85°C(185°F)                      Amb.Temp.: -50 to 75°C(-58 to 167°F) for T4, -50 to 80°C(-58 to 176°F) for T5, -50 to 75°C(-58 to 167°F) for T6</p> <p>IECEx Intrinsically safe and Flameproof Approval *1*3                      Intrinsically safe Ex ia                      Certificate: IECEx DEK 11.0081X                      Applicable Standard: IEC 60079-0, IEC 60079-11                      Ex ia IIC T4 Ga Enclosure: IP66/IP67                      Amb. Temp.: -50 to 60 °C(-58 to 140 °F), Max. Process Temp.: 120 °C(248 °F)                      Electrical Parameters: Ui=30 V, li=200 mA, Pi=0.9 W, Ci=27.6 nF, Li=0 μH                      Intrinsically safe Ex ic                      Certificate: IECEx DEK 13.0061X                      Applicable Standard: IEC 60079-0, IEC 60079-11                      Ex ic IIC T4 Gc IP code: IP66                      Amb. Temp.: -30 to 60°C(-22 to 140°F) *2, Max. Process Temp.: 120°C(248°F)                      Electrical Parameters: Ui=30V,Ci=27.6 nF, Li=0 μH                      Flameproof                      Certificate: IECEx CSA 07.0008                      Applicable Standard: IEC 60079-0, IEC60079-1                      Flameproof for Zone 1, Ex d IIC T6...T4 Gb Enclosure: IP66/IP67                      Max.Process Temp.: T4;120°C(248°F), T5;100°C(212°F), T6; 85°C(185°F)                      Amb.Temp.: -50 to 75°C(-58 to 167°F) for T4, -50 to 80°C(-58 to 176°F) for T5, -50 to 75°C(-58 to 167°F) for T6</p>	<p>SF2</p> <p>SU21</p>

\*1: Applicable for Electrical connection code **2, 4, 7, 9, C** and **D**.  
 \*2: Lower limit of ambient temperature is -15°C (5°F) when **/HE** is specified.  
 \*3: Not applicable for output signal code **Q**.

■ OPTIONAL SPECIFICATIONS

Item		Description	Code
Painting	Color change	Amplifier cover only*1	P□
	Coating change	Amplifier cover and terminal cover, Munsell 7.5 R4/14	PR
		Anti-corrosion coating*2	X2
316 SST exterior parts		316 SST zero-adjustment screw and setscrews*3	HC
Fluoro-rubber O-ring		All O-rings of amplifier housing. Lower limit of ambient temperature: -15°C (5°F)	HE
Lightning protector		Transmitter power supply voltage: 10.5 to 32 V DC ( 10.5 to 30 V DC for intrinsically safe type.) Allowable current: Max. 6000 A ( 1 × 40 μs ), Repeating 1000 A ( 1 × 40 μs ) 100 times Applicable Standards: IEC 61000-4-4, IEC 61000-4-5	A
Oil-prohibited use		Degrease cleansing treatment	K1
Oil-prohibited use with dehydrating treatment		Degrease cleansing treatment and dehydrating treatment	K5
Calibration units *4	P calibration (psi unit)	(See table for Span and Range Limits.)	D1
	bar calibration (bar unit)		D3
	M calibration (kgf/cm <sup>2</sup> unit)		D4
Operating temperature correction *5		Adjusting range : 80°C to Maximum temperature of specified fill fluid	R
Capillary without PVC sheaths		When ambient temperature exceeds 100°C, or use of PVC is prohibited	V
Output limits and failure operation *6	Failure alarm down-scale : Output status at CPU failure and hardware error is -5%, 3.2 mA DC or less for 4 to 20 mA output type, and -5%, 0.8V DC or less for 1 to 5 V output type.		C1
	NAMUR NE43 Compliant Output signal limits: 3.8 mA to 20.5 mA *11	Failure alarm down-scale : Output status at CPU failure and hardware error is -5%, 3.2 mA DC or less.	C2
		Failure alarm up-scale : Output status at CPU failure and hardware error is 110%, 21.6 mA or more.	C3
Gold-plated diaphragm		Inside of isolating diaphragms (fill fluid side) are gold plated, effective for hydrogen permeation.	A1
Wired tag plate		316 SST tag plate wired onto transmitter (Tag No.: Maximum. 16 characters.)	N4
Data configuration at factory *7	Data configuration for HART communication type	Software damping, Descriptor, Message	CA
	Data configuration for BRAIN communication type	Software damping	CB
Material certificate	Adapter (Flange), Block	Adapter connection type	M2A
	Adapter (Flange), Block, Bolt for Block, Stud bolt and nut, Bolt and nut for cover flange		M8A
	Flange, Base, Block, Pipe	Flange connection type	M2D
	Flange, Base, Block, Pipe, Bolt for block, Bolt and nut for cover flange		M8D
Pressure test/Leak test Certificate *8	(Flange rating)	(Test pressure)	
	JIS 10K	2 MPa (290 psi)	Nitrogen Gas*9 Retention time: one minute
	JIS 20K	5 MPa (720 psi)	
	JIS 40K	10 MPa (1450 psi)	
	ANSI/JPI Class 150	3 MPa (430 psi)	
	ANSI/JPI Class 300	8 MPa (1160 psi)	
	ANSI/JPI Class 600	16 MPa (2300 psi)	
Long Vent		For inner diaphragm use only. Total length: 119 mm (standard: 34 mm); Total length when combining with option code K1, K2, K5, and K6: 130 mm. Material: 316 SST	U2
High pressure-proof structure*10		High pressure-proof structure for ANSI/JPI class 600 flange.	HP
Parameter list*12		List of setting and adjustment parameters	YP

- \*1: Not applicable for amplifier housing code **2** and **3**.
- \*2: Not applicable with color change option. Not applicable for amplifier housing code **2**.
- \*3: 316 or 316L SST. The specification is included in amplifier housing code **2**.
- \*4: The unit of MWP (Max. working pressure) on the name plate of a housing is the same unit as specified by option code **D1**, **D3**, and **D4**.
- \*5: Specify the process operating temperature for zero correction. Example: Zero correction by process temperature 90°C.
- \*6: Applicable for output signal code **D** and **J**. The hardware error indicates faulty amplifier or capsule.
- \*7: Also see 'Ordering Information.'
- \*8: The unit on the certificate is always MPa regardless of selection of option code **D1**, **D3**, or **D4**.
- \*9: Dry nitrogen gas is used for oil-prohibited use (option code **K1** and **K5**.)
- \*10: In case where flange rating code **A4** (ANSI class 600) or **P4** (JPI class 600) is selected, optional code **/HP** (High pressure-proof structure) must be selected.
- \*11: The 1 to 5 V voltage output corresponding to 4 to 20 mA current output is applied to output signal code Q which is non-compliant to NAMUR NE43.
- \*12: Applicable for output signal code D and J.

## DIMENSIONS

### Transmitter body section

Unit: mm (Approx.: inch)

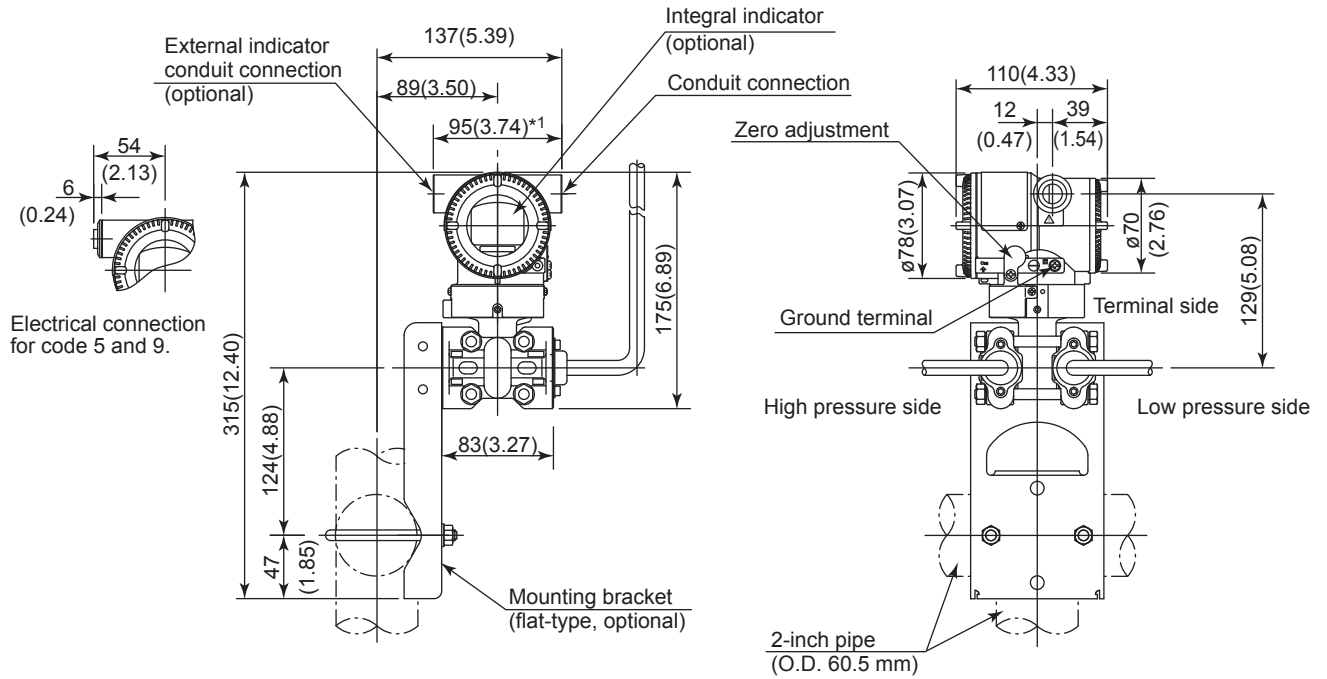

\*1: When electrical connection code 7 or C is selected, a blind plug is protruded upto 8 mm (0.31 inch) from the conduit connection.

### Terminal Configuration

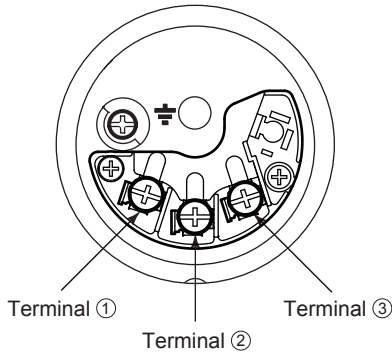

### Terminal Wiring for 4 to 20 mA output, FOUNDATION Fieldbus and PROFIBUS PA communication types

SUPPLY	+	①	Power supply and output terminals
	-	②	
CHECK	+	③	External indicator (ammeter) terminals*1*2
	-	②	
			⏏ Ground terminal

\*1: When using an external indicator or check meter, the internal resistance must be 10 Ω or less.

\*2: Not available for FOUNDATION Fieldbus and PROFIBUS PA communication types.

### Terminal Wiring for 1 to 5 V output

SUPPLY	+	①	Power supply terminals
	-	②	
VOUT	+	③	1 to 5 V DC with HART communication terminals
	-	②	
			⏏ Ground terminal

Three or four wire connection. For four wire connection, both supply and signal lines use SUPPLY - terminal.

F08E.ai

<Diaphragm seal section>

• Adapter connection type

Unit: mm (Approx.: inch)

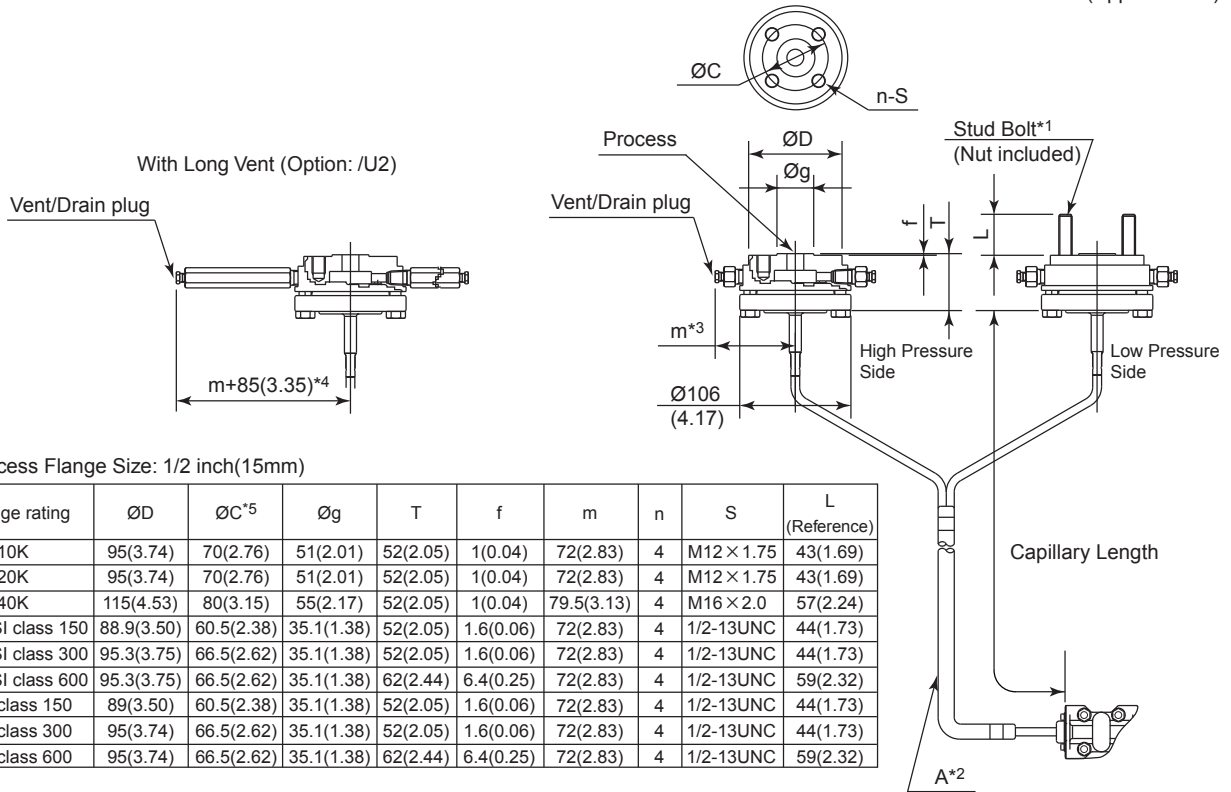

Process Flange Size: 1/2 inch(15mm)

Flange rating	ØD	ØC*5	Øg	T	f	m	n	S	L (Reference)
JIS 10K	95(3.74)	70(2.76)	51(2.01)	52(2.05)	1(0.04)	72(2.83)	4	M12×1.75	43(1.69)
JIS 20K	95(3.74)	70(2.76)	51(2.01)	52(2.05)	1(0.04)	72(2.83)	4	M12×1.75	43(1.69)
JIS 40K	115(4.53)	80(3.15)	55(2.17)	52(2.05)	1(0.04)	79.5(3.13)	4	M16×2.0	57(2.24)
ANSI class 150	88.9(3.50)	60.5(2.38)	35.1(1.38)	52(2.05)	1.6(0.06)	72(2.83)	4	1/2-13UNC	44(1.73)
ANSI class 300	95.3(3.75)	66.5(2.62)	35.1(1.38)	52(2.05)	1.6(0.06)	72(2.83)	4	1/2-13UNC	44(1.73)
ANSI class 600	95.3(3.75)	66.5(2.62)	35.1(1.38)	62(2.44)	6.4(0.25)	72(2.83)	4	1/2-13UNC	59(2.32)
JPI class 150	89(3.50)	60.5(2.38)	35.1(1.38)	52(2.05)	1.6(0.06)	72(2.83)	4	1/2-13UNC	44(1.73)
JPI class 300	95(3.74)	66.5(2.62)	35.1(1.38)	52(2.05)	1.6(0.06)	72(2.83)	4	1/2-13UNC	44(1.73)
JPI class 600	95(3.74)	66.5(2.62)	35.1(1.38)	62(2.44)	6.4(0.25)	72(2.83)	4	1/2-13UNC	59(2.32)

Process Flange Size: 3/4 inch(20mm)

Flange rating	ØD	ØC*5	g	T	f	m	n	S	L (Reference)
JIS 10K	100(3.94)	75(2.95)	56(2.20)	52(2.05)	1(0.04)	72(2.83)	4	M12×1.75	43(1.69)
JIS 20K	100(3.94)	75(2.95)	56(2.20)	52(2.05)	1(0.04)	72(2.83)	4	M12×1.75	43(1.69)
JIS 40K	120(4.72)	85(3.35)	60(2.36)	52(2.05)	1(0.04)	82(3.23)	4	M16×2.0	57(2.24)
ANSI class 150	98.6(3.88)	69.9(2.75)	42.9(1.69)	52(2.05)	1.6(0.06)	72(2.83)	4	1/2-13UNC	44(1.73)
ANSI class 300	117.3(4.62)	82.6(3.25)	42.9(1.69)	52(2.05)	1.6(0.06)	80.7(3.18)	4	5/8-11UNC	51(2.01)
ANSI class 600	117.3(4.62)	82.6(3.25)	42.9(1.69)	62(2.44)	6.4(0.25)	80.7(3.18)	4	5/8-11UNC	67(2.64)
JPI class 150	99(3.90)	69.8(2.75)	42.9(1.69)	52(2.05)	1.6(0.06)	72(2.83)	4	1/2-13UNC	44(1.73)
JPI class 300	117(4.61)	82.6(3.25)	42.9(1.69)	52(2.05)	1.6(0.06)	80.7(3.18)	4	5/8-11UNC	51(2.01)
JPI class 600	117(4.61)	82.6(3.25)	42.9(1.69)	62(2.44)	6.4(0.25)	80.7(3.18)	4	5/8-11UNC	67(2.64)

Process Flange Size: 1 inch(25mm)

Flange rating	ØD	ØC*5	Øg	T	f	m	n	S	L (Reference)
JIS 10K	125(4.92)	90(3.54)	67(2.64)	52(2.05)	1(0.04)	84.5(3.33)	4	M16×2.0	57(2.24)
JIS 20K	125(4.92)	90(3.54)	67(2.64)	52(2.05)	1(0.04)	84.5(3.33)	4	M16×2.0	57(2.24)
JIS 40K	130(5.12)	95(3.74)	70(2.76)	52(2.05)	1(0.04)	87(3.43)	4	M16×2.0	57(2.24)
ANSI class 150	108(4.25)	79.2(3.12)	50.8(2.00)	52(2.05)	1.6(0.06)	76(2.99)	4	1/2-13UNC	44(1.73)
ANSI class 300	124(4.88)	88.9(3.50)	50.8(2.00)	52(2.05)	1.6(0.06)	84(3.31)	4	5/8-11UNC	51(2.01)
ANSI class 600	124(4.88)	88.9(3.50)	50.8(2.00)	62(2.44)	6.4(0.25)	84(3.31)	4	5/8-11UNC	67(2.64)
JPI class 150	108(4.25)	79.2(3.12)	50.8(2.00)	52(2.05)	1.6(0.06)	76(2.99)	4	1/2-13UNC	44(1.73)
JPI class 300	124(4.88)	88.9(3.50)	50.8(2.00)	52(2.05)	1.6(0.06)	84(3.31)	4	5/8-11UNC	51(2.01)
JPI class 600	124(4.88)	88.9(3.50)	50.8(2.00)	62(2.44)	6.4(0.25)	84(3.31)	4	5/8-11UNC	67(2.64)

\*1: Stud bolts and nuts are attached for 2×n pcs.

\*2: When selecting "Capillary treatment code 1," the capillaries are bundled at "A" while having 1m separated capillaries for remote seals.

\*3: In case of oil-prohibited use or oil-prohibited use with dehydrating treatment, 15mm added.

\*4: In case of oil-prohibited use or oil-prohibited use with dehydrating treatment, 11mm added.

\*5: This value is the same as flange standards. Actual value might be added 1mm(0.04inch) because the commercial gaskets can be used.

F09E.ai

● Flange connection type

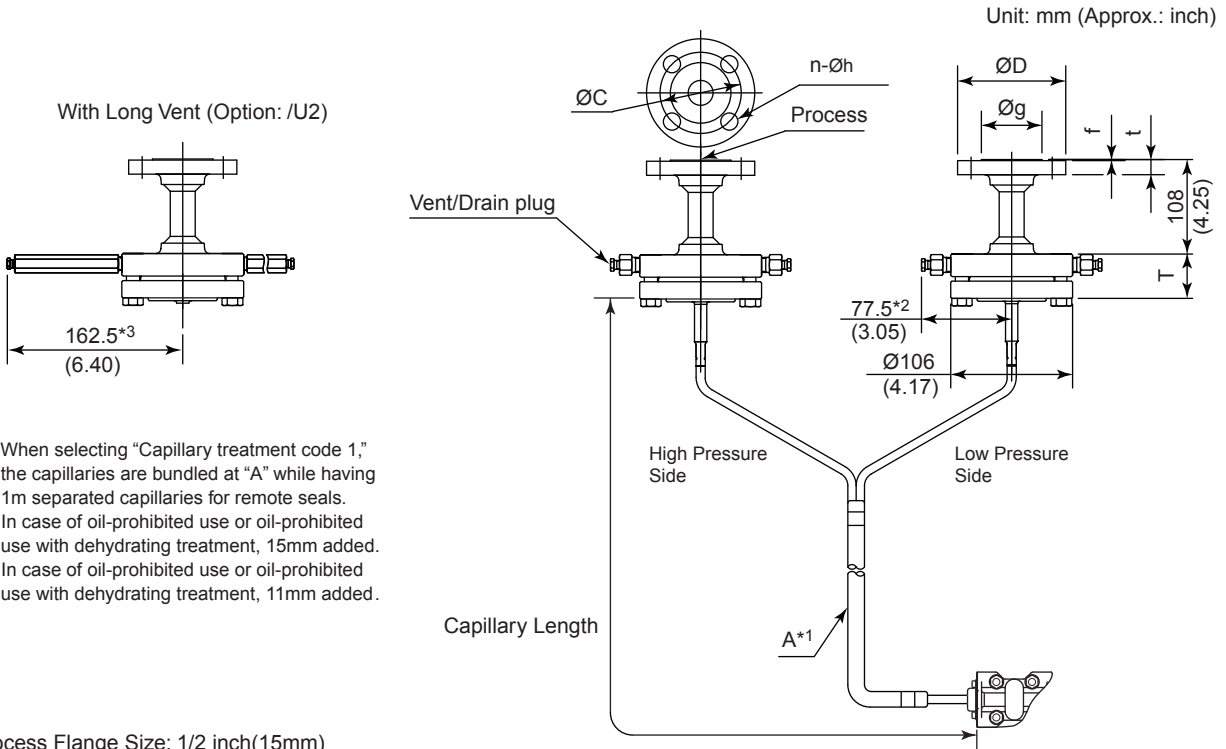

- \*1: When selecting "Capillary treatment code 1," the capillaries are bundled at "A" while having 1m separated capillaries for remote seals.
- \*2: In case of oil-prohibited use or oil-prohibited use with dehydrating treatment, 15mm added.
- \*3: In case of oil-prohibited use or oil-prohibited use with dehydrating treatment, 11mm added.

Process Flange Size: 1/2 inch(15mm)

Flange rating	ØD	ØC	Øg	T	t	f	n	Øh
JIS 10K	95(3.74)	70(2.76)	51(2.01)	42(1.65)	12(0.47)	1(0.04)	4	15(0.59)
JIS 20K	95(3.74)	70(2.76)	51(2.01)	42(1.65)	14(0.55)	1(0.04)	4	15(0.59)
JIS 40K	115(4.53)	80(3.15)	55(2.17)	42(1.65)	20(0.79)	1(0.04)	4	19(0.75)
ANSI class 150	88.9(3.50)	60.5(2.38)	35.1(1.38)	42(1.65)	11.2(0.44)	1.6(0.06)	4	15.7(0.62)
ANSI class 300	95.3(3.75)	66.5(2.62)	35.1(1.38)	42(1.65)	14.3(0.56)	1.6(0.06)	4	15.7(0.62)
ANSI class 600	95.3(3.75)	66.5(2.62)	35.1(1.38)	57(2.24)	20.7(0.81)	6.4(0.25)	4	15.7(0.62)
JPI class 150	89(3.50)	60.5(2.38)	35.1(1.38)	42(1.65)	11.2(0.44)	1.6(0.06)	4	16(0.63)
JPI class 300	95(3.74)	66.5(2.62)	35.1(1.38)	42(1.65)	14.3(0.56)	1.6(0.06)	4	16(0.63)
JPI class 600	95(3.74)	66.5(2.62)	35.1(1.38)	57(2.24)	20.7(0.81)	6.4(0.25)	4	16(0.63)

Process Flange Size: 3/4 inch(20mm)

Flange rating	ØD	ØC	Øg	T	t	f	n	Øh
JIS 10K	100(3.94)	75(2.95)	56(2.20)	42(1.65)	14(0.55)	1(0.04)	4	15(0.59)
JIS 20K	100(3.94)	75(2.95)	56(2.20)	42(1.65)	16(0.63)	1(0.04)	4	15(0.59)
JIS 40K	120(4.72)	85(3.35)	60(2.36)	42(1.65)	20(0.79)	1(0.04)	4	19(0.75)
ANSI class 150	98.6(3.88)	69.9(2.75)	42.9(1.69)	42(1.65)	12.7(0.50)	1.6(0.06)	4	15.7(0.62)
ANSI class 300	117.3(4.62)	82.6(3.25)	42.9(1.69)	42(1.65)	15.8(0.62)	1.6(0.06)	4	19.1(0.75)
ANSI class 600	117.3(4.62)	82.6(3.25)	42.9(1.69)	57(2.24)	22.2(0.87)	6.4(0.25)	4	19.1(0.75)
JPI class 150	99(3.90)	69.8(2.75)	42.9(1.69)	42(1.65)	12.7(0.50)	1.6(0.06)	4	16(0.63)
JPI class 300	117(4.61)	82.6(3.25)	42.9(1.69)	42(1.65)	15.8(0.62)	1.6(0.06)	4	19(0.75)
JPI class 600	117(4.61)	82.6(3.25)	42.9(1.69)	57(2.24)	22.2(0.87)	6.4(0.25)	4	19(0.75)

Process Flange Size: 1 inch(25mm)

Flange rating	ØD	ØC	Øg	T	t	f	n	Øh
JIS 10K	125(4.92)	90(3.54)	67(2.64)	42(1.65)	14(0.55)	1(0.04)	4	19(0.75)
JIS 20K	125(4.92)	90(3.54)	67(2.64)	42(1.65)	16(0.63)	1(0.04)	4	19(0.75)
JIS 40K	130(5.12)	95(3.74)	70(2.76)	42(1.65)	22(0.87)	1(0.04)	4	19(0.75)
ANSI class 150	108(4.25)	79.2(3.12)	50.8(2.00)	42(1.65)	14.3(0.56)	1.6(0.06)	4	15.7(0.62)
ANSI class 300	124(4.88)	88.9(3.50)	50.8(2.00)	42(1.65)	17.6(0.69)	1.6(0.06)	4	19.1(0.75)
ANSI class 600	124(4.88)	88.9(3.50)	50.8(2.00)	57(2.24)	24(0.95)	6.4(0.25)	4	19.1(0.75)
JPI class 150	108(4.25)	79.2(3.12)	50.8(2.00)	42(1.65)	14.3(0.56)	1.6(0.06)	4	16(0.63)
JPI class 300	124(4.88)	88.9(3.50)	50.8(2.00)	42(1.65)	17.6(0.69)	1.6(0.06)	4	19(0.75)
JPI class 600	124(4.88)	88.9(3.50)	50.8(2.00)	57(2.24)	24(0.95)	6.4(0.25)	4	19(0.75)

F10E.ai

**< Ordering Information >**

Specify the following when ordering

1. Model, suffix codes, and option codes
2. Calibration range and units:
  - 1) Calibration range can be specified with range value specifications up to 5 digits (excluding any decimal point) for low or high range limits within the range of -32000 to 32000. When reverse range is designated, specify LRV as greater than URV. When square root output mode is specified, LRV must be "0(zero)".
  - 2) Specify only one unit from the table, 'Factory setting.'
3. Select linear or square root for output mode and display mode.  
 Note: If not specified, the instrument is shipped set for linear mode.
4. Display scale and units (for transmitters equipped with the integral indicator only)  
 Specify either 0 to 100 % or 'Range and Unit' for engineering units scale:  
 Scale range can be specified with range limit specifications up to 5 digits (excluding any decimal point) for low or high range limits within the range of -32000 to 32000. Unit display consists of 6-digit, therefore, if the specified scaling unit excluding '/' is longer than 6-characters, the first 6 characters will be displayed on the unit display.
5. HART PROTOCOL  
 When output signal code is "J", specify the HART protocol revision "5" or "7".
6. TAG NO (if required)  
 Specified characters (up to 16 characters for BRAIN, 22 characters for HART, or 16 characters for /N4 tag) are engraved on the stainless steel tag plate fixed on the housing.
7. SOFTWARE TAG (for HART only, if required)  
 Specified characters (up to 32 characters) are set as "Tag" (the first 8 characters) and "Long tag"<sup>\*1</sup> (32 characters) in the amplifier memory. Use alphanumeric capital letters.  
 When the "SOFTWARE TAG" is not specified, specified "TAG NO" is set as "Tag" (the first 8 characters) and "Long tag"<sup>\*1</sup> (22 characters) in the amplifier memory.  
<sup>\*1:</sup> Applicable only when HART 7 is selected.
8. Other factory configurations (if required)  
 Specifying option code /CA or /CB will allow further configuration at factory. Following are configurable items and setting range.  
 [/CA : For HART communication type]  
 1) Descriptor(upto 16 characters)  
 2) Message (upto 30 characters)  
 3) Software damping (0.00 to 100.00 s)  
 [/CB : For BRAIN communication type]  
 1) Software damping (0.00 to 100.00 s)
9. Process fluid temperature for zero compensation (When /R is specified)

**< Factory Setting >**

Tag Number	As specified in order
Software damping <sup>*1</sup>	'2.00 s' or as specified in order
Output mode	'Linear' unless otherwise specified in order
Calibration range lower range value	As specified in order
Calibration range upper range value	As specified in order
Calibration range units	Selected from mmH <sub>2</sub> O, mmH <sub>2</sub> O(68°F), mmAq <sup>*2</sup> , mmWG <sup>*2</sup> , mmHg, Pa, hPa <sup>*2</sup> , kPa, MPa, mbar, bar, gf/cm <sup>2</sup> , kgf/cm <sup>2</sup> , inH <sub>2</sub> O, inH <sub>2</sub> O(68°F), inHg, ftH <sub>2</sub> O, ftH <sub>2</sub> O(68°F) or psi. (Only one unit can be specified)
Display setting	Designated differential pressure value specified in order. (% or user scaled value.) Display mode 'Linear' or 'Square root' is also as specified in order.
Static pressure display range	'0 to 25 MPa' for M and H capsule, absolute value. Measuring low pressure side.

- \*1: To specify these items at factory, /CA or /CB option is required.
- \*2: Not available for HART protocol type.

**< Material Cross Reference >**

ASTM	JIS
316	SUS316
F316	SUSF316
316L	SUS316L
F316L	SUSF316L
304	SUS304
F304	SUSF304
660	SUH660
B7	SNB7
CF-8M	SCS14A

**<Information on EU WEEE Directive>**

EU WEEE (Waste Electrical and Electronic Equipment) Directive is only valid in the EU.

This instrument is intended to be sold and used only as a part of equipment which is excluded from WEEE Directive, such as large-scale stationary industrial tools, a large-scale fixed installation and so on, and, therefore, subjected to the exclusion from the scope of the WEEE Directive. The instrument should be disposed of in accordance with local and national legislation/regulations.