



FFUS25-1G1I0

FFU

FLOW SENSORS

SICK
Sensor Intelligence.



Illustration may differ



Ordering information

Type	Part no.
FFUS25-1G1IO	6041739

Other models and accessories → www.sick.com/FFU

Detailed technical data

Features

Measurement principle	Ultrasonic sensor
Medium	Fluids
Nominal width measuring tube	DN 25
Process temperature	0 °C ... +80 °C
Process pressure	Max. 10 bar

Performance

Minimum flow	≥ 5 l/min ¹⁾
Maximum flow	0 l/min ... 240 l/min
Inlet zone	40 cm
Output zone	20 cm
Conductivity	No limitation
Accuracy of sensor element	2 % of final value ²⁾
Reproducibility	≤ 0.5 %
Resolution	0.03 l/min

¹⁾ At constant flow rate.

²⁾ Reference condition: Water, zero gas, measuring tube completely full, no cavitation, temperature of medium 20 °C, ambient temperature 20 °C ... 25 °C, compliance with inlet and outlet zones, warm-up time for electronics: 30 min.

Electronics

Supply voltage	18 V DC ... 30 V DC ¹⁾
Residual ripple	≤ 5 V _{pp} ²⁾
Power consumption	≤ 180 mA ³⁾
Initialization time	≤ 5 s
Protection class	III
Connection type	Round connector M12 x 1, 5-pin

¹⁾ All connections are polarity protected. All outputs are overload and short-circuit protected.

²⁾ May not exceed or fall below U_v tolerances.

³⁾ Without load.

⁴⁾ There are 100 mA for each output PNP and NPN available.

⁵⁾ Analog output and display.

Output signal	Analog output 4 mA ... 20 mA, 0 mA ... 20 mA current flow and temperature ¹⁾ 1 pulse/status output PNP/NPN-transistor output for flow rate meter, empty pipe detection, flow monitoring, dosing output, flow direction (dependent on type)
Output current	< 100 mA ⁴⁾
Output load	< 500 Ohm
Lower signal level	3.8 mA ... 4 mA
Upper signal level	20 mA ... 20.5 mA
Impuls/frequency output	0 kHz ... 10 kHz
Puls width	≤ 1 s
Signal voltage HIGH	V _s - 2 V
Signal voltage LOW	≤ 2 V
Inductive load	1 H
Capacitive load	100 nF
Response time	Filter off 100 ms, filter low 300 ms, filter medium 1 s, filter strong 4.2 s ⁵⁾

¹⁾ All connections are polarity protected. All outputs are overload and short-circuit protected.

²⁾ May not exceed or fall below U_y tolerances.

³⁾ Without load.

⁴⁾ There are 100 mA for each output PNP and NPN available.

⁵⁾ Analog output and display.

Mechanics

Process connection	G 1 ¼
Wetted parts	PPSU
Housing material	PPSU
Enclosure rating	IP67
Weight	460 g

Ambient data

Ambient operating temperature	0 °C ... +60 °C
Ambient storage temperature	-20 °C ... +70 °C

Classifications

ECl@ss 5.0	27200412
ECl@ss 5.1.4	27200412
ECl@ss 6.0	27200412
ECl@ss 6.2	27200412
ECl@ss 7.0	27200412
ECl@ss 8.0	27200412
ECl@ss 8.1	27200412
ECl@ss 9.0	27200412
ECl@ss 10.0	27200412
ECl@ss 11.0	27200412
ETIM 5.0	EC002580
ETIM 6.0	EC002580
ETIM 7.0	EC002580

UNSPSC 16.0901

41112501

Dimensional drawing (Dimensions in mm (inch))

DN 25, G 1 1/4

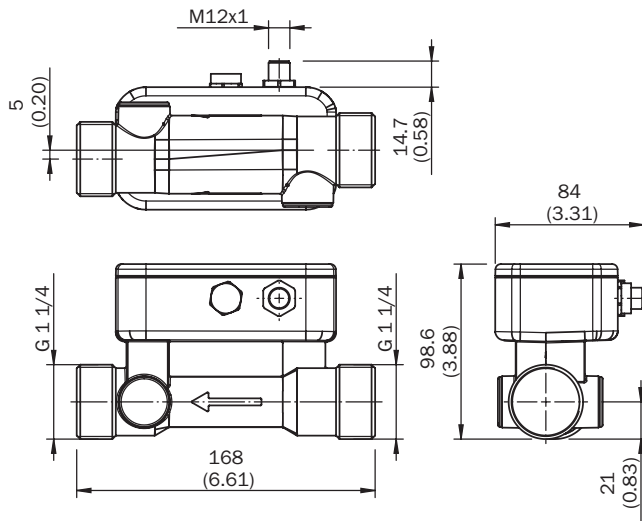

Connection type

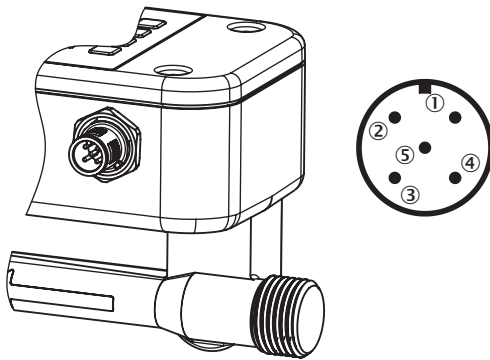

- ① L⁺: Supply voltage
- ② Q₁: Digital output PNP/NPN
- ③ M: Ground
- ④ C: Communication
- ⑤ Q_A: Analog current output

SICK AT A GLANCE

SICK is one of the leading manufacturers of intelligent sensors and sensor solutions for industrial applications. A unique range of products and services creates the perfect basis for controlling processes securely and efficiently, protecting individuals from accidents and preventing damage to the environment.

We have extensive experience in a wide range of industries and understand their processes and requirements. With intelligent sensors, we can deliver exactly what our customers need. In application centers in Europe, Asia and North America, system solutions are tested and optimized in accordance with customer specifications. All this makes us a reliable supplier and development partner.

Comprehensive services complete our offering: SICK LifeTime Services provide support throughout the machine life cycle and ensure safety and productivity.

For us, that is “Sensor Intelligence.”

WORLDWIDE PRESENCE:

Contacts and other locations –www.sick.com