

712B/714B

RTD/Thermocouple Calibrator

Calibration Manual

March 2015

© 2015 Fluke Corporation. All rights reserved. Specifications are subject to change without notice.
All product names are trademarks of their respective companies.

LIMITED WARRANTY AND LIMITATION OF LIABILITY

Each Fluke product is warranted to be free from defects in material and workmanship under normal use and service. The warranty period is three years and begins on the date of shipment. Parts, product repairs, and services are warranted for 90 days. This warranty extends only to the original buyer or end-user customer of a Fluke authorized reseller, and does not apply to fuses, disposable batteries, or to any product which, in Fluke's opinion, has been misused, altered, neglected, contaminated, or damaged by accident or abnormal conditions of operation or handling. Fluke warrants that software will operate substantially in accordance with its functional specifications for 90 days and that it has been properly recorded on non-defective media. Fluke does not warrant that software will be error free or operate without interruption.

Fluke authorized resellers shall extend this warranty on new and unused products to end-user customers only but have no authority to extend a greater or different warranty on behalf of Fluke. Warranty support is available only if product is purchased through a Fluke authorized sales outlet or Buyer has paid the applicable international price. Fluke reserves the right to invoice Buyer for importation costs of repair/replacement parts when product purchased in one country is submitted for repair in another country.

Fluke's warranty obligation is limited, at Fluke's option, to refund of the purchase price, free of charge repair, or replacement of a defective product which is returned to a Fluke authorized service center within the warranty period.

To obtain warranty service, contact your nearest Fluke authorized service center to obtain return authorization information, then send the product to that service center, with a description of the difficulty, postage and insurance prepaid (FOB Destination). Fluke assumes no risk for damage in transit. Following warranty repair, the product will be returned to Buyer, transportation prepaid (FOB Destination). If Fluke determines that failure was caused by neglect, misuse, contamination, alteration, accident, or abnormal condition of operation or handling, including overvoltage failures caused by use outside the product's specified rating, or normal wear and tear of mechanical components, Fluke will provide an estimate of repair costs and obtain authorization before commencing the work. Following repair, the product will be returned to the Buyer transportation prepaid and the Buyer will be billed for the repair and return transportation charges (FOB Shipping Point).

THIS WARRANTY IS BUYER'S SOLE AND EXCLUSIVE REMEDY AND IS IN LIEU OF ALL OTHER WARRANTIES, EXPRESS OR IMPLIED, INCLUDING BUT NOT LIMITED TO ANY IMPLIED WARRANTY OF MERCHANTABILITY OR FITNESS FOR A PARTICULAR PURPOSE. FLUKE SHALL NOT BE LIABLE FOR ANY SPECIAL, INDIRECT, INCIDENTAL OR CONSEQUENTIAL DAMAGES OR LOSSES, INCLUDING LOSS OF DATA, ARISING FROM ANY CAUSE OR THEORY.

Since some countries or states do not allow limitation of the term of an implied warranty, or exclusion or limitation of incidental or consequential damages, the limitations and exclusions of this warranty may not apply to every buyer. If any provision of this Warranty is held invalid or unenforceable by a court or other decision-maker of competent jurisdiction, such holding will not affect the validity or enforceability of any other provision.

Fluke Corporation
P.O. Box 9090
Everett, WA 98206-9090
U.S.A.

Fluke Europe B.V.
P.O. Box 1186
5602 BD Eindhoven
The Netherlands

Table of Contents

Title	Page
Introduction.....	1
Contact Fluke	1
Safety Information	1
Symbols.....	2
712B Specifications	3
DC mA Measurement	3
Ohms Measurement	3
Ohms Source.....	3
RTD Input and Output	4
General Specifications.....	5
714B Specifications	6
Thermocouple mV Input	6
Thermocouple mV Output	6
Thermocouple mA Input	6
Thermocouple Input and Output.....	6
General Specifications.....	8
Maintenance	9
Replace the Batteries	9
Clean the Product.....	9
Required Equipment.....	10
712B Performance Verification.....	11
Verify Ohms Source	11
Verify 4-Wire Ohms Measure	12
Verify 3-Wire Ohms Measure	13
Verify mA Measure.....	14
714B Performance Verification.....	16
Verify mV Source.....	16
Verify mV Measure	17
Verify TC Measure (Type K).....	18
Verify TC K Source	18
Verify mA Measure	19
712B Calibration Adjustment.....	21
Enter Manual Calibration Mode	21
Adjust Ohms Source.....	21
Adjust 50 Ω Source.....	22
Adjust 350 Ω Source.....	22

Adjust 500 Ω Source.....	23
Adjust 3500 Ω Source.....	23
Adjust Trigger Current for Ohms Measure	24
Adjust 0.1 mA Trigger Current.....	24
Adjust 0.25 mA Trigger Current.....	25
Adjust 0.5 mA Trigger Current.....	25
Adjust 1 mA Trigger Current.....	26
Adjust Ohms Measure	26
Adjust 50 Ω Input.....	27
Adjust 350 Ω Input.....	27
Adjust 500 Ω Input.....	28
Adjust 3500 Ω Input.....	28
Adjust mA Measure	29
Adjust 0.1 mA Input	29
Adjust 24 mA Input	30
Adjust External Trigger for Ohms Source.....	30
Adjust 0.1 mA External Trigger.....	31
Adjust 1 mA External Trigger.....	31
Save Data and Reset the 712B System.....	32
714B Calibration Adjustment.....	32
Enter Calibration Mode.....	32
Use 8508A to Adjust the 5522A Output.....	33
Adjust mV Source.....	33
Adjust mV Measure	34
Adjust Internal Cold Junction Temperature	35
Use the Fluke 9101-256	35
Use a Lag Bath.....	37
Adjust mA Measure	38
Save Data and Reset the 714B System.....	39
User-Replaceable Parts and Accessories.....	40

List of Tables

Table	Title	Page
1.	Symbols.....	2
2.	Required Equipment for 712B Verification and Calibration Adjustment	10
3.	Required Equipment for 714B Verification and Calibration Adjustment	10
4.	712B Ohms Source Limits.....	12
5.	712B 4-Wire Ohms Measure Limits	13
6.	712B 3-Wire Ohms Measure Limits	14
7.	712B mA Measure Limits	15
8.	714B mV Source Limits	17
9.	714B mV Measure Limits	17
10.	714B Type K Measure Limits	18
11.	714B TC K Source Limits	19
12.	714B mA Measure Limits	20
13.	User-Replaceable Parts and Accessories for 712B	40
14.	User-Replaceable Parts and Accessories for 714B	42

List of Figures

Figure	Title	Page
1.	Replace the Batteries	9
2.	Verify 712B Ohms Source	11
3.	Verify 712B 4-Wire Ohms Measure.....	12
4.	Verify 712B 3-Wire Ohms Measure.....	13
5.	Verify 712B mA Measure	15
6.	Verify 714B mV Source	16
7.	Verify 714B mV Measure	17
8.	Verify Type K Measure	18
9.	Verify mA Measure	20
10.	Adjust 712B Ohms Source	21
11.	Adjust 712B Trigger Current.....	24
12.	Adjust for 712B Ohms Measure	26
13.	Adjust 712B mA Measure.....	29
14.	Adjust External Trigger for Ohms Source.....	30
15.	Connect the 714B to the 8508A	33
16.	Adjust 714B mV Measure.....	34
17.	Connect the 714B to the Fluke 9101-256.....	36
18.	Use Lag Bath to Adjust Cold Junction Temperature	37
19.	714B and 5522A mA Channel Connections	38
20.	User-Replaceable Parts and Accessories for 712B	41
21.	User-Replaceable Parts and Accessories for 714B	43

Introduction

The Fluke 712B/714B RTD/Thermocouple Calibrator (the Product) is a handheld, battery-operated instrument that measures and sources a variety of RTDs/thermocouples. It also has an isolated channel to measure 4-20 mA.

Contact Fluke

To contact Fluke, call one of the following telephone numbers:

- Technical Support USA: 1-800-44-FLUKE (1-800-443-5853)
- Calibration/Repair USA: 1-888-99-FLUKE (1-888-993-5853)
- Canada: 1-800-36-FLUKE (1-800-363-5853)
- Europe: +31 402-675-200
- Japan: +81-3-6714-3114
- Singapore: +65-6799-5566
- Anywhere in the world: +1-425-446-5500

Or, visit Fluke's website at www.fluke.com.

To register your product, visit <http://register.fluke.com>.

To download manuals, or to view, print, or download the latest manual supplement, visit <http://us.fluke.com/usen/support/manuals>.

Safety Information

A **Warning** identifies conditions and procedures that are dangerous to the user. A **Caution** identifies conditions and procedures that can cause damage to the Product or the equipment under test.

Warning

To prevent possible electrical shock, fire, or personal injury:

- **Carefully read all instructions.**
- **Read all safety information before you use the Product.**
- **Use the Product only as specified, or the protection supplied by the Product can be compromised.**
- **Do not use the Product around explosive gas, vapor, or in damp or wet environments.**
- **Never apply more than 30 V between any two terminals, or between any terminal and earth ground.**
- **Do not use the Product if it is damaged.**
- **The battery door must be closed and locked before you operate the Product.**

- Remove all probes, test leads, and accessories before the battery door is opened.
- Remove the input signals before you clean the Product.
- Have an approved technician repair the Product.
- Replace the batteries when the low battery indicator shows to prevent incorrect measurements.









For safe operation and maintenance of the Product:

- Repair the Product before use if the batteries leak.
- Remove the batteries if the Product is not used for an extended period of time, or if stored in temperatures that exceed the specification of the battery manufacturer. If the batteries are not removed, battery leakage can damage the Product.

Symbols

Symbols used on the Product or in this manual are shown in Table 1.

Table 1. Symbols

Symbol	Description
	Earth Ground
	Battery
	Conforms to relevant Australian Standards.
	Risk of danger. Important information. See Manual.
	Inspected and licensed by TÜV Product Services.
	Conforms to European Union directives.
CAT II	MEASUREMENT CATEGORY II is applicable to test and measuring circuits connected directly to utilization points (socket outlets and similar points) of the low voltage MAINS installation.
CAT III	MEASUREMENT CATEGORY III is applicable to test and measuring circuits connected to the distribution part of the building's low-voltage MAINS installation.
CAT IV	MEASUREMENT CATEGORY IV is applicable to test and measuring circuits connected at the source of the building's low voltage MAINS installation.
	Conforms to relevant North American Safety Standards.
	Conforms to relevant South Korean EMC Standards.
	This Product complies with the WEEE Directive (2002/96/EC) marking requirements. The affixed label indicates that you must not discard this electrical/electronic product in domestic household waste. Product Category: With reference to the equipment types in the WEEE Directive Annex I, this product is classed as category 9 "Monitoring and Control Instrumentation" product. Do not dispose of this product as unsorted municipal waste. Go to Fluke's website for recycling information.

712B Specifications

Specifications are based on a one year calibration cycle and apply from +18 °C to +28 °C unless stated otherwise. All specifications assume a 5 minute warmup period.

DC mA Measurement

Range	Resolution	Accuracy (% of Reading + Floor)	
		1 Year	2 Year
0-24 mA	0.001 mA	0.01 % + 2 μ A	0.02 % + 4 μ A
<ul style="list-style-type: none"> • Notes: • Temperature coefficient: $\pm(0.002\% \text{ of reading} + 0.002\% \text{ of range}) / ^\circ\text{C}$ ($<18\text{ }^\circ\text{C}$ or $>28\text{ }^\circ\text{C}$) 			

Ohms Measurement

Range	Resolution	Accuracy (% of Reading + Floor)	
		1 Year	2 Year
0.00 Ω to 400.00 Ω	0.01 Ω	0.015 % + 0.05 Ω	0.03 % + 0.08 Ω
400.0 Ω to 4000.0 Ω	0.1 Ω	0.015 % + 0.5 Ω	0.03 % + 0.8 Ω
<ul style="list-style-type: none"> • Notes: • Reading accuracy is based on 4-wire input. For 3-wire ohm measurements, assuming all three leads are matched, add 0.05 Ω (0.00 Ω~400.00 Ω), 0.2 Ω (400.0 Ω~4000.0 Ω) to the specifications. • Temperature Coefficient: $\pm(0.002\% \text{ of reading} + 0.002\% \text{ of range}) / ^\circ\text{C}$ ($<18\text{ }^\circ\text{C}$ or $>28\text{ }^\circ\text{C}$) 			

Ohms Source

Ohms Range	Excitation Current from Measurement Device	Accuracy (% of Output + Floor)	
		1 Year	2 Year
1.00 Ω to 400.00 Ω	0.1 mA to 0.5 mA	0.015 % + 0.1 Ω	0.03 % + 0.2 Ω
	0.5 mA to 3 mA	0.015 % + 0.05 Ω	0.03 % + 0.08 Ω
400.0 Ω to 1500.0 Ω	0.05 mA to 0.8 mA	0.015 % + 0.5 Ω	0.03 % + 0.8 Ω
1500.0 Ω to 4000.0 Ω	0.05 mA to 0.4 mA	0.015 % + 0.5 Ω	0.03 % + 0.8 Ω
Resolution			
1.00 Ω to 400.00 Ω	0.01 Ω		
400.0 Ω to 4000.0 Ω	0.1 Ω		
<ul style="list-style-type: none"> • Notes: • Supports pulsed transmitters and PLCs with pulse times as short as 5 ms. • Temperature coefficient: $\pm(0.002\% \text{ of output} + 0.002\% \text{ of range}) / ^\circ\text{C}$ ($<18\text{ }^\circ\text{C}$ or $>28\text{ }^\circ\text{C}$) 			

RTD Input and Output

RTD Type (α)	Range (°C)	Measure (°C)			Source (°C)	
		1 Year	2 Year	Source Current	1 Year	2 Year
10 Ω Pt(385)	-200 to 100	1.5	3	1 mA	1.5	3
	100 to 800	1.8	3.6	1 mA	1.8	3.6
50 Ω Pt(385)	-200 to 100	0.4	0.7	1 mA	0.4	0.7
	100 to 800	0.5	0.8	1 mA	0.5	0.8
100 Ω Pt(385)	-200 to 100	0.2 °C	0.4 °C	1 mA	0.2 °C	0.4 °C
	100 to 800	0.015 %+0.18 °C	0.03 %+0.36 °C		0.015 %+0.18 °C	0.03 %+0.36 °C
200 Ω Pt(385)	-200 to 100	0.2 °C	0.4 °C	500 μ A	0.2 °C	0.4 °C
	100 to 630	0.015 %+0.18 °C	0.03 %+0.36 °C		0.015 %+0.18 °C	0.03 %+0.36 °C
500 Ω Pt(385)	-200 to 100	0.3 °C	0.6 °C	250 μ A	0.3 °C	0.6 °C
	100 to 630	0.015 %+0.28 °C	0.03 %+0.56 °C		0.015 %+0.28 °C	0.03 %+0.56 °C
1000 Ω Pt(385)	-200 to 100	0.2 °C	0.4 °C	250 μ A	0.2 °C	0.4 °C
	100 to 630	0.015 %+0.18 °C	0.03 %+0.36 °C		0.015 %+0.18 °C	0.03 %+0.36 °C
100 Ω Pt(3916)	-200 to 100	0.2 °C	0.4 °C	1 mA	0.2 °C	0.4 °C
	100 to 630	0.015 %+0.18 °C	0.03 %+0.36 °C		0.015 %+0.18 °C	0.03 %+0.36 °C
100 Ω Pt(3926)	-200 to 100	0.2 °C	0.4 °C	1 mA	0.2 °C	0.4 °C
	100 to 630	0.015 %+0.18 °C	0.03 %+0.36 °C		0.015 %+0.18 °C	0.03 %+0.36 °C
10 Ω Cu(427)	-100 to 260	1.5	3	1 mA	1.5	3
120 Ω Ni(672)	-80 to 260	0.15	0.3	1 mA	0.15	0.3
50 Ω Cu(427)	-180 to 200	0.4	0.7	1 mA	0.4	0.7
100 Ω Cu(427)	-180 to 200	0.2	0.4	1 mA	0.2	0.4
YSI400	15 to 50	0.2	0.4	250 μ A	0.2	0.4
100 Ω Pt(3902)	-200 to 100	0.2 °C	0.4 °C	1 mA	0.2 °C	0.4 °C
	100 to 500	0.015 %+0.18 °C	0.03 %+0.36 °C		0.015 %+0.18 °C	0.03 %+0.36 °C
<ul style="list-style-type: none"> Notes: Sensor inaccuracies not included. Resolution: 0.1 °C. Read accuracy is based on 4-wire input. For 3-wire RTD measurements, assuming all three RTD leads are matched, add 1.0 °C (Pt10 and Cu10), 0.6 °C (Pt50 and Cu50), 0.4 °C (Other RTD types) to the specifications. Source Accuracy in source mode is based on 0.5 mA~3 mA (1.00 Ω~400.00 Ω), 0.05 mA~0.8 mA (400.0 Ω~1500.0 Ω), 0.05 mA~0.4 mA (1500.0 Ω~4000.0 Ω), excitation current (0.25 mA for Pt1000 range). Temperature Coefficient: ± 0.05 °C / °C (<18 °C or >28 °C) for both measure and source. Supports pulsed transmitters and PLCs with pulse times as short as 5 ms. 						

General Specifications

Maximum voltage applied between any terminal and earth ground or between any two terminals:	30 V
Operating temperature	-10 °C to 50 °C
Storage temperature	-20 °C to 60 °C
Operating altitude	2,000 meters
Storage altitude	12,000 meters
Relative Humidity (% RH operating without condensation)	Non condensing 90 % (10 °C to 30 °C) 75 % (30 °C to 40 °C) 45 % (40 °C to 50 °C) (Without condensation)
Vibration Requirements	MIL-T-28800E, Class 2
Drop Test Requirements	1 meter
IP Rating	IEC 60529: IP52
Electromagnetic Environment	IEC 61326-1, Portable FCC: CFR Title 47, Part 15, Subpart B
Safety	IEC 61010-1, Max 30 V to earth, Pollution Degree 2
Electromagnetic Compatibility	Applies to use in Korea only. Class A Equipment (Industrial Broadcasting & Communication Equipment) This product meets requirements for industrial (Class A) electromagnetic wave equipment and the seller or user should take notice of it. This equipment is intended for use in business environments and is not to be used in homes.
Power Supply	4 AA alkaline batteries/NEDA code: 15A, IEC code: LR6
Size (H x W x L)	52.5 x 84 x 188.5 mm
Weight	524 g

714B Specifications

Specifications are based on a one year calibration cycle and apply from +18 °C to +28 °C unless stated otherwise. All specifications assume a 5 minute warmup period.

Thermocouple mV Input

Range	Resolution	Accuracy (% of Reading + Floor)	
		1 Year	2 Year
-10 mV to 75 mV	0.001 mV	0.015 % + 10 µV	0.02 % + 15 µV
Temperature coefficient: ±(0.002 % of reading + 0.002 % of range) /°C (<18 °C or >28 °C)			

Thermocouple mV Output

Range	Resolution	Accuracy (% of Output + Floor)	
		1 Year	2 Year
-10 mV to 75 mV	0.01 mV	0.015 % + 10 µV	0.02 % + 15 µV
Temperature Coefficient: ± (0.002 % of output + 0.002 % of range) /°C (<18 °C or >28 °C)			

Thermocouple mA Input

Range	Resolution	Accuracy (% of Reading + Floor)	
		1 Year	2 Year
0 mA to 24 mA	0.001 mA	0.01 % + 2 µA	0.02 % + 4 µA
Temperature Coefficient: ± (0.002 % of output + 0.002 % of range) /°C (<18 °C or >28 °C)			

Thermocouple Input and Output

TC Type	Range	Measure (°C)		Source (°C)	
		1 Year	2 Year	1 Year	2 Year
E	-250 to 200	1.3	2.0	0.6	0.9
	-200 to -100	0.5	0.8	0.3	0.4
	-100 to 600	0.3	0.4	0.3	0.4
	600 to 1000	0.4	0.6	0.2	0.3
N	-200 to -100	1.0	1.5	0.6	0.9
	-100 to 900	0.5	0.8	0.5	0.8
	900 to 1300	0.6	0.9	0.3	0.4
J	-210 to -100	0.6	0.9	0.3	0.4
	-100 to 800	0.3	0.4	0.2	0.3
	800 to 1200	0.5	0.8	0.3	0.3
K	-200 to -100	0.7	1.0	0.4	0.6
	-100 to 400	0.3	0.4	0.3	0.4
	400 to 1200	0.5	0.8	0.3	0.4
	1200 to 1372	0.7	1.0	0.3	0.4
T	-250 to -200	1.7	2.5	0.9	1.4
	-200 to 0	0.6	0.9	0.4	0.6
	0 to 400	0.3	0.4	0.3	0.4
B	600 to 800	1.3	2.0	1.0	1.5
	800 to 1000	1.0	1.5	0.8	1.2
	1000 to 1820	0.9	1.3	0.8	1.2
R	-20 to 0	2.3	2.8	1.2	1.8
	0 to 100	1.5	2.2	1.1	1.7
	100 to 1767	1.0	1.5	0.9	1.4

S	-20 to 0	2.3	2.8	1.2	1.8
	0 to 200	1.5	2.1	1.1	1.7
	200 to 1400	0.9	1.4	0.9	1.4
	1400 to 1767	1.1	1.7	1.0	1.5
C	0 to 800	0.6	0.9	0.6	0.9
	800 to 1200	0.8	1.2	0.7	1.0
	1200 to 1800	1.1	1.6	0.9	1.4
	1800 to 2316	2.0	3.0	1.3	2.0
L	-200 to -100	0.6	0.9	0.3	0.4
	-100 to 800	0.3	0.4	0.2	0.3
	800 to 900	0.5	0.8	0.2	0.3
U	-200 to 0	0.6	0.9	0.4	0.6
	0 to 600	0.3	0.4	0.3	0.4
BP	0 to 1000	1.0	1.5	0.4	0.6
	1000 to 2000	1.6	2.4	0.6	0.9
	2000 to 2500	2.0	3.0	0.8	1.2
XK	-200 to 300	0.2	0.3	0.2	0.5
	300 to 800	0.4	0.6	0.3	0.6
G	100 to 300	1.6	2.4	1.2	1.8
	300 to 1500	1.0	1.5	1.0	1.5
	1500 to 2315	2.0	3.0	1.6	2.4
D	0 to 300	1.6	2.4	1.2	1.8
	300 to 1500	1.0	1.5	1.0	1.5
	1500 to 2315	2.0	3.0	1.6	2.4
P	0 to 1000	1.6	2.4	0.6	0.9
	1000 to 1395	2.0	3.0	0.8	1.2
M	-50 to 100	1.0	1.5	0.4	0.6
	100 to 1000	1.6	2.4	0.6	0.9
	1000 to 1410	2.0	3.0	0.8	1.2

Notes:

- Sensor inaccuracies not included.
- Accuracy with external cold junction; for internal junction add 0.2 °C
- Temperature scale: ITS-90
- Compensation: NIST Monograph 175 for B, R, S, E, J, K, N, T. DIN 43710 for L, U. GOST P 8.585-2001 (Russia) for BP and XK. ASTM E988-96 for C. ASTM E1751/E1751M - 09ε1 for G, D, P, M
- Resolution: 0.1 °C
- Temperature Coefficient: 0.05 °C/°C (<18 °C or >28 °C)
0.07 °C/°C for C type >1800 °C and for BP type >2000 °C

General Specifications

Maximum voltage applied between any terminal and earth ground or between any two terminals:	30 V
Operating temperature	-10 °C to 50 °C
Storage temperature	-20 °C to 60 °C
Operating altitude	2,000 meters
Storage altitude	12,000 meters
Relative Humidity (% RH operating without condensation)	Non condensing 90 % (10 °C to 30 °C) 75 % (30 °C to 40 °C) 45 % (40 °C to 50 °C) (Without condensation)
Vibration Requirements	MIL-T-28800E, Class 2
Drop Test Requirements	1 meter
IP Rating	IEC 60529: IP52 (with TC cap)
Electromagnetic Environment	IEC 61326-1, Portable FCC: CFR Title 47, Part 15, Subpart B
Safety	IEC 61010-1, Max 30 V to earth, Pollution Degree 2
Electromagnetic Compatibility	Applies to use in Korea only. Class A Equipment (Industrial Broadcasting & Communication Equipment) This product meets requirements for industrial (Class A) electromagnetic wave equipment and the seller or user should take notice of it. This equipment is intended for use in business environments and is not to be used in homes.
Power Supply	4 AA alkaline batteries/NEDA code: 15A, IEC code: LR6
Size (H x W x L)	52.5 x 84 x 188.5 mm
Weight	515 g

Maintenance

Replace the Batteries

⚠️⚠️ Warning

To prevent false readings, which could lead to possible electric shock or personal injury, replace the batteries as soon as the low battery indicator appears.

Figure 1 shows how to replace the batteries.

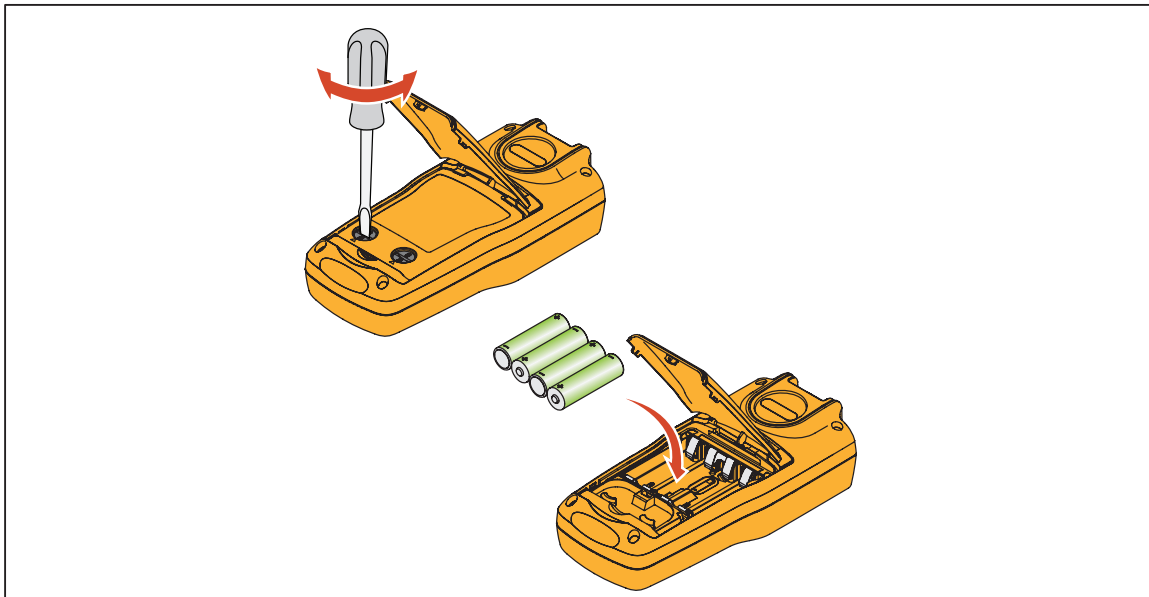

Figure 1. Replace the Batteries

hnh38.eps

Clean the Product

⚠️ Warning

To prevent personal injury or damage to the Product, use only the specified replacement parts and do not allow water into the case.

⚠️ Caution

To avoid damaging the plastic lens and case, do not use solvents or abrasive cleansers.

Clean the Product with a soft cloth dampened with water or water and mild soap.

Required Equipment

The equipment listed in Table 2 is necessary to do the calibration and test for the 712B. The equipment listed in Table 3 is necessary to do the calibration and test for the 714B.

Note

Fluke 5522A and Fluke 8508A need an 8-hour warmup period before the calibration starts. The 5522A needs to zero all the functions weekly and zero Ohms output function every day. The 8508A needs to zero the dc V measurement function, the 4-Wire Ohms measurement function and the DCI measurement function.

Table 2. Required Equipment for 712B Verification and Calibration Adjustment

Item	Equipment	QTY	Comment
①	Fluke 5522A	1	—
②	Fluke 8508A	1	Can be replaced with other reference or equivalent DMMs
③	B-36-2,BANANA PLUG PATCH CORD (Part number:1894785, RED, Part number: 1894724, BLACK) Or Fluke-75X-8014, STACKABLE LEAD SET (Part number: 3669716)	2 sets	Used for all the function calibration and verification test

Table 3. Required Equipment for 714B Verification and Calibration Adjustment

Item	Equipment	QTY	Comment
①	Fluke 5522A	1	The mV output should be calibrated by 8508A ^[1] .
②	Fluke 8508A	1	Can be replaced with other reference or equivalent DMMs ^[2] .
③	Fluke 9101-256	1	Can be replaced with a lag bath and standard sensors ^[3]
④	Pure copper cables with the mini plug	1	Used for the calibration of the mV input function and mV source function
⑤	J TYPE and K TYPE TC Sensor ^[4]	1	Used for verification and calibration adjustment of the temperature function
⑥	Fluke-75X-8014	1	Fluke Item No: 3669716
⑦	Fluke 7526A	1	-
[1]	Before using the mV output function of 5522A, record the 5522A output setting by the reading of the 8508A.		
[2]	The absolute uncertainties of the DMM's dc voltage need to be better than 10 ppm+0.2 μ V in the range of 0 mV and 100 mV.		
[3]	The accuracy (MAX) of standard sensors should be better than 0.05 °C.		
[4]	The accuracy (MAX) of the TC sensor should be better than 0.05 °C.		

712B Performance Verification

Verify that the 712B performance is within the 1 or 2 year specifications as desired.

Turn the 712B on and let it warm up for 5 minutes.

Verify Ohms Source

1. Make connections between the 712B and the 8508A, as shown in Figure 2.

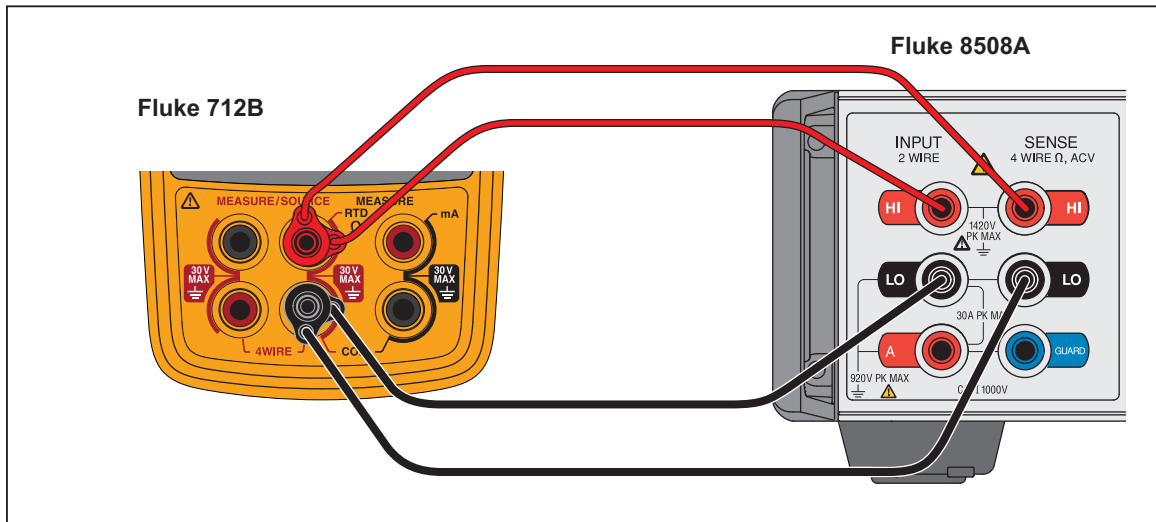

Figure 2. Verify 712B Ohms Source

hwp011.eps

2. Set the 8508A to 4-wire ohms measurement mode. Set the resolution of Ohms measurement mode to 7 1/2-digits or above. Set the range of Ohms measurement mode as shown in Table 4.
3. Set the 712B to Ohms Source mode.
 - a. Push **RTD TYPE**.
 - b. Push **↔** until Ohms is highlighted.
 - c. Push **RTD TYPE** again.
 - d. Push **MEASURE SOURCE** as necessary to enter Source mode.
4. Set the 712B to output the resistance values at the first column in Table 4.
5. Wait approximately 10 seconds until the 8508A shows a stable reading, and verify that the 8508A readings are within the appropriate limits in Table 4.

Note

The 8508A must be set to 4-Wire measurement and in the requested range to maintain currents that are within 712B's limits.

6. Disconnect the 712B from the 8508A.

Table 4. 712B Ohms Source Limits

Source (Ω)	1 Yr. Lower Limit (Ω)	1 Yr. Upper Limit (Ω)	2 Yr. Lower Limit (Ω)	2 Yr. Upper Limit (Ω)	8508A Range
1	0.950	1.050	0.920	1.080	2k range, 4W
10	9.949	10.052	9.917	10.083	2k range, 4W
100	99.935	100.065	99.890	100.110	2k range, 4W
390	389.892	390.109	389.803	390.197	2k range, 4W
1000	999.35	1000.65	998.90	1001.10	20k range, 4W
4000	3998.90	4001.10	3998.00	4002.00	20k range, 4W

Verify 4-Wire Ohms Measure

1. Push **MEASURE SOURCE** to set the 712B to Ohms Measure mode.
2. Push **2 3 4 WIRE** until 4W shows on the screen.
3. Make the connections between the 712B and the 5522A, as shown in Figure 3.
4. Set the 5522A to output the Ohms value at the second column in Table 5.
5. Wait approximately 10 seconds for a stable output of the 5522A, and verify that the 712B readings are within the limits shown.

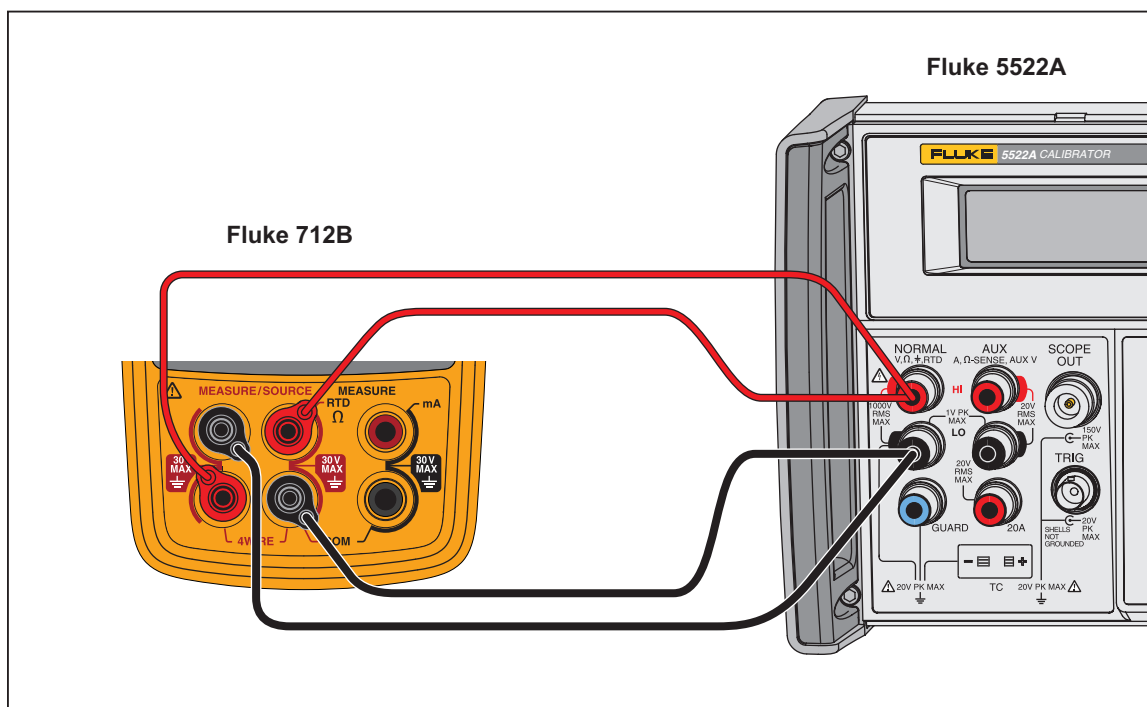

Figure 3. Verify 712B 4-Wire Ohms Measure

hwp003.eps

Table 5. 712B 4-Wire Ohms Measure Limits

Range (Ω)	Applied Ω from 5522A (Ω)	1 Yr. Lower Limit (Ω)	1 Yr. Upper Limit (Ω)	2 Yr. Lower Limit (Ω)	2 Yr. Upper Limit (Ω)
400	1	0.95	1.05	0.92	1.08
400	10	9.95	10.05	9.92	10.08
400	100	99.94	100.06	99.89	100.11
400	390	389.89	390.11	389.80	390.20
4000	1000	999.4	1000.6	998.9	1001.1
4000	4000	3998.9	4001.1	3998.0	4002.0

Verify 3-Wire Ohms Measure

1. Push **MEASURE SOURCE** to set the 712B to Ohms Measure mode.
2. Push **2 3 4 WIRE** until 3W shows on the screen.
3. Make the connections between the 712B and the 5522A, as shown in Figure 4.
4. Set the 5522A to output the Ohms value at the second column in Table 6.
5. Wait approximately 10 seconds for a stable output of the 5522A, and verify that the 712B readings are within the limits shown.

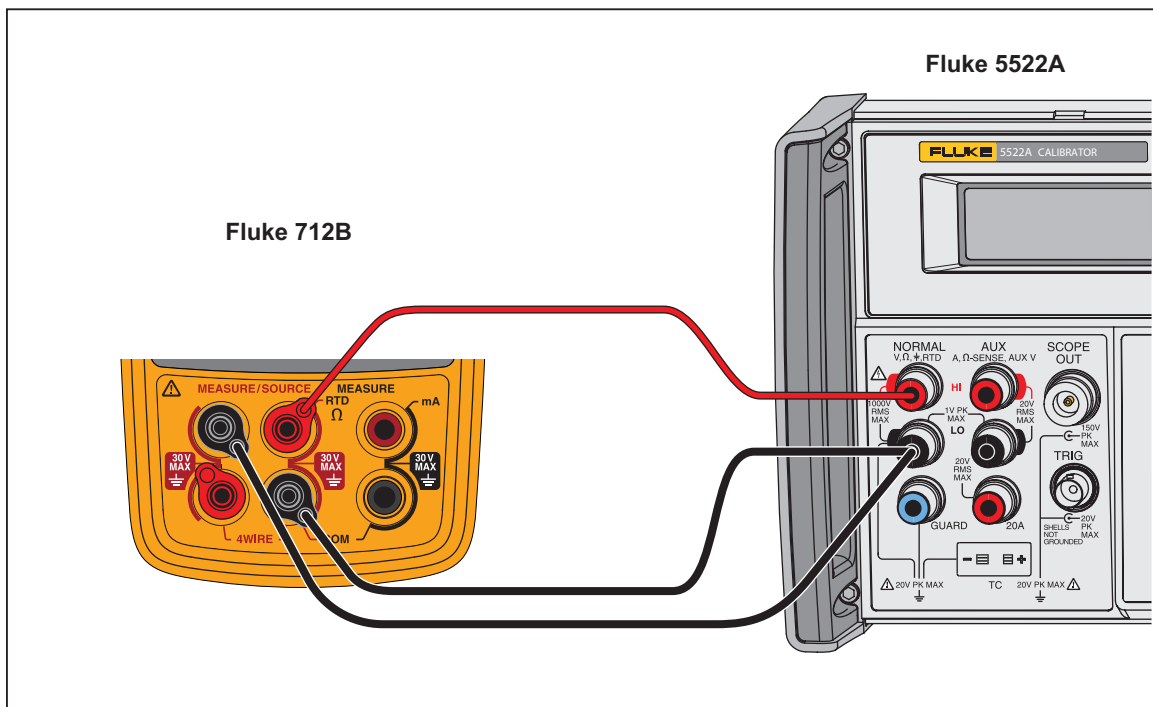

Figure 4. Verify 712B 3-Wire Ohms Measure

hwp018.eps

Table 6. 712B 3-Wire Ohms Measure Limits

Range (Ω)	Applied Ω from 5522A (Ω)	1 Yr. Lower Limit (Ω)	1 Yr Upper Limit (Ω)	2 Yr. Lower Limit (Ω)	2 Yr Upper Limit (Ω)
400	1	0.90	1.10	0.87	1.13
400	100	99.89	100.11	99.84	100.16
4000	1000	999.2	1000.8	998.7	1001.3

Verify mA Measure

1. Make the connections between the 712B, 8508A, and 5522A, as shown in Figure 5.
2. Set the 8508A to DCI measurement mode, set the range of the DCI measurement mode to 20 mA and the resolution of DCI measurement mode to 7 1/2-digits.
3. Adjust the mA source output of 5522A and make that 8508A shows as the first column in the Table 7, and verify that the 712B readings are within the limits shown.

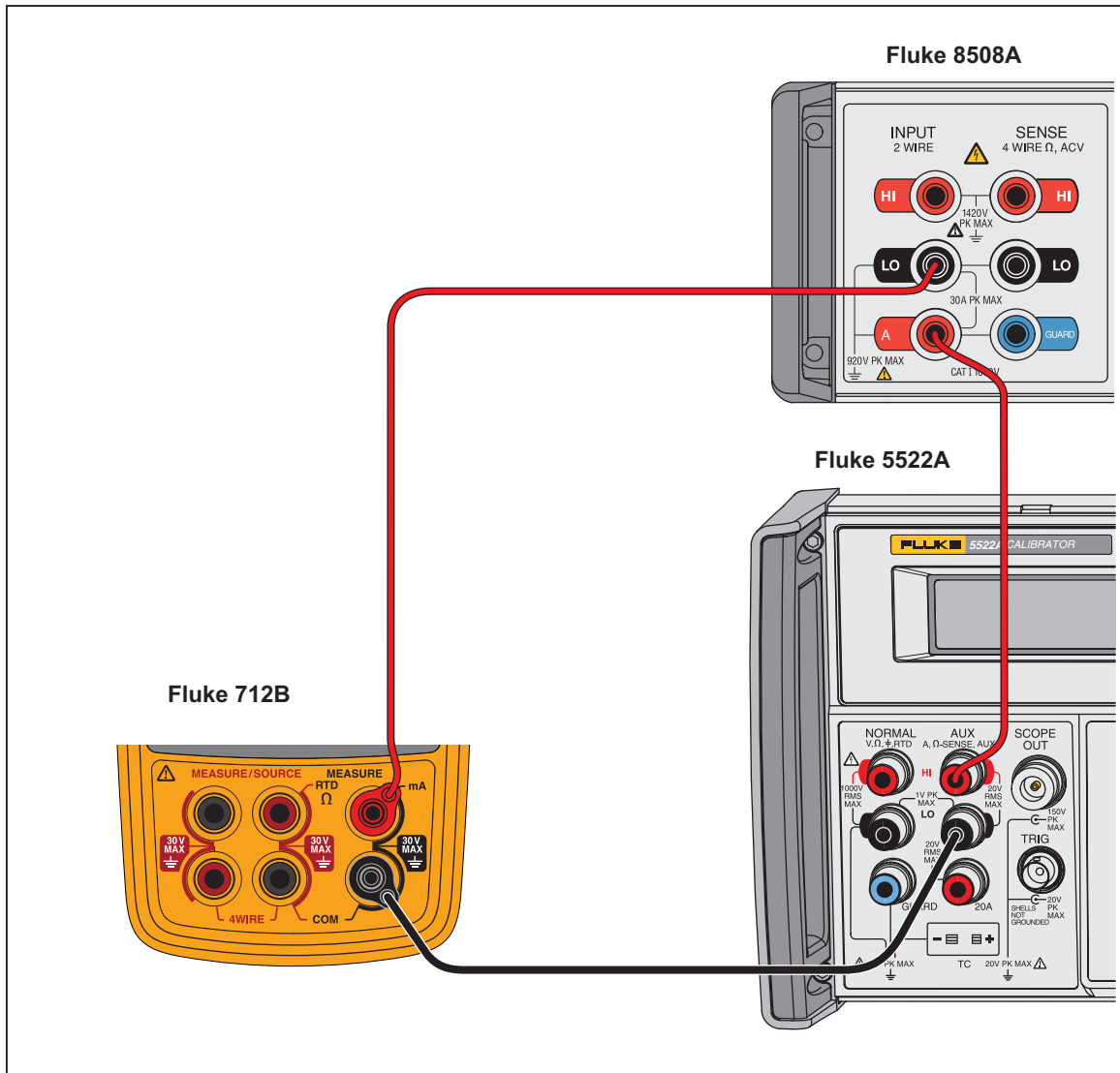

hwp004.eps

Figure 5. Verify 712B mA Measure

Table 7. 712B mA Measure Limits

DC Current Display from 8508A (mA)	1 Yr. Lower Limit (mA)	1 Yr Upper Limit (mA)	2 Yr. Lower Limit (mA)	2 Yr Upper Limit (mA)
0.100	0.098	0.102	0.096	0.104
19.000	18.996	19.004	18.992	19.008

714B Performance Verification

Verify that the 714B performance is within the 1 or 2 year specifications as desired.

Turn the 714B on and let it warm up for 5 minutes.

Verify mV Source

1. Make connections between the 714B and the 8508A with copper wire, as shown in Figure 6.

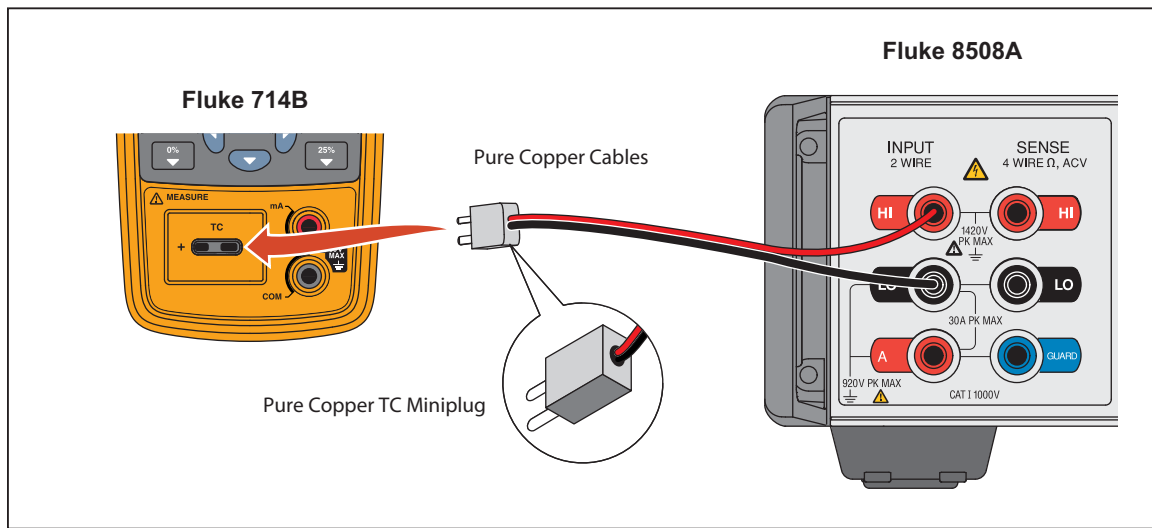

Figure 6. Verify 714B mV Source

hwp006.eps

2. Set the 714B to Source mV mode.
 - a. Push **TC TYPE**.
 - b. Push **↔** until mV is highlighted.
 - c. Push **TC TYPE** again.
 - d. Push **MEASURE SOURCE** as necessary to enter Source mode.
3. Set the 714B to output the mV values in Table 8.
4. Check that the 8508A readings are within the appropriate limits in Table 8.

Table 8. 714B mV Source Limits

Range (mV)	Sourced (mV)	1 Yr. Lower Limit (mV)	1 Yr Upper Limit (mV)	2 Yr. Lower Limit (mV)	2 Yr Upper Limit (mV)
-10 to 75	-9.5	-9.511	-9.489	-9.517	-9.483
-10 to 75	10	9.989	10.012	9.983	10.017
-10 to 75	40	39.984	40.016	39.977	40.023
-10 to 75	70	69.980	70.020	69.971	70.029

Verify mV Measure

1. Make connections between the 714B and the 5522A with copper wire, as shown in Figure 7.

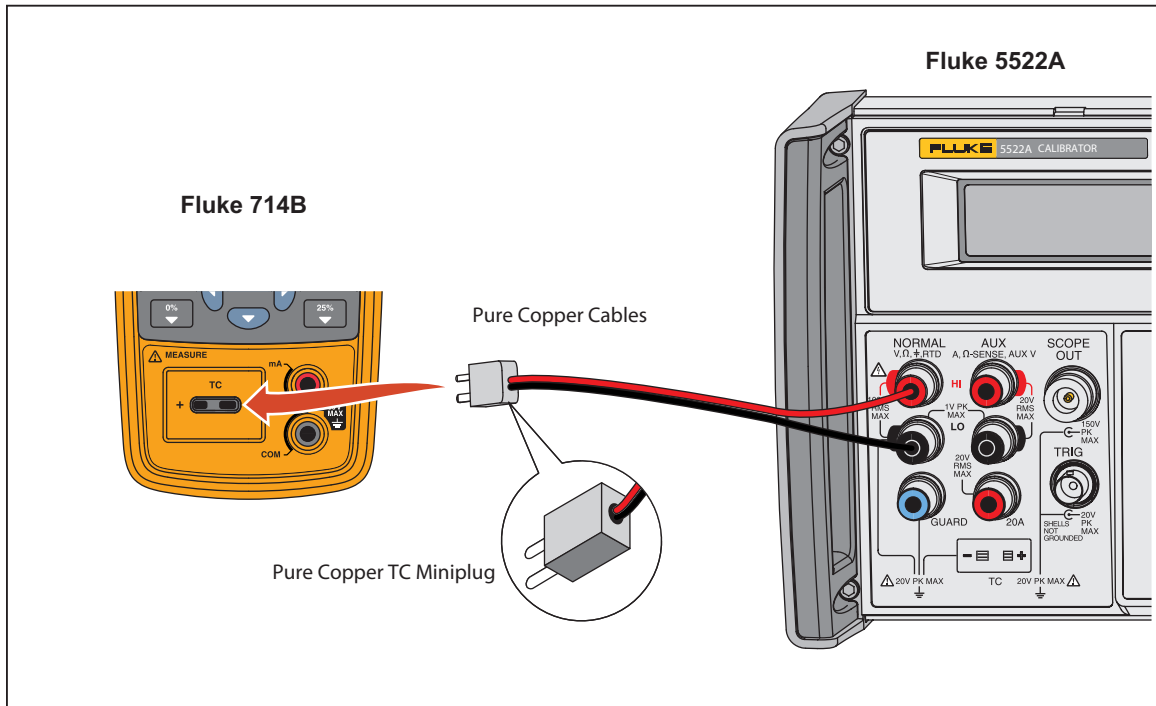

Figure 7. Verify 714B mV Measure

hwp007.eps

2. Push **MEASURE** to set the 714B to mV Measure mode.
3. Set the 5522A to the first value in Table 9.
4. Output the mV values in Table 9 and verify that the 714B readings are within the limits shown.

Table 9. 714B mV Measure Limits

Sourced (mV)	1 Yr. Lower Limit (mV)	1 Yr Upper Limit (mV)	2 Yr. Lower Limit (mV)	2 Yr Upper Limit (mV)
-9.5	-9.511	-9.489	-9.517	-9.483
10	9.989	10.012	9.983	10.017
40	39.984	40.016	39.977	40.023
70	69.980	70.020	69.971	70.029

Verify TC Measure (Type K)

1. Set the 714B to Type K Measure mode.
2. Set the 7526A to TC Out Type K.
3. Use K type TC sensor to connect the 7526A and the 714B, as shown in Figure 8.

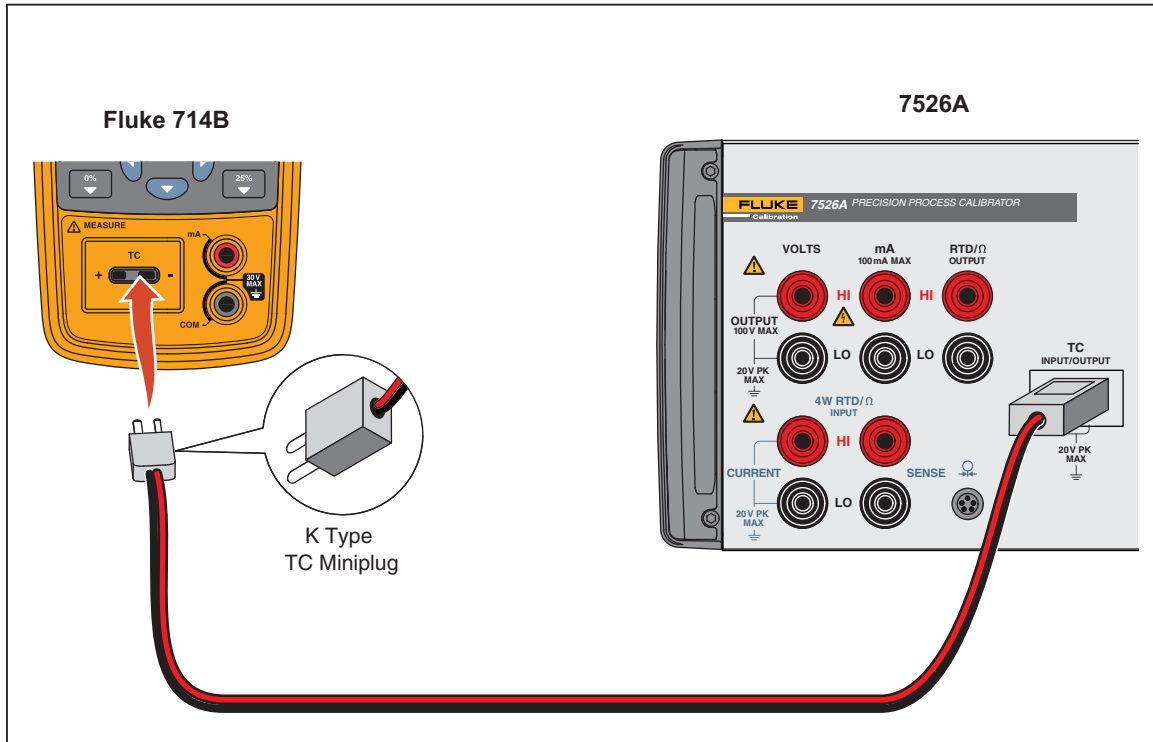

Figure 8. Verify Type K Measure

hwp015.eps

4. Set the 7526A to the values in Table 10 and verify that the 714B readings are within the limits shown.

Table 10. 714B Type K Measure Limits

5522A Sourced (°C)	1 Yr. Lower Limit (°C)	1 Yr Upper Limit (°C)	2 Yr. Lower Limit (°C)	2 Yr Upper Limit (°C)
-180	-180.9	-179.1	-181.2	-178.8
0	-0.5	0.5	-0.6	0.6
1300	1299.1	1300.9	1298.8	1301.2

Verify TC K Source

1. Set the 714B to type K Source mode.
2. Set the 7526A to TC IN Type K
3. Maintain the connections in Figure 8.
4. Set the 714B to the values in Table 11 and verify that the 7526A readings are within the limits shown.

Table 11. 714B TC K Source Limits

714B Sourced (°C)	1 Yr. Lower Limit (°C)	1 Yr Upper Limit (°C)	2 Yr. Lower Limit (°C)	2 Yr Upper Limit (°C)
-100	-100.5	-99.5	-100.6	-99.4
0	-0.5	0.5	-0.6	0.6
800	799.5	800.5	799.4	800.6

Verify mA Measure

1. Connect the 5522A, 8508A, and 714B, as shown in Figure 9.
2. Set the 8508A to DCI measurement mode, set the range of the DCI measurement mode to 20 mA and the resolution of DCI measurement mode to 7 1/2-digits.
3. Set the 5522A to source and make sure that 8508A shows the first dc current in Table 12.
4. Output the dc current values in Table 12 and verify that the 714B readings are within the limits shown.

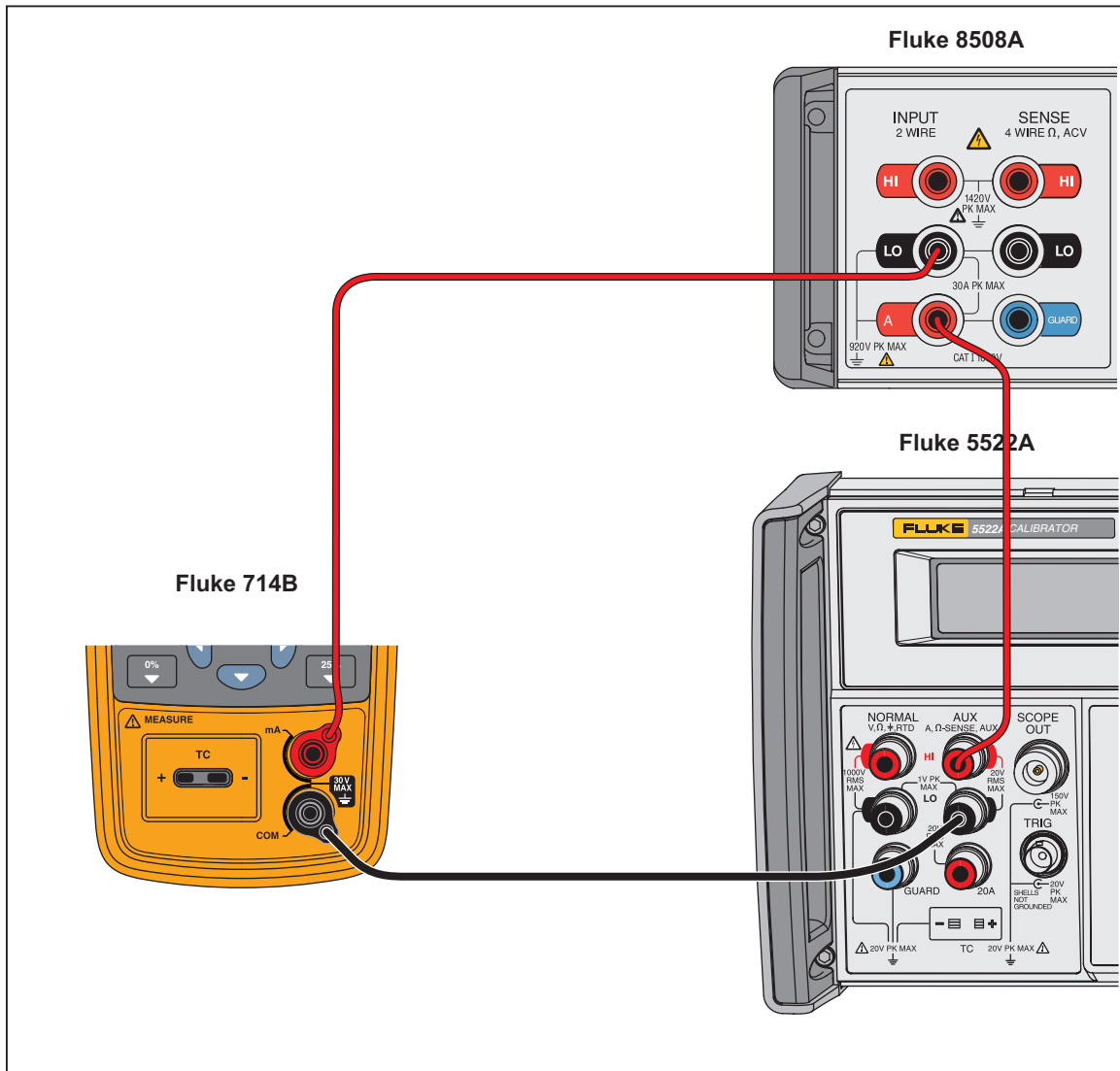

Figure 9. Verify mA Measure

hwp010.eps

Table 12. 714B mA Measure Limits





DC current display from 8508A (mA)	1 Yr. Limit (mA)	2 Yr. Limit (mA)
0.100	0.098 – 0.102	0.096 – 0.104
19.000	18.996 – 19.004	18.992 – 19.008

712B Calibration Adjustment

This section describes how to adjust for the 712B.

Enter Manual Calibration Mode

To enter manual calibration mode:

1. Power off the Product.
2. Push and hold down  and  at the same time.
3. Push and then release .
4. Release  and .

The Welcome screen shows.

5. After a warmup period of approximately 5 minutes, start the calibration adjustment.

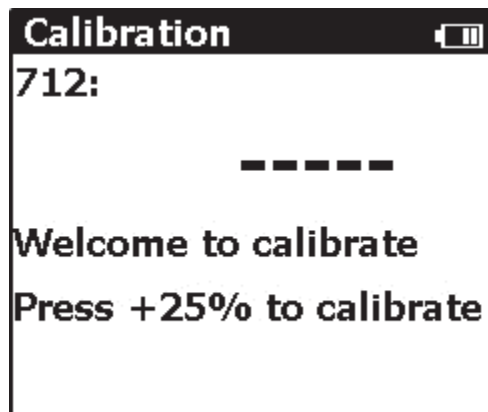

hwp01.jpg

Adjust Ohms Source

Before the calibration adjustment, set the 8508A to 4-Wire Ohms measurement mode, set the resolution of Ohms measurement mode to 7 1/2-digits or above, and use two sets of banana plug patch cords to connect the 712B and the 8508A, as shown in Figure 10.

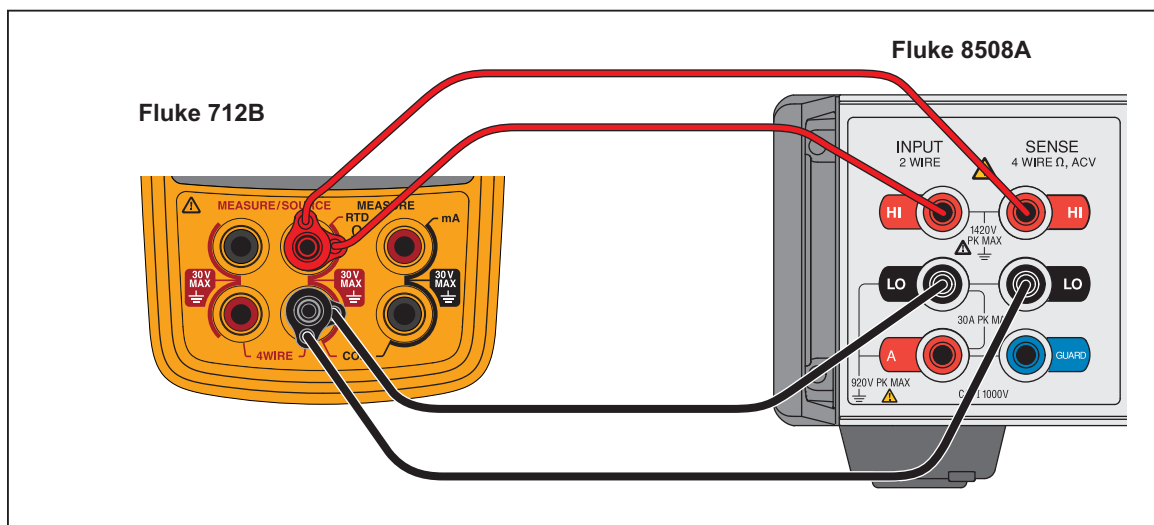

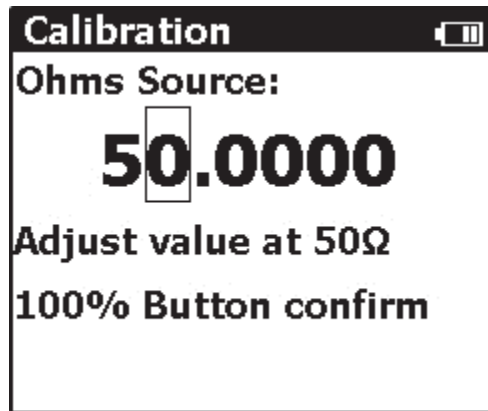

Figure 10. Adjust 712B Ohms Source

hwp011.eps

Adjust 50 Ω Source

1. Set the range of 8508A 4-Wire measurement to 2 k Ω .
2. Push  on the 712B to enter the 50 Ω Source calibration mode.
3. Wait approximately 10 seconds until the 8508A shows a stable reading.
4. Use the arrow keys to input the reading into the 712B.
5. Confirm the input.



hwp02.jpg

Adjust 350 Ω Source

1. Push  to enter 350 Ω Source calibration mode.
2. Wait approximately 10 seconds until the 8508A shows a stable reading.
3. Input the reading into the 712B.
4. Confirm the input.

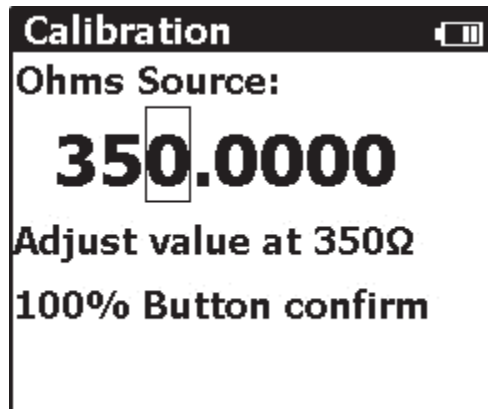

hwp03.jpg

Adjust 500 Ω Source

1. Set the range of 8508A 4-Wire measurement to 20 k Ω .
2. Push  to enter 500 Ω Source calibration mode.
3. Wait approximately 10 seconds until the 8508A shows a stable reading.
4. Input the reading into the 712B.
5. Confirm the input.

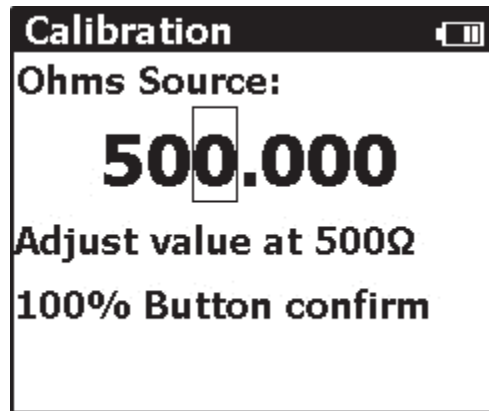

hwp04.jpg

Adjust 3500 Ω Source

1. Push  to enter 500 Ω Source calibration mode.
2. Wait approximately 10 seconds until the 8508A shows a stable reading.
3. Input the reading into the 712B.
4. Confirm the input.

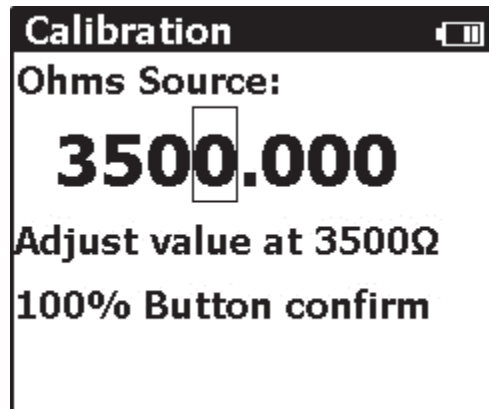

hwp05.jpg

Adjust Trigger Current for Ohms Measure

Before the calibration adjustment, set the 8508A to DCI measurement mode, set the resolution of DCI measurement mode to 7 1/2-digits, and use one set of banana plug patch cords to connect the 712B and the 8508A, as shown in Figure 11.

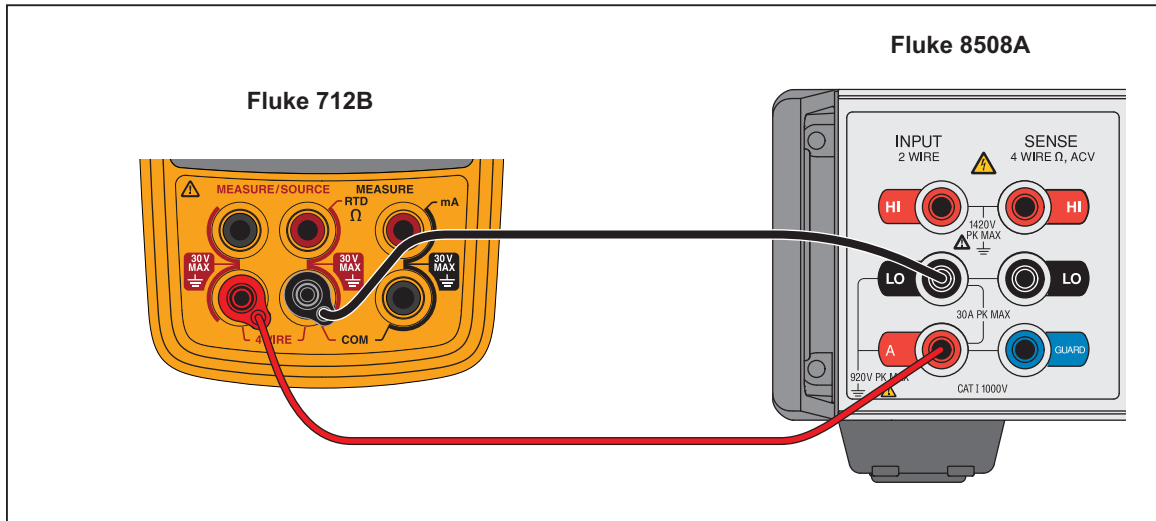

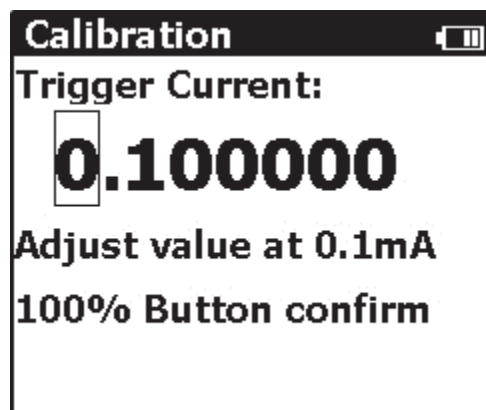

Figure 11. Adjust 712B Trigger Current

hwp002.eps

Adjust 0.1 mA Trigger Current

1. Set the range of the 8508A dc mA measurement to 2 mA.
2. Push  on the 712B to enter 0.1 mA trigger current calibration mode.
3. Wait approximately 15 seconds until the 8508A shows a stable reading.
4. Input the reading into the 712B.
5. Confirm the input.



hwp06.jpg

Adjust 0.25 mA Trigger Current

1. Push  on the 712B to enter 0.25 mA trigger current calibration mode.
2. Wait approximately 15 seconds until the 8508A shows a stable reading.
3. Input the reading into the 712B.
4. Confirm the input.

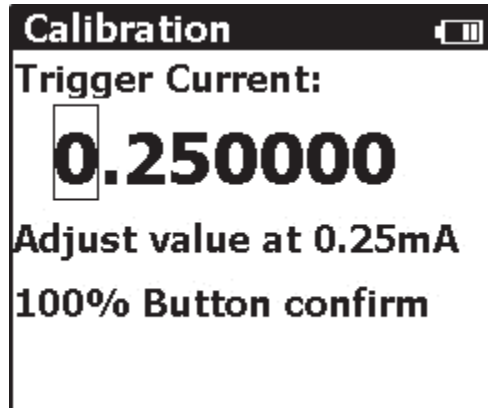

hwp07.jpg

Adjust 0.5 mA Trigger Current

1. Push  on the 712B to enter 0.5 mA trigger current calibration mode.
2. Wait approximately 15 seconds until the 8508A shows a stable reading.
3. Input the reading into the 712B.
4. Confirm the input.

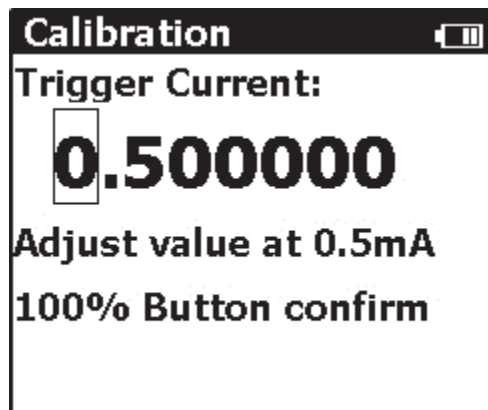

hwp08.jpg

Adjust 1 mA Trigger Current

1. Push  on the 712B to enter 1 mA trigger current calibration mode.
2. Wait approximately 15 seconds until the 8508A shows a stable reading.
3. Input the reading into the 712B.
4. Confirm the input.

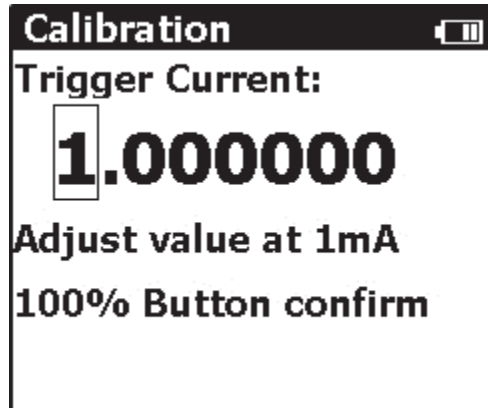

hwp09.jpg

Adjust Ohms Measure

Before the calibration adjustment, set the 5522A to Ohms source output mode, and use two sets of banana plug patch cords to connect the 712B and the 5522A, as shown in Figure 12.

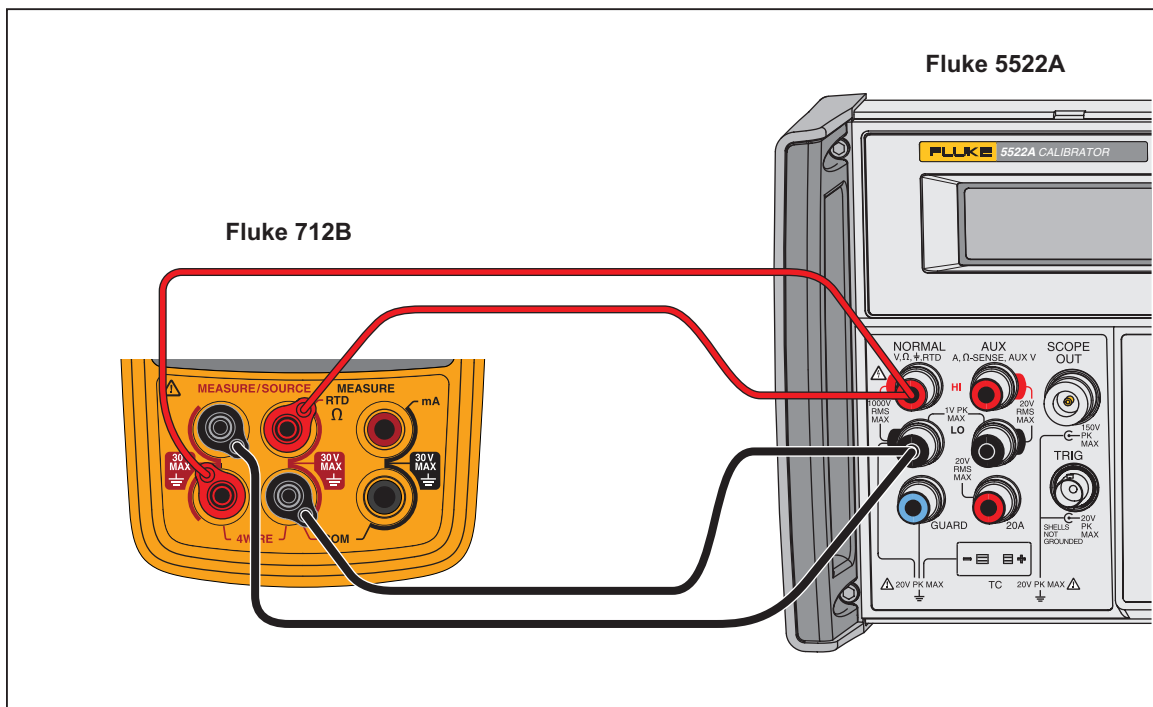
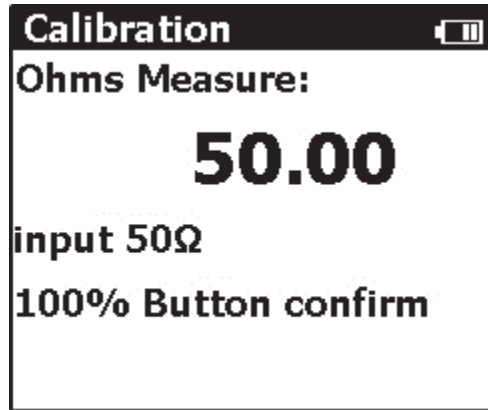

Figure 12. Adjust 712B Ohms Measure

hwp003.eps

Adjust 50 Ω Input

1. Set the 5522A to output 50 Ω .
2. Wait approximately 10 seconds for a stable output of the 5522A.
3. Confirm the reading on the 712B.



hwp10.jpg

Adjust 350 Ω Input

1. Push  on the 712B to enter 350 Ω input calibration mode.
2. Set the 5522A to output 350 Ω .
Wait approximately 10 seconds for a stable output of the 5522A.
3. Confirm the reading on the 712B.

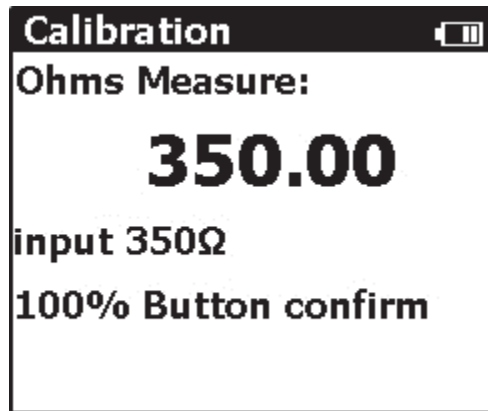

hwp11.jpg

Adjust 500 Ω Input

1. Push  on the 712B to enter 500 Ω input calibration mode.
2. Set the 5522A to output 500 Ω .
Wait approximately 10 seconds for a stable output of the 5522A.
3. Confirm the reading on the 712B.

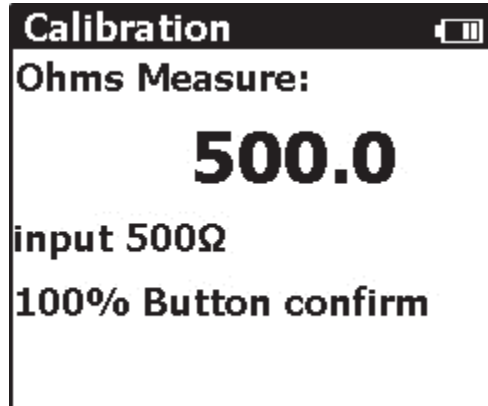

hwp12.jpg

Adjust 3500 Ω Input

1. Push  on the 712B to enter the 3500 Ω input calibration mode.
2. Set the 5522A to output 3500 Ω .
Wait approximately 10 seconds for a stable output of the 5522A.
3. Confirm the reading on the 712B.

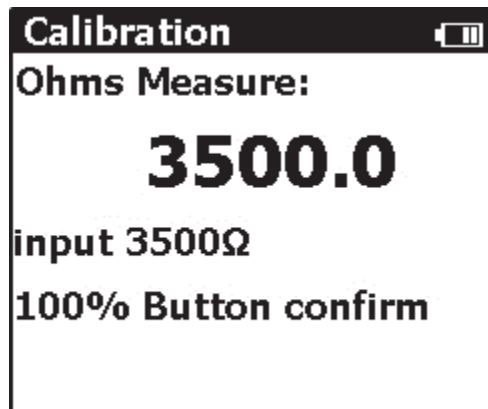

hwp13.jpg

Adjust mA Measure

Before the calibration adjustment, set the 5522A to mA (dc) source output mode, and use one set of banana plug patch cords to connect the 712B and the 5522A, as shown in Figure 13.

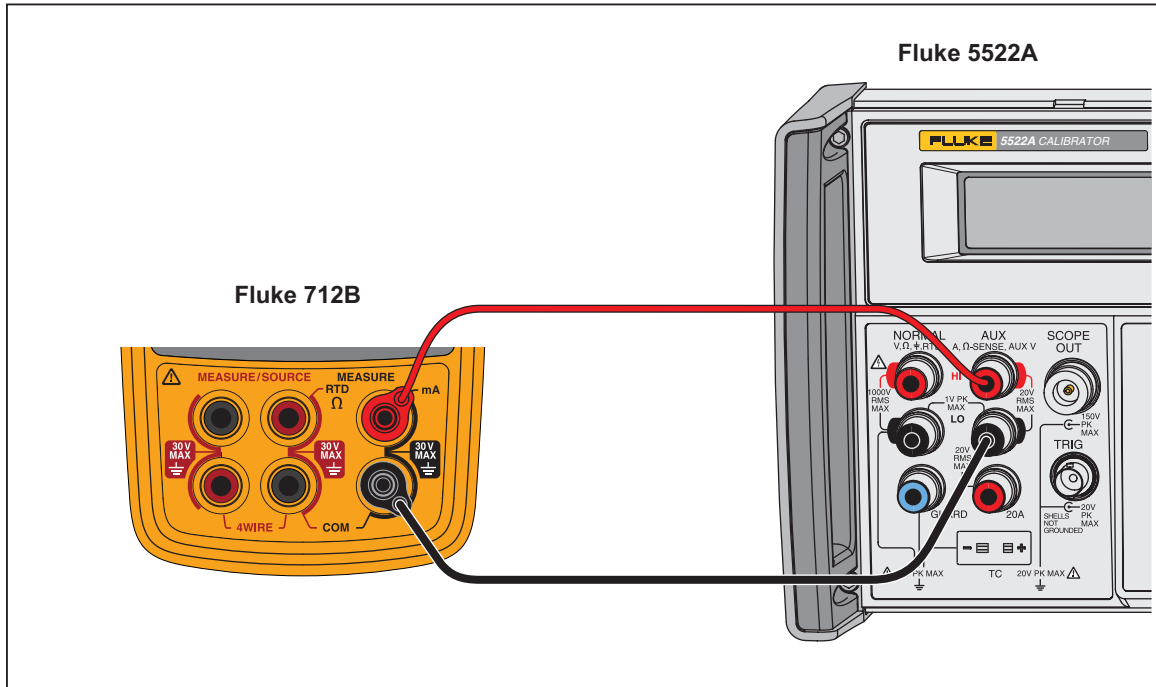

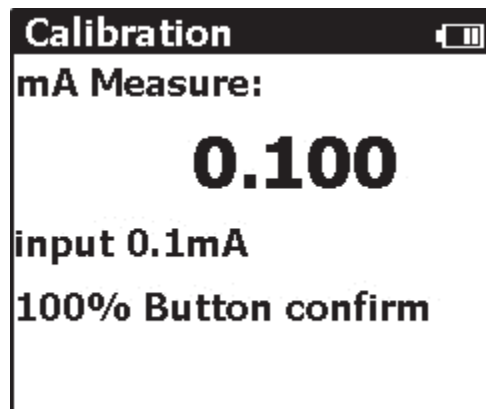

Figure 13. Adjust 712B mA Measure

hwp022.eps

Adjust 0.1 mA Input

1. Set the 5522A to output 0.1 mA.
2. Push  on the 712B to enter 0.1 mA input calibration mode. Wait approximately 10 seconds for a stable output of the 5522A.
3. Confirm the reading on the 712B.



hwp14.jpg

Adjust 24 mA Input

1. Set the 5522A to output 24 mA.
2. Push  on the 712B to enter 24 mA input calibration mode. Wait approximately 10 seconds for a stable output of the 5522A.
3. Confirm the reading on the 712B.

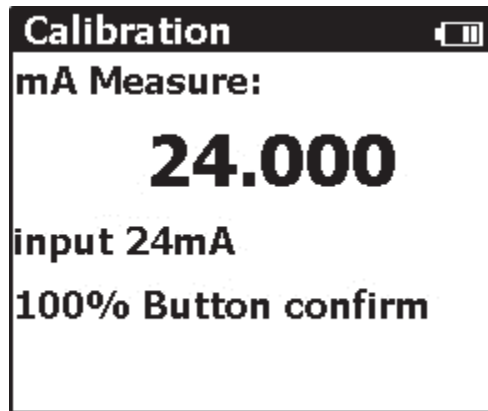

hwp15.jpg

Adjust External Trigger for Ohms Source

Before the calibration, set the 5522A to mA (dc) source output mode, and use one set of banana plug patch cords to connect the 712B and the 5522A, as shown in Figure 14.

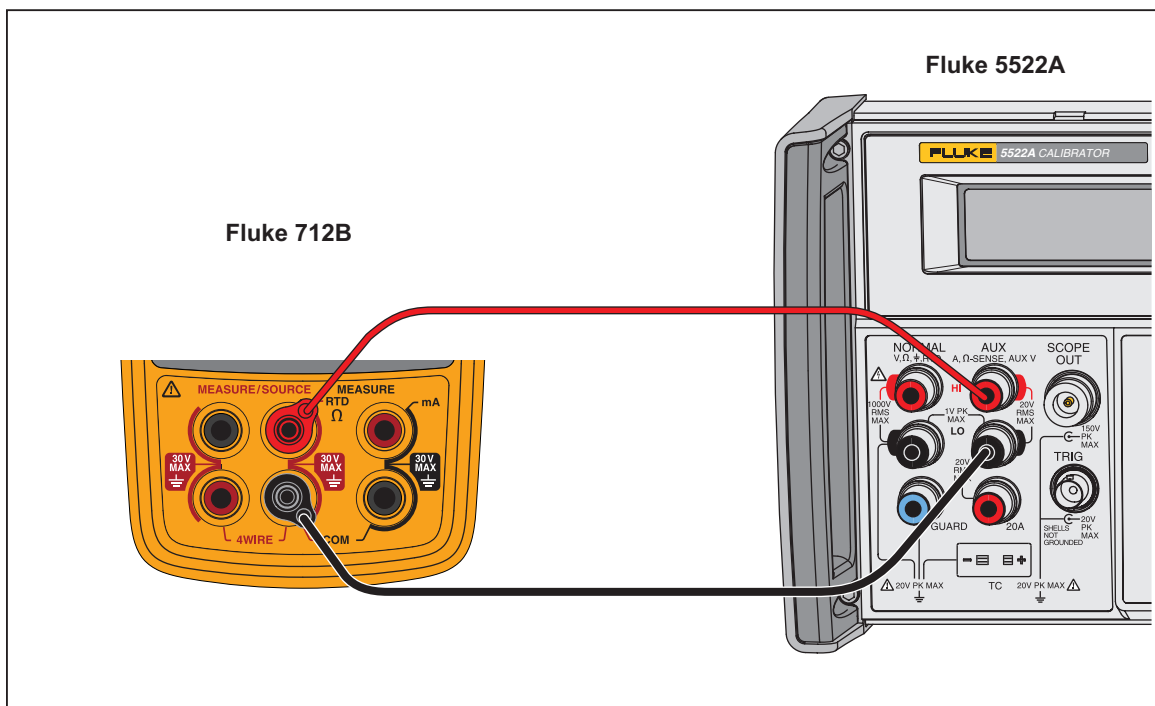

hwp005.eps

Figure 14. Adjust External Trigger for Ohms Source

Adjust 0.1 mA External Trigger

1. Set the 5522A to output 0.1 mA.
2. Push  on the 712B to enter 0.1 mA external trigger calibration mode.
3. Wait approximately 10 seconds for a stable output of the 5522A.
4. Confirm the reading on the 712B.

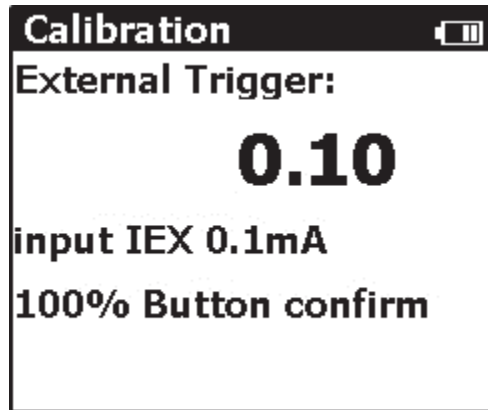

hwp16.jpg

Adjust 1 mA External Trigger

1. Set the 5522A to output 1 mA.
2. Push  on the 712B to enter 1 mA external trigger calibration mode.
3. Wait approximately 10 seconds for a stable output of the 5522A.
4. Confirm the reading on the 712B.

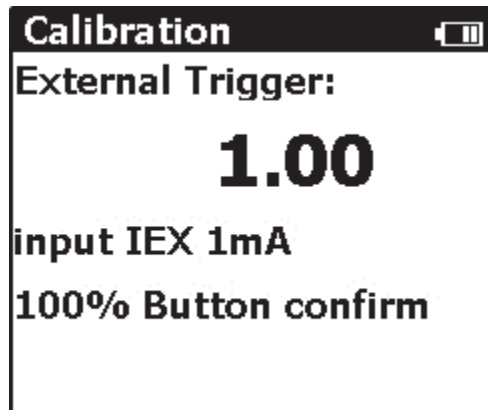

hwp17.jpg

Save Data and Reset the 712B System

After the calibration procedure described above is done, push  to confirm and store the calibration data. The 712B system is automatically reset.

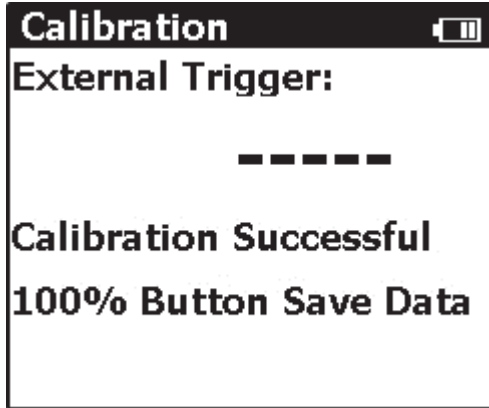

hwp18.jpg

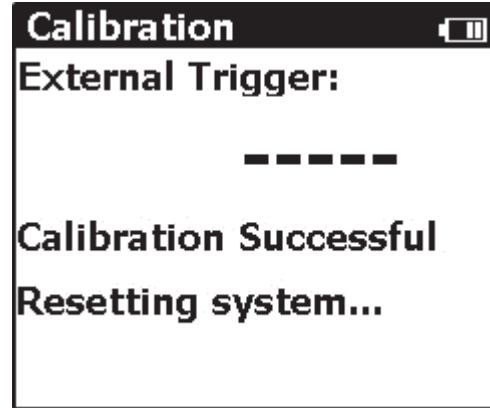





hwp19.jpg

714B Calibration Adjustment

Enter Calibration Mode

To enter manual calibration mode:

1. Power off the Product.
2. Push and hold down  and  at the same time.
3. Push and then release .
4. Release  and .

The Welcome screen shows.

5. After a warmup period of approximately 5 minutes, start the calibration adjustment.

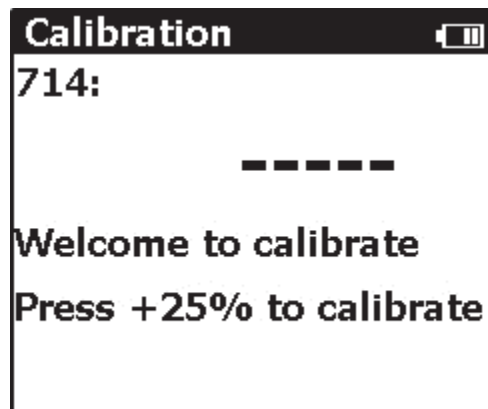

hwp20.jpg

Use 8508A to Adjust the 5522A Output

To use the 8508A to calibrate the 5522A output:

1. Connect the voltage output terminals of the 5522A with the voltage input connectors of the 8508A via the pure copper cables.
2. Set the resolution of DCV measurement mode to 7 1/2-digits or above.
3. Adjust the output of the 5522A until the reading of the 8508A is $-10\text{ mV} \pm 0.2\text{ }\mu\text{V}$, and record the voltage setting of the 5522A (=Voltage_{-10mV} Setting).
4. Adjust the output of the 5522A until the reading of the 8508A is $75\text{ mV} \pm 0.2\text{ }\mu\text{V}$, and record the voltage setting of the 5522A (=Voltage_{75mV} Setting).

Note

The two voltage setting records are used to calibrate the UUT.

Adjust mV Source

To calibrate the 714B mV Source function:

1. Connect the 714B TC mini plug and the 8508A with pure copper cables, as shown in Figure 15.

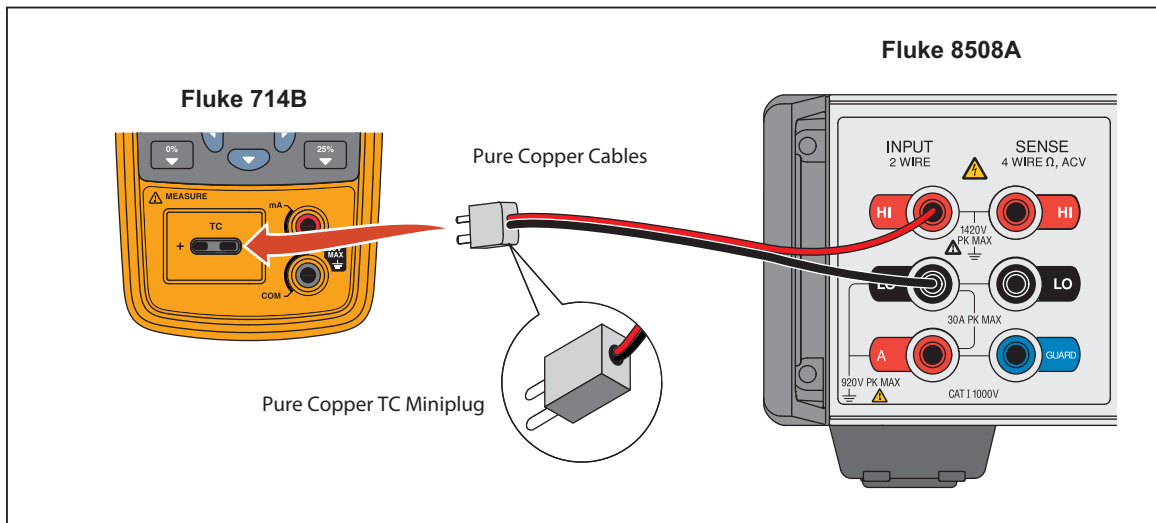
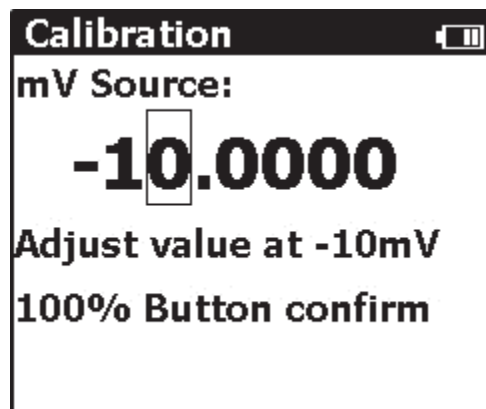



Figure 15. Connect the 714B to the 8508A

hwp006.eps

2. Push **25%** to enter -10 mV Source calibration mode.
3. Input the reading on the 8508A to the 714B.



hwp21.jpg

4. Push  to enter the 75 mV source calibration mode.

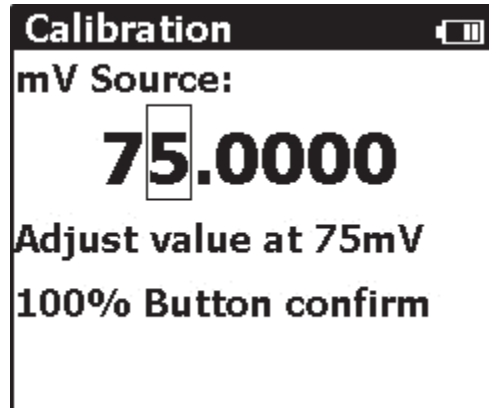

hwp22.jpg

5. Input the new reading on the 8508A to the 714B.
6. Push  to confirm.

Adjust mV Measure

1. Connect the 714B TC mini plug to the 5522A with pure copper cables, as shown in Figure 16.

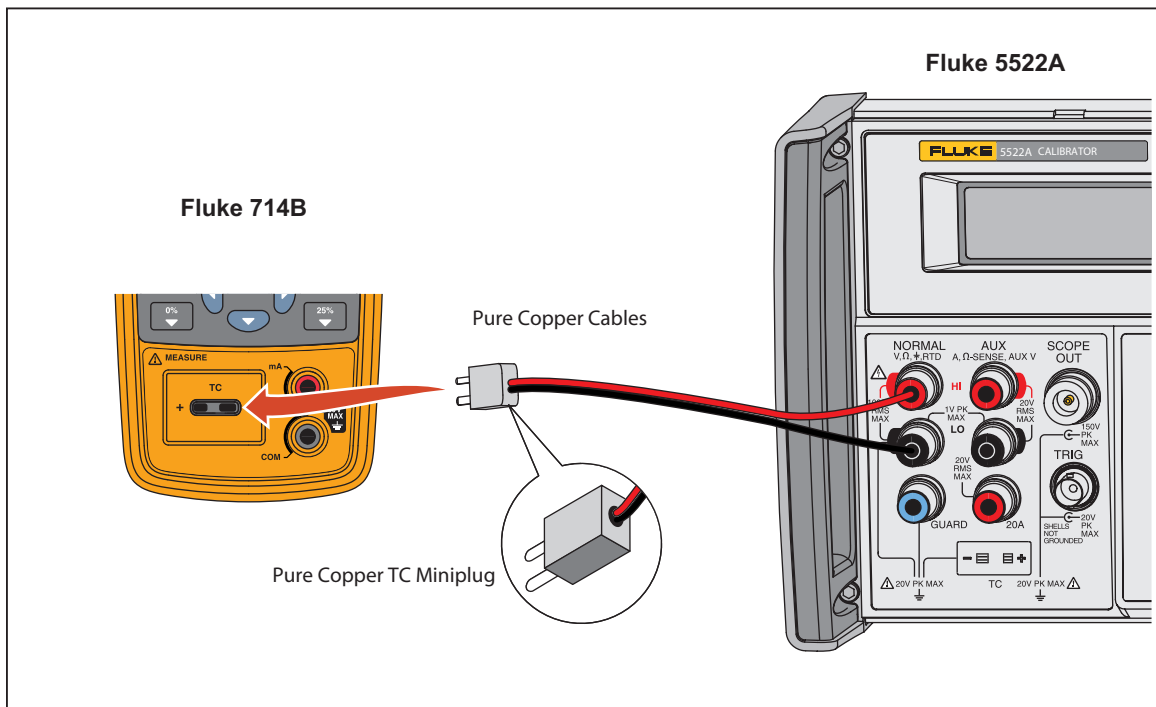

hwp007.eps

Figure 16. Adjust 714B mV Measure

The 5522A outputs the value (*Voltage*-10mV Setting).

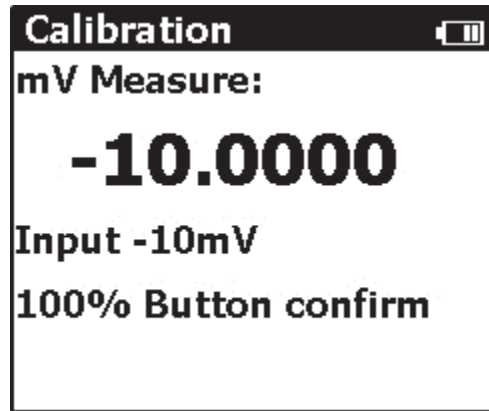

hwp23.jpg

The 5522A outputs the value (*Voltage_{75mV} Setting*).

2. After approximately 10 seconds, push  to calibrate the value.

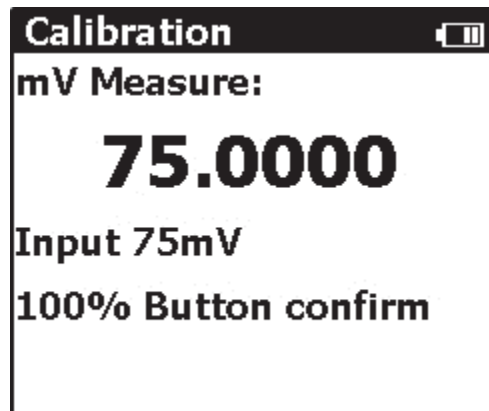

hwp24.jpg

Adjust Internal Cold Junction Temperature

Use the Fluke 9101-256 or a lag bath to calibrate the internal cold junction temperature.

Use the Fluke 9101-256

To use the Fluke 9101-256 to calibrate the internal cold junction temperature:

1. Connect the Fluke 9101-256 and the 714B via the J type thermocouple sensor, as shown in Figure 17.

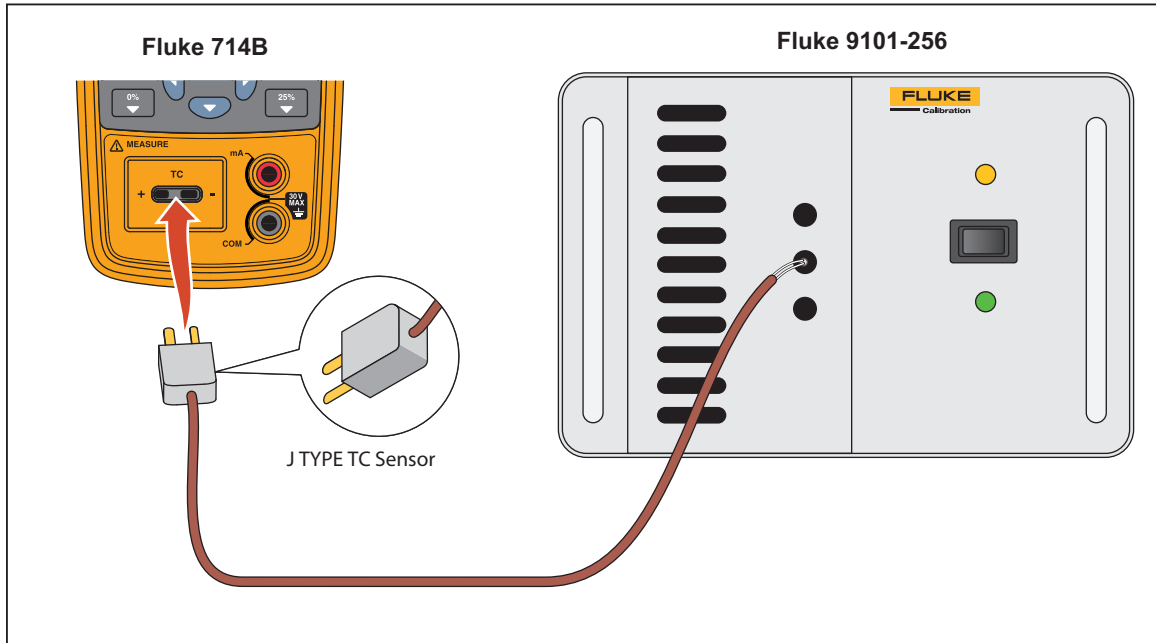
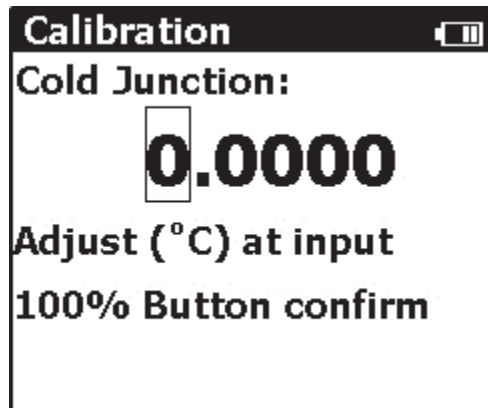



Figure 17. Connect the 714B to the Fluke 9101-256

hwp008.eps

2. After the J type thermocouple is inserted, wait approximately 5 minutes for the temperature reading to stabilize.



hwp25.jpg

3. Push  to calibrate the cold junction temperature.

Use a Lag Bath

To use a lag bath to calibrate the internal cold junction temperature:

1. Connect the lag bath and the 714B via the J type thermocouple sensor, and immerse the thermocouple and a precision mercury thermometer in the mineral oil lag bath, as shown in Figure 18.
2. After the thermocouple is inserted, wait approximately 5 minutes for the temperature reading to stabilize.
3. Record the reading on the standard sensor, and input the reading to the 714B.
4. Push  to calibrate the cold junction temperature.

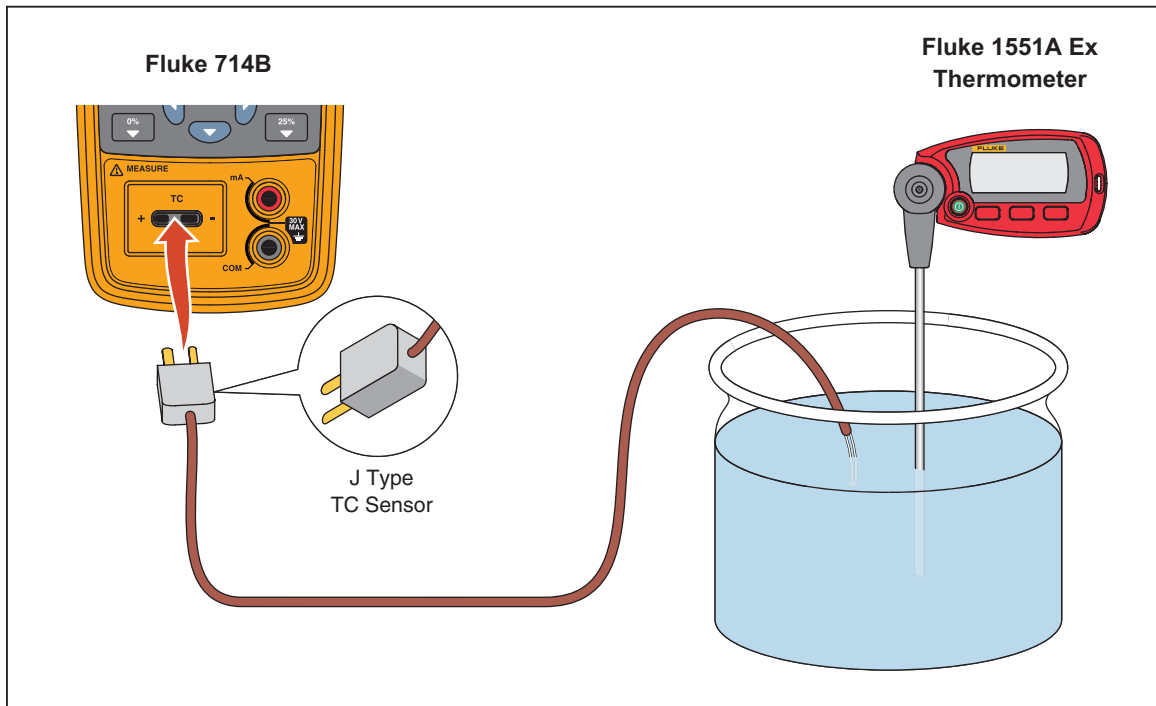

Figure 18. Use Lag Bath to Adjust Cold Junction Temperature

hwp009.eps

Note

The mercury thermometer can be replaced with other standard temperature sensors. The temperature of the lag bath should be within $\pm 2^{\circ}\text{C}$ of ambient temperature.

Adjust mA Measure

1. Connect the 5522A and the 714B via the Fluke-75X-8014 cable, as shown in Figure 19.

The 5522A outputs 0.1 mA.

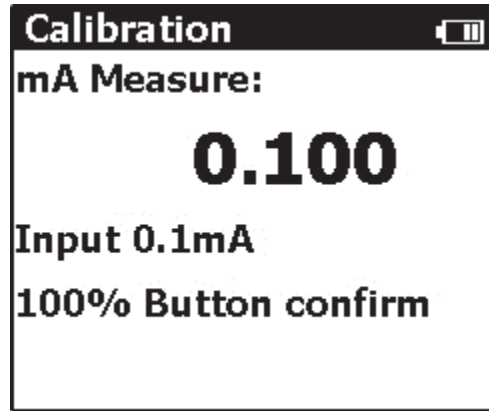

hwp26.jpg

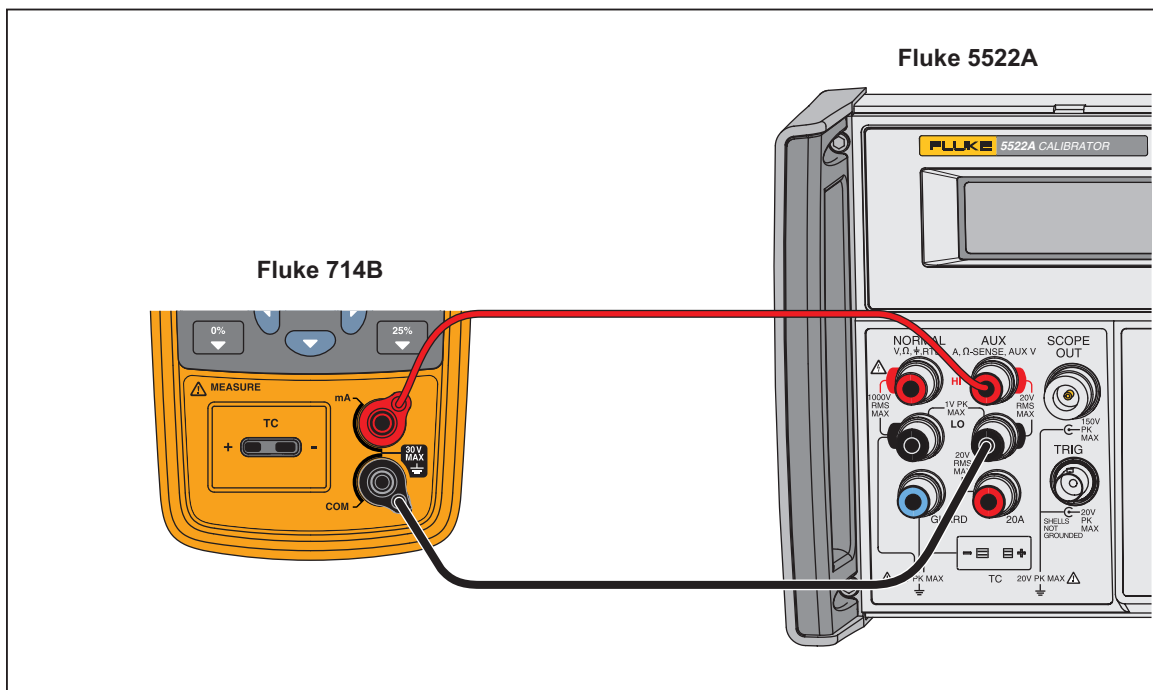

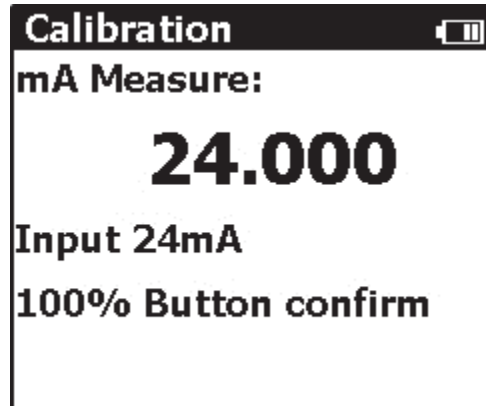

Figure 19.714B and 5522A mA Channel Connections

hwp023.eps

2. Push . The 5522A outputs 24mA.



hwp27.jpg

3. Push  to adjust.

Save Data and Reset the 714B System

After the calibration procedure described above is done, push  to confirm and store the calibration data. The 714B system is automatically reset.

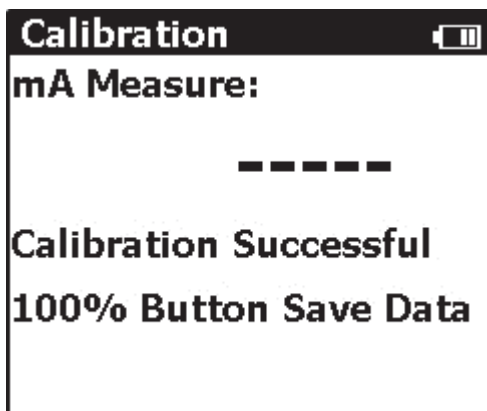

hwp28.jpg

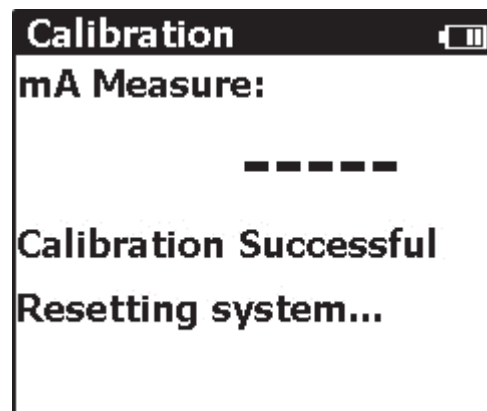

hwp29.jpg

User-Replaceable Parts and Accessories

⚠⚠ Warning

To prevent possible electrical shock, fire, or personal injury, use only specified replacement parts.

User-replaceable parts for the 712B are listed in Table 13 and shown in Figure 20. User-replaceable parts for the 714B are listed in Table 14 and shown in Figure 21. For more information about these items, contact a Fluke representative. See the “Contact Fluke” section of this manual.

Table 13. User-Replaceable Parts and Accessories for 712B

Item	Description	Part Number
①	Case top	4307068
②	Decal	4307164
③	Keypad	4307147
④	Keypad support	4307112
⑤	Screw, M2.2 x 0.8, 5 MM, PAN, PHILLIPS	2032777
⑥	LCD mask	4307101
⑦	LCD protect rubber	4307208
⑧	LCD	4313462
⑨	Support LCD gasket	4307213
⑩	Screw, M3 x 0.5,5MM, PAN, PHILLIPS	2032811
⑪	Case seal rubber	4307186
⑫	Case bottom assembly	4307079
⑬	Screw, M3, 13.5 mm, PAN, PHILLIPS	2388382
⑭	Battery door seal rubber	4307199
⑮	AA battery	376756
⑯	Pad, battery door	4417921
⑰	Battery door assembly	4376901
⑱	Bail stand	4307093
⑲	Quick Reference Guide	4285042
Not Shown	754-8016 alligator clip set	4253535
Not Shown	Stackable test lead set	3669716
Not Shown	Test Leads	variable ^[1]
Not Shown	Alligator Clips	variable ^[1]
<p>[1] See www.fluke.com for more information about the test leads and alligator clips available for your region.</p>		

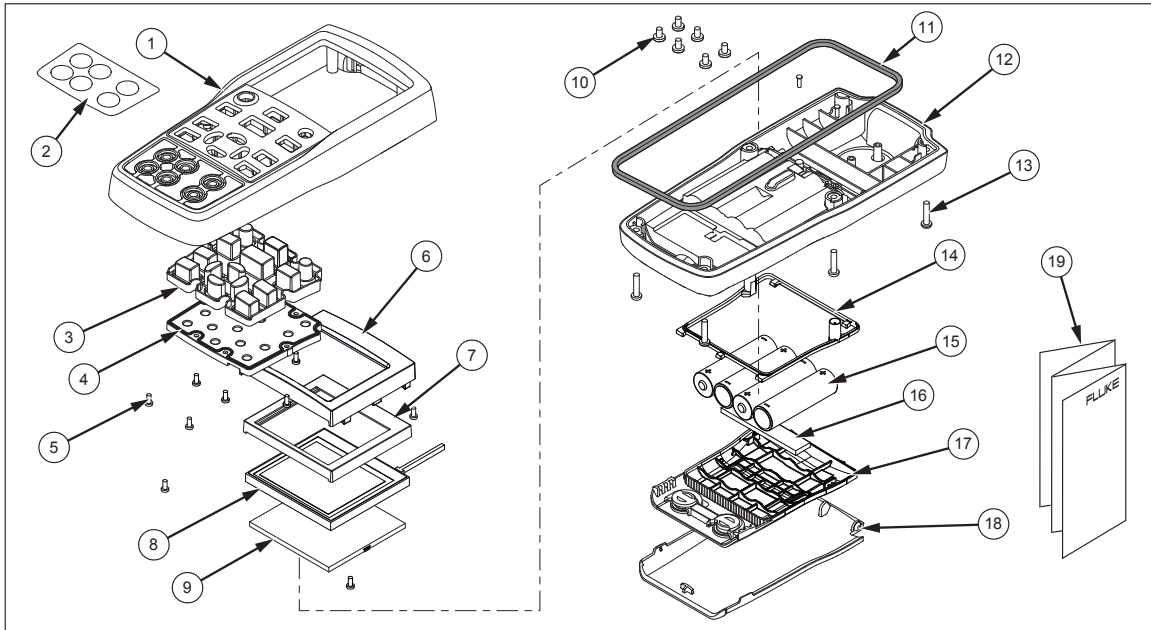

Figure 20. User-Replaceable Parts and Accessories for 712B

hqu46.eps

Table 14. User-Replaceable Parts and Accessories for 714B

Item	Description	Part Number
①	Case top	4307120
②	Decal on case top	4307173
③	TC cap	4369726
④	Keypad	4307158
⑤	Keypad support	4307112
⑥	Screw, M2.2 x 0.8, 5 mm, PAN, Philips	2032777
⑦	TC plate	4307381
⑧	Screw, M3-0.5 x 5 mm, Philips	2032811
⑨	LCD mask	4307135
⑩	LCD protect rubber	4307208
⑪	LCD	4313462
⑫	Support LCD gasket	4307213
⑬	Case seal rubber	4307186
⑭	Case bottom assembly	4307079
⑮	Screw, M3, 13.5 mm, PAN, Philips	2388382
⑯	Battery door seal rubber	4307199
⑰	AA battery	376756
⑱	Pad, battery door	4417921
⑲	Battery door assembly	4376901
⑳	Bail stand	4307093
㉑	Quick Reference Guide	4285039
㉒	TC plugkit, K type	773135
Not Shown	Test Leads, not shown	variable ^[1]
Not Shown	Alligator Clips	
[1] See www.fluke.com for more information about the test leads and alligator clips available for your region.		

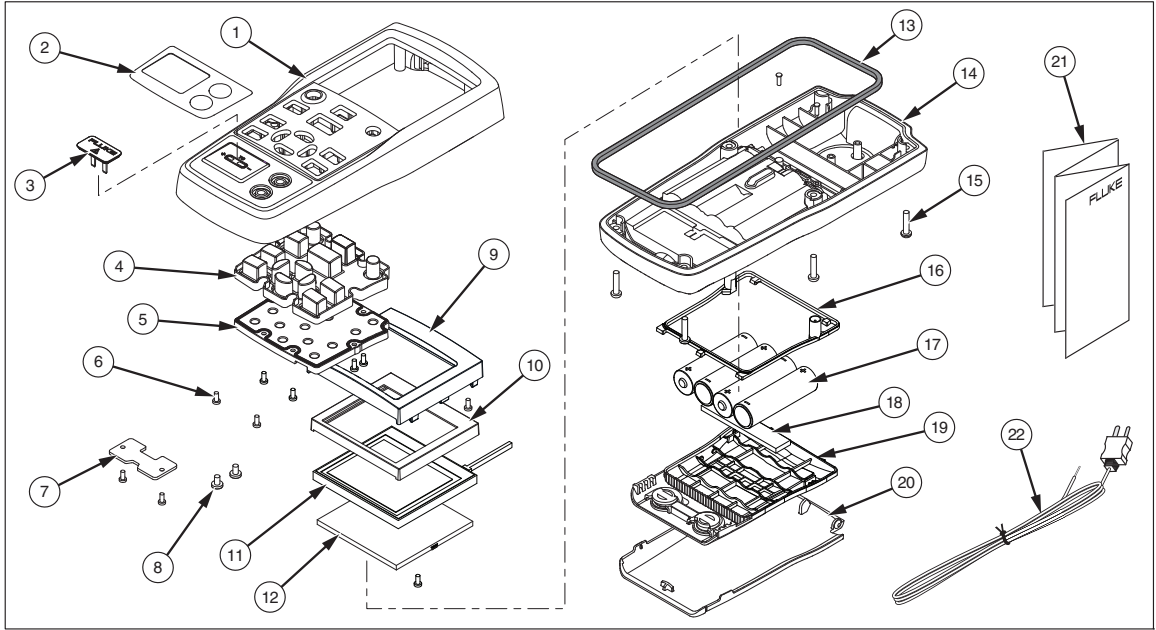

Figure 21. User-Replaceable Parts and Accessories for 714B

hrk46.eps