



GPI Instrument Thread & Weld Fittings



Features

1. All instrument thread fittings are designed in accordance with ASME B31.3 for instrument and process.
2. Male thread are protected with cap.
3. Burr-free internal and outside surfaces.
4. NPT threads are based on requirement of ASME B1.20.1

Pressure Ratings

Size Designator	NPT Size	316 Stainless Steel			
		Male		Female	
		psig	bar	psig	bar
1	1/16	11,000	757	6,700	416
2	1/8	10,000	689	6,500	447
4	1/4	8,000	551	6,600	454
6	3/8	7,800	537	5,300	365
8	1/2	7,700	530	4,900	337
12	3/4	7,300	502	4,600	316
16	1	5,300	365	4,400	303
20	1 ¼	6,000	413	5,000	344
24	1 ½	5,000	344	4,600	316
30	2	3,900	268	3,900	268

How to Order

P



Pipe Fitting

G



GPI

CN

Name of Fitting

4N



Pipe Thread Size

S316



Body Materials

S316: 316 Stainless Steel

Pipe Thread Designation

Pipe Size	Designator	NPT	ISO Thread	
			Tapered (7/1)	Paraller(228/1)
1/8	2	2N	2R	2G
1/4	4	4N	4R	4G
3/8	6	6N	6R	6G
1/2	8	8N	8R	8G
3/4	12	12N	12R	12G
1	16	16N	16R	16G

Close Nipple
(Male NPT both ends)

P-GCN

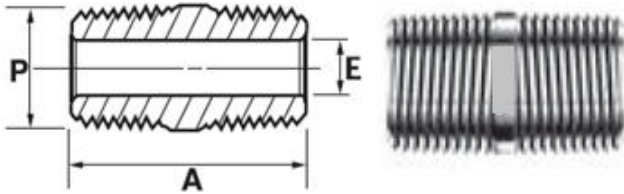

Part.No.	P Size	A	E
P-GCN-2N	1/8"	19.05	4.80
P-GCN-4N	1/4"	28.40	7.10
P-GCN-6N	3/8"	28.40	9.60
P-GCN-8N	1/2"	31.70	11.90
P-GCN-12N	3/4"	31.70	15.70
P-GCN-16N	1"	47.80	22.40

Hex Nipple
(Male NPT both ends)

P-GHN

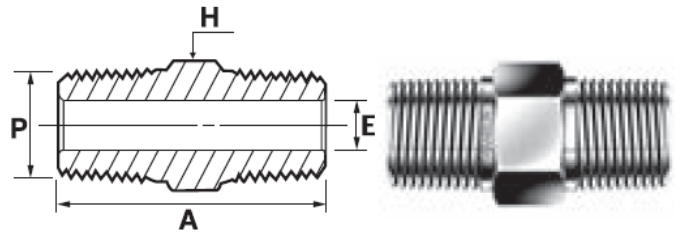

Part.No.	P Size	A	E	H
P-GHN-2N	1/8"	25.40	4.80	11.10
P-GHN-4N	1/4"	35.30	7.10	14.20
P-GHN-6N	3/8"	36.10	9.60	17.40
P-GHN-8N	1/2"	49.70	11.90	22.20
P-GHN-12N	3/4"	46.70	15.70	26.90
P-GHN-16N	1"	58.70	22.30	34.90

Hex Reducing Nipple
(Male NPT to Reduced Male NPT)

P-GHRN

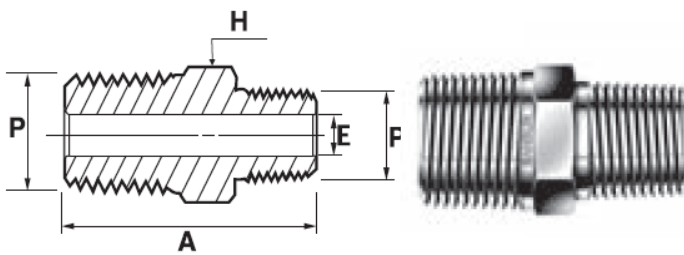

Part.No.	P Pipe Size	P1 Reduced Pipe Size	A	E	H
P-GHRN-4-2N	1/4"	1/8"	30.70	4.80	14.20
P-CHRN-6-2N	3/8"	1/8"	32.00	4.80	17.40
P-GHRN-6-4N	3/8"	1/4"	36.10	7.10	17.40
P-CHRN-8-2N	1/2"	1/8"	37.20	4.80	22.20
P-GHRN-8-4N	1/2"	1/4"	41.70	7.10	22.20
P-CHRN-8-6N	1/2"	3/8"	41.70	9.60	22.20
P-GHRN-12-4N	3/4"	1/4"	41.70	7.10	26.90
P-CHRN-12-8N	3/4"	1/2"	46.70	11.90	26.90
P-GHRN-16-4N	1"	1/4"	49.30	7.10	34.90
P-CHRN-16-8N	1"	1/2"	54.10	11.90	34.90

Hex Nipple
(Male NPT to ISO tapered)

P-GHN

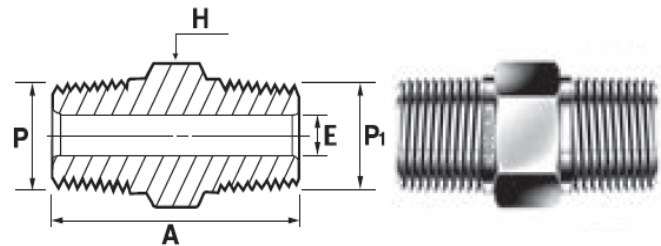

Part.No.	P NPT Size	P1 BSP/ISO Thread	A	E	H
P-GHN-2NR	1/8"	1/8-28 7/1	24.60	4.10	11.10
P-GHN-4NR	1/4"	1/4-19 7/1	35.60	6.40	14.20
P-GHN-6NR	3/8"	3/8-19 7/1	36.30	9.70	17.40
P-GHN-8NR	1/2"	1/2-14 7/1	46.00	11.90	22.20
P-GHN-12NR	3/4"	3/4-14 7/1	46.70	15.70	26.90
P-GHN-16NR	1"	1-11 7/1	58.90	22.40	34.90

Hex Nipple
(Male NPT to Male Parallel)

P-GHN

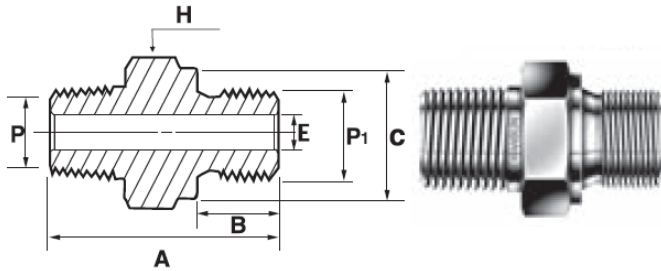

Part.No.	P NPT	P1 BSP/ISO Thread Size	A	B	D	E	H
P-GHN-2NG	1/8"	1/8-28 228/1	27.40	7.10	13.70	4.10	14.20
P-GHN-4NG	1/4"	1/4-19 228/1	36.80	11.20	17.80	5.80	19.05
P-GHN-6NG	3/8"	3/8-19 228/1	37.60	11.20	21.80	7.90	22.20
P-GHN-8NG	1/2"	1/2-14 228/1	45.00	14.20	26.10	11.90	26.90
P-GHN-12NG	3/4"	3/4-14 228/1	49.00	15.70	31.50	15.70	33.30
P-GHN-16NG	1"	1-11 228/1	56.90	18.30	38.90	19.80	41.00

Hex Long Nipple
(Male NPT to both ends)

P-GHLN

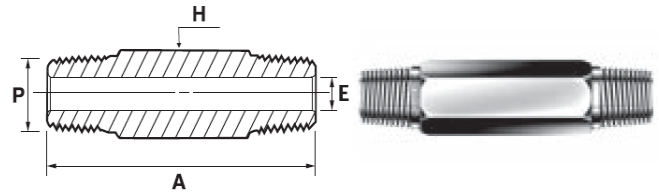

Part.No.	P	A	E	H
P-GHLN-2N	1/8"	●	4.80	11.10
P-GHLN-4N	1/4"	●	7.10	14.20
P-GHLN-6N	3/8"	●	9.70	17.40
P-GHLN-8N	1/2"	●	11.90	22.20
P-GHLN-12N	3/4"	●	15.70	26.90
P-GHLN-16N	1"	●	22.40	34.90

Adapter
(Female NPT to Male NPT)

P-GAA

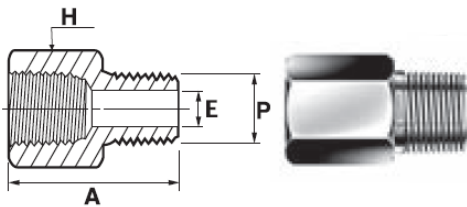

Part.No.	P Pipe Size	A	E	H
P-GAA-2N	1/8"	27.40	4.80	14.20
P-GAA-4N	1/4"	35.60	7.10	19.05
P-GAA-6N	3/8"	37.80	9.60	22.20
P-GAA-8N	1/2"		11.90	26.90
P-GAA-12N	3/4"	50.30	15.70	31.70
P-GAA-16N	1"	58.00	22.30	41.20

Reducing Adapter
(Female NPT to Reduced Male NPT)

P-GRA

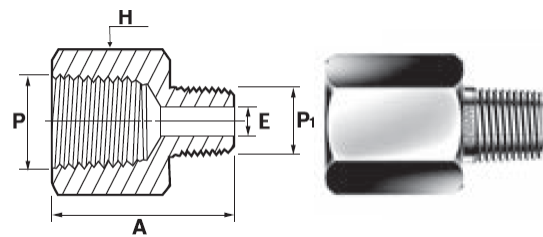

Part.No.	P Female Pipe Size	P Male Pipe Size	A	E	H
P-GRA-2-4N	1/4"	1/8"	31.50	4.80	19.05
P-GRA-2-6N	3/8"	1/8"	33.50	4.80	22.20
P-GRA-4-6N	3/8"	1/4"	37.80	7.10	22.20
P-GRA-2-8N	1/2"	1/8"	40.00	4.80	26.90
P-GRA-4-8N	1/2"	1/4"	44.50	7.10	26.90
P-GRA-6-8N	1/2"	3/8"	44.50	9.60	26.90
P-GRA-4-12N	3/4"	1/4"	45.70	7.10	31.80
P-GRA-6-12N	3/4"	3/8"	45.70	9.60	31.80
P-GRA-8-12N	3/4"	1/2"	51.10	11.90	31.80
P-GRA-4-16N	1"	1/4"	50.80	7.10	41.20
P-GRA-8-16N	1"	1/2"	54.90	11.90	41.20
P-GRA-12-16N	1"	3/4"	55.10	15.70	41.20

Adapter
(Female NPT to Male ISO tapered)

P-GAC

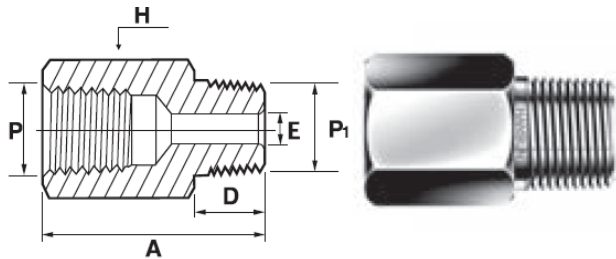

Part.No.	P NPT Thread	P1 BSP/ISO Thread	A	D	E	H
P-GAC-2RN	1/8"	1/8-28 7/1	27.40	9.70	4.80	14.20
P-GAC-4RN	1/4"	1/4-19 7/1	35.80	14.20	7.10	19.05
P-GAC-6RN	3/8"	3/8-19 7/1	37.60	14.20	9.70	22.20
P-GAC-8RN	1/2"	1/2-14 7/1	49.00	19.10	11.90	26.90
P-GAC-12RN	3/4"	3/4-14 7/1	50.30	19.10	15.70	31.80
P-GAC-16RN	1"	1-11 7/1	58.00	23.90	19.80	41.20

Adapter
(Female NPT to Male ISO Parallel)

P-GAB

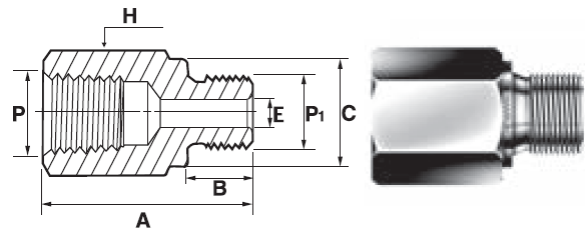

Part.No.	P NPT Thread	P1 BSP/ISO Thread	A	B	C	E	H
P-GAB-2GN	1/8"	1/8-28 228/1	24.90	7.10	13.70	41.00	14.20
P-GAB-4GN	1/4"	1/4-19 228/1	33.30	11.20	17.80	5.80	19.05
P-GAB-6GN	3/8"	3/8-19 228/1	37.80	11.20	21.80	7.90	22.20
P-GAB-8GN	1/2"	1/2-14 228/1	43.90	14.20	26.10	11.90	26.90
P-GAB-12GN	3/4"	3/4-14 228/1	50.80	15.70	31.50	15.70	33.30
P-GAB-16GN	1"	1-11 228/1	53.10	18.30	38.90	19.80	41.20

Reducing Hex Bushing
(Male NPT to Reduced Female NPT)

P-GHB

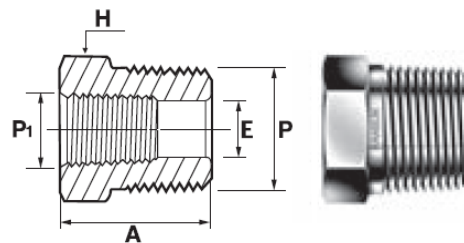

Part.No.	P Male Pipe Size	P1 Female Pipe Size	A	E	H	Working Pressure 316L
P-GHB-4-2N	1/4"	1/8"	26.70	7.10	14.20	5600.00
P-GHB-6-2N	3/8"	1/8"	21.80	8.50	17.40	-
P-GHB-6-4N	3/8"	1/4"	30.00	9.60	19.05	5200.00
P-GHB-8-2N	1/2"	1/8"	27.40	8.50	22.20	-
P-GHB-8-4N	1/2"	1/4"	27.40	11.70	22.20	5800.00
P-GHB-8-6N	1/2"	3/8"	35.60	11.90	22.20	4400.00
P-GHB-12-4N	3/4"	1/4"	27.40	11.40	26.90	-
P-GHB-12-6N	3/4"	3/8"	27.40	15.00	26.90	-
P-GHB-12-8N	3/4"	1/2"	41.40	15.70	26.90	-
P-GHB-16-4N	1"	1/4"	34.80	11.40	34.90	-
P-GHB-16-8N	1"	1/2"	34.80	18.50	34.90	-
P-GHB-16-12N	1"	3/4"	34.80	22.40	34.90	-

Pipe Cap
P-GC

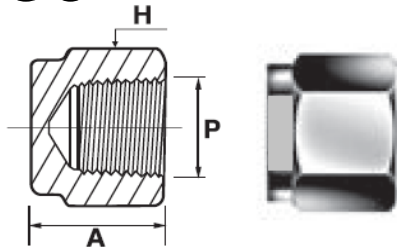

Pipe Plug
(Male NPT)
P-GP

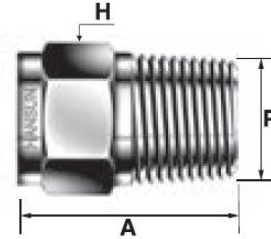

Part.No.	P Pipe Size	A	H
P-GC-2N	1/8"	19.10	14.20
P-GC-4N	1/4"	22.90	19.05
P-GC-6N	3/8"	26.20	22.20
P-GC-8N	1/2"	34.00	26.90
P-GC-12N	3/4"	36.60	31.80
P-GC-16N	1"	41.10	41.20

Part.No.	P Pipe Size	A	H
P-GP-2N	1/8"	19.05	11.10
P-GP-4N	1/4"	24.10	14.20
P-GP-6N	3/8"	25.00	17.40
P-GP-8N	1/2"	30.50	22.20
P-GP-12N	3/4"	30.50	26.90
P-GP-16N	1"	38.10	34.90

Hex Coupling
(Female NPT both ends)
P-GHC

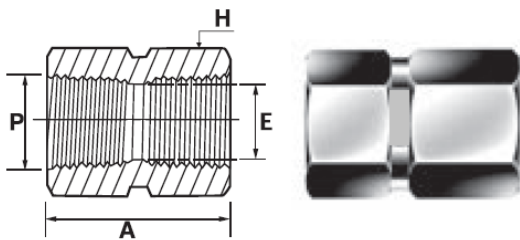

Hex Reducing Coupling
(Female NPT to Reduced Female NPT)
P-GHRC

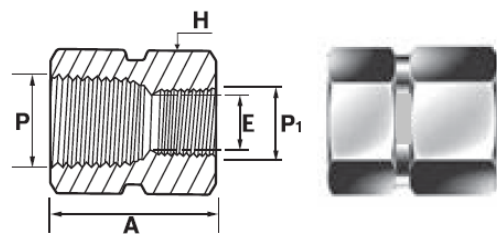

Part.No.	P Pipe Size	A	E	H
P-GHC-2N	1/8"	20.30	8.90	14.20
P-GHC-4N	1/4"	30.00	11.70	19.05
P-GHC-6N	3/8"	33.00	15.00	22.20
P-GHC-8N	1/2"	39.40	18.70	26.90
P-GHC-12N	3/4"	41.00	23.50	31.80
P-GHC-16N	1"	50.50	29.70	41.20

Part.No.	P Pipe Size	P Reduced Pipe Size	A	E	H
P-GHRC-4-2N	1/4"	1/8"	31.20	8.90	19.05
P-GHRC-6-4N	3/8"	1/4"	34.80	11.70	22.20
P-GHRC-8-2N	1/2"	1/8"	39.40	8.70	26.90
P-GHRC-8-4N	1/2"	1/4"	44.20	11.70	26.90
P-GHRC-8-6N	1/2"	3/8"	45.00	15.00	26.90
P-GHRC-12-4N	3/4"	1/4"	45.70	11.70	31.80
P-GHRC-12-8N	3/4"	1/2"	52.00	18.70	31.80
P-GHRC-16-4N	1"	1/4"	50.80	11.70	41.20
P-GHRC-16-8N	1"	1/2"	55.40	18.70	41.20
P-GHRC-16-12N	1"	3/4"	57.00	23.50	41.20

Elbow
(Female NPT both ends)

P-GL

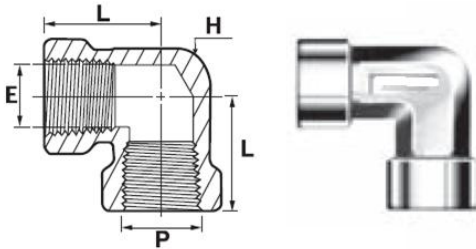

Street Elbow
(Female to Male NPT)

P-GS L

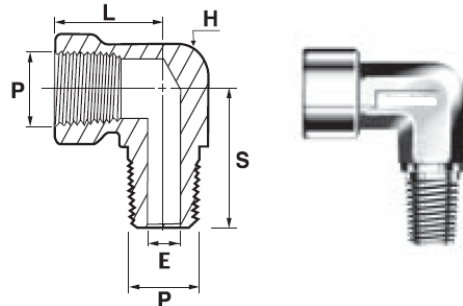

Part.No.	P Pipe Size	L	E	H Wrench Flat
P-GL-2N	1/8"	24.10	8.90	12.70
P-GL-4N	1/4"	29.00	11.70	17.50
P-GL-6N	3/8"	34.50	15.00	20.60
P-GL-8N	1/2"	37.00	18.70	25.40
P-GL-12N	3/4"	46.50	23.50	31.80
P-GL-16N	1"	48.80	29.70	42.90

Part.No.	P Pipe Size	L	S	E	H
P-GSL-2N	1/8"	24.10	19.60	4.80	12.70
P-GSL-4N	1/4"	29.00	26.50	7.10	17.50
P-GSL-6N	3/8"	34.50	28.20	9.60	20.60
P-GSL-8N	1/2"	37.00	35.30	11.90	25.40
P-GSL-12N	3/4"	46.50	39.60	15.70	31.80
P-GSL-16N	1"	48.80	49.20	22.30	42.90

Reducing Street Elbow
(Female to Male NPT)

P-GRSL

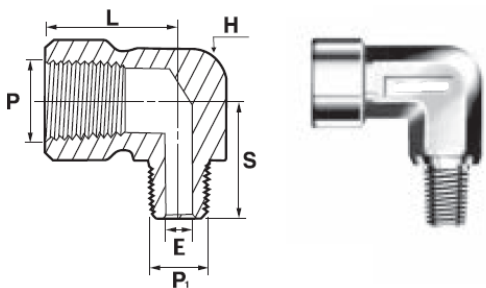

Male Elbow
(Male NPT both ends)

P-GML

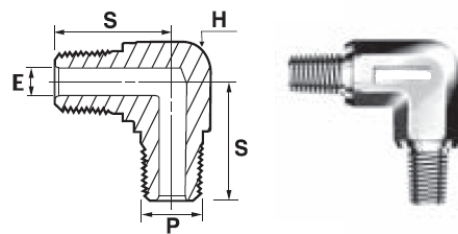

Part.No.	P Pipe Size	P Male Pipe Size	L	S	E	H
P-GRSL-4-2N	1/4"	1/4"	29.00	22.40	4.80	17.50
P-GRSL-6-4N	3/8"	3/8"	34.50	28.20	7.10	20.60
P-GRSL-8-4N	1/2"	1/2"	37.00	30.50	7.10	25.40
P-GRSL-8-6N	1/2"	1/2"	37.00	30.50	9.60	25.40
P-GRSL-12-8N	3/4"	3/4"	46.50	39.60	11.90	31.80
P-GRSL-16-8N	1"	1"	48.80	44.50	11.90	42.90

Part.No.	P Pipe Size	S	E	H
P-GML-2N	1/8"	19.05	4.80	12.70
P-GML-4N	1/4"	24.50	7.10	12.70
P-GML-6N	3/8"	26.90	9.60	17.50
P-GML-8N	1/2"	33.20	11.90	20.60
P-GML-12N	3/4"	35.30	15.70	25.40
P-GML-16N	1"	44.50	22.30	31.80

Tee
(Female NPT)

P-GT

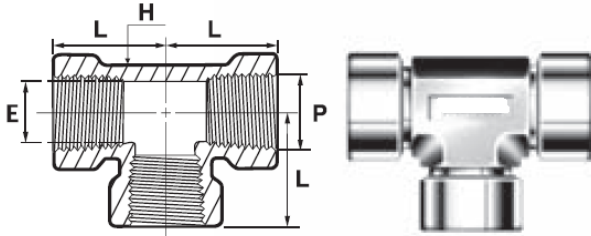

Run Tee
(Female to Male to Female NPT)

P-GRT

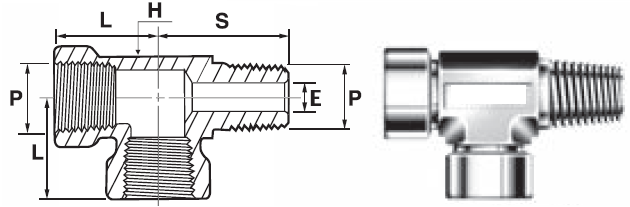

Part.No.	P Pipe Size	L	E	H
P-GT-2N	1/8"	24.10	8.90	12.70
P-GT-4N	1/4"	29.00	11.70	17.50
P-GT-6N	3/8"	34.50	15.00	20.60
P-GT-8N	1/2"	37.00	18.70	25.40
P-GT-12N	3/4"	46.50	23.50	31.80
P-GT-16N	1"	48.50	29.70	42.80

Part.No.	P Pipe Size	L	S	E	H
P-GRT-2N	1/8"	24.10	19.60	4.80	12.70
P-GRT-4N	1/4"	29.00	26.50	7.10	17.50
P-GRT-6N	3/8"	34.50	28.20	9.60	20.60
P-GRT-8N	1/2"	37.00	35.30	11.90	25.40
P-GRT-12N	3/4"	46.50	39.60	15.70	31.80
P-GRT-16N	1"	48.80	49.20	22.30	42.90

Branch Tee
(Female to Male to Male NPT)

P-GBT

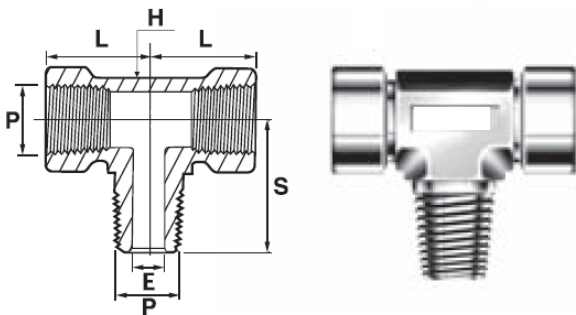

Male Tee
(Male NPT)

P-GMT

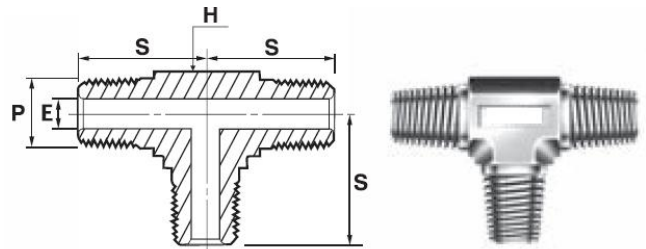

Part.No.	P Pipe Size	L	S	E	H
P-GBT-2N	1/8"	24.10	19.60	4.80	12.70
P-GBT-4N	1/4"	29.00	26.50	7.10	17.50
P-GBT-6N	3/8"	34.50	28.20	9.60	20.60
P-GBT-8N	1/2"	37.00	35.30	11.90	25.40
P-GBT-12N	3/4"	46.50	39.60	15.70	31.80
P-GBT-16N	1"	48.80	49.20	22.30	42.90

Part.No.	P Pipe Size	S	E	H
P-GMT-2N	1/8"	19.05	4.80	12.70
P-GMT-4N	1/4"	24.50	7.10	12.70
P-GMT-6N	3/8"	26.90	9.60	17.50
P-GMT-8N	1/2"	33.20	11.90	20.60
P-GMT-12N	3/4"	35.30	15.70	25.40

Union Ball Joint
(Female NPT both ends)

P-GUJ

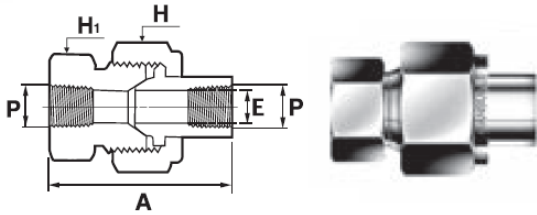

ISO Parallel Gasket

P-GSG

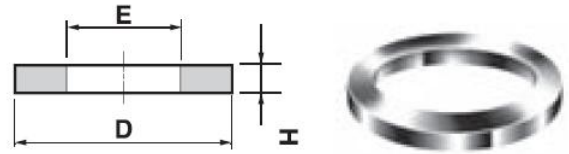

Part.No.	P Pipe Size	A	E	H	H1
P-GUJ-F-2N	1/8"	45.70	6.90	28.60	23.80
P-GUJ-F-2N	1/4"	59.40	9.10	34.90	30.20
P-GUJ-F-8N	3/8"	63.50	13.20	38.10	33.30
P-GUJ-F-8N	1/2"	68.60	15.70	44.50	41.30
P-GUJ-F-12N	3/4"	79.20	22.40	50.80	47.60
P-GUJ-F-16N	1"	90.40	26.20	63.50	60.30

Part.No.	P Pipe Size	E	H	D
P-GSG-2N	1/8"	10.00	2.00	18.00
P-GSG-4N	1/4"	14.00	2.00	22.00
P-GSG-6N	3/8"	17.00	2.00	26.00
P-GSG-8N	1/2"	22.00	2.00	32.00
P-GSG-12N	3/4"	27.00	2.00	38.00
P-GSG-16N	1"	34.00	2.00	42.00

Union
P-GWU

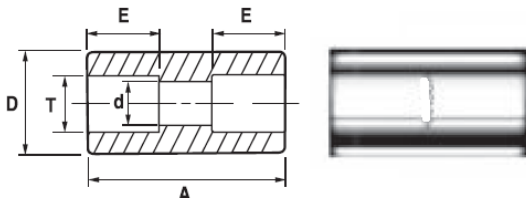

Union Elbow
P-GWLA

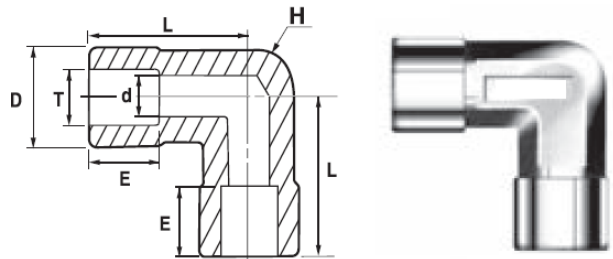

Part.No.	T Tube O.D	d	D	E	A	Working Pressure psig	Working Pressure Bar
P-GWU-4T	1/4"	4.60	13.00	7.10	19.00	10,000	689.0
P-GWU-6T	3/8"	7.10	15.80	7.90	22.40	7,600	523.0
P-GWU-8T	1/2"	10.20	19.00	9.70	26.90	6,200	427.0
P-GWU-10T	5/8"	12.70	24.00	10.40	30.20	6,400	440.0
P-GWU-12T	3/4"	15.70	26.90	11.20	33.30	5,500	378.0
P-GWU-16T	1"	22.10	35.00	15.70	36.60	5,200	358.0

Part.No.	T Tube O.D	d	D	E	H Wrench Flat	L	Working Pressure psig	Working Pressure Bar
P-GWLA-4T	1/4"	4.60	13.40	7.10	12.70	21.80	11,300	778
P-GWLA-6T	3/8"	7.10	15.80	7.90	12.70	24.50	8,400	578
P-GWLA-8T	1/2"	10.20	20.60	9.70	17.40	29.00	7,800	537
P-GWLA-10T	5/8"	12.70	23.80	10.40	20.60	34.50	6,700	461
P-GWLA-12T	3/4"	15.70	28.60	11.20	25.40	37.00	6,700	461
P-GWLA-16T	1"	22.10	35.00	15.70	31.80	46.50	6,100	420

Union Tee

P-GWTA

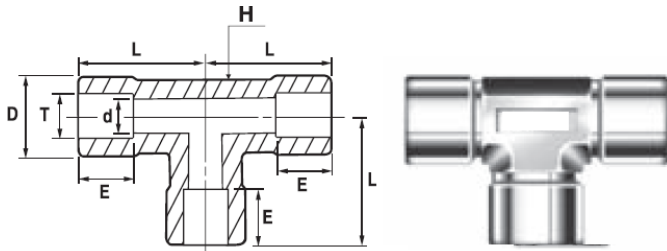

Part.No.	T Tube O.D	d	D	E	H Wrench Flat	L	Working Pressure psig	Working Pressure Bar
P-GWTA-2T	1/8"	2.30	13.40	2.50	12.70	15.00	11,800	813
P-GWTA-4T	1/4"	4.60	13.40	7.10	12.70	21.80	11,300	778
P-GWTA-6T	3/8"	7.10	15.80	7.90	12.70	24.50	8,400	578
P-GWTA-8T	1/2"	10.20	20.60	9.70	17.40	29.00	7,800	537
P-GWTA-10T	5/8"	12.70	23.80	10.40	20.60	34.50	6,700	461
P-GWTA-12T	3/4"	15.70	28.60	11.20	25.40	37.00	6,700	461
P-GWTA-16T	1"	22.10	35.00	15.70	31.80	46.50	6,100	420

Male Connector

P-GWMC

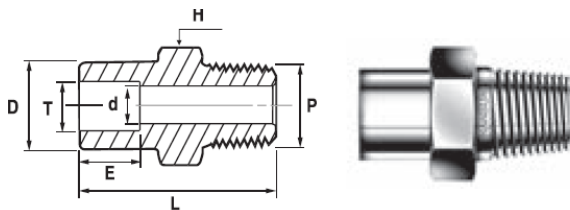

Part.No.	T Tube O.D	P- NPT	d	D	E	H Hex	L	Working Pressure psig	Working Pressure Bar
P-GWMC-4T-2N	1/4"	1/4"	4.6	1.20	7.10	14.20	29.20	7,500	516
P-GWMC-6T-4N	3/8"	1/4"	7.1		7.90	15.80	31.80	7,500	516
P-GWMC-6T-6N	3/8"	3/8"	7.1	15.30	7.90	17.40	31.80	7,300	502
P-GWMC-6T-8N	3/8"	1/2"	7.1	15.30	7.90	22.20	37.30	7,200	496
P-GWMC-8T-4N	1/2"	1/4"	7.1	18.50	9.70	19.05	33.30	6,200	427
P-GWMC-8T-6N	1/2"	3/8"	9.4	18.50	9.70	19.05	33.30	6,200	427
P-GWMC-8T-8N	1/2"	1/2"	10.2	18.50	9.70	22.20	38.90	6,200	427

Female Connector

P-GWFC

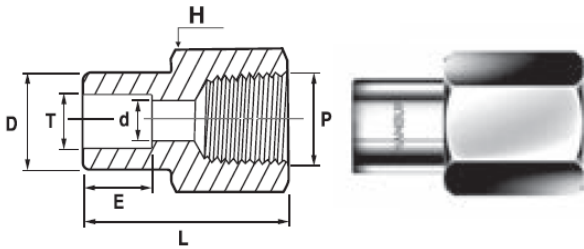

Part.No.	T Tube O.D	P-NPT Female Pipe	d	D	E	H Hex	L	Working Pressure psig	Working Pressure Bar
P-GWFC-2T-2N	1/8"	1/8"	2.30	7.40	2.50	14.20	21.10	6,100	420
P-GWFC-4T-2N	1/4"	1/8"	4.60	12.20	7.10	14.20	26.70	6,100	420
P-GWFC-4T-4N	1/4"	1/4"	4.60	12.20	7.10	19.05	30.00	6,200	427
P-GWFC-6T-4N	3/8"	1/4"	7.10	15.30	7.90	19.05	31.50	6,200	427
P-GWFC-8T-6N	1/2"	3/8"	10.20	18.50	9.70	22.20	34.50	5,000	344
P-GWFC-8T-8N	1/2"	1/2"	10.20	18.50	9.70	26.90	40.40	4,600	316
P-GWFC-10T-8N	5/8"	1/2"	12.70	23.40	10.40	24.90	41.90	4,600	316
P-GWFC-12T-12N	3/4"	3/4"	15.70	26.70	11.20	33.30	43.90	4,300	296

Male Elbow

P-GWML

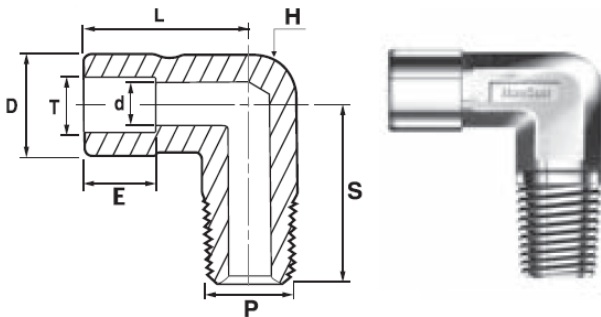

Part.No.	T Tube O.D	P- NPT	d	D	E	H Hex	L	S	Working Pressure psig	Working Pressure Bar
P-GWML-4T-4N	1/4"	1/4"	4.60	15.80	7.10	12.70	20.10	24.50	7,500	516
P-GWML-6T-4N	3/8"	1/4"	7.10	15.80	7.90	12.70	24.10	24.50	7,500	516
P-GWML-6T-6N	3/8"	3/8"	7.10	20.60	7.90	17.40	24.60	29.00	7,300	502
P-GWML-6T-8N	3/8"	1/2"	7.10	23.80	7.90	20.60	25.90	34.50	7,200	496
P-GWML-8T-8N	1/2"	1/2"	10.20	23.80	9.70	20.60	27.40	34.50	6,200	427
P-GWML-12T-12N	3/4"	3/4"	15.70	28.60	11.20	25.40	37.00	37.00	6,700	461

Female Elbow

P-GWFL

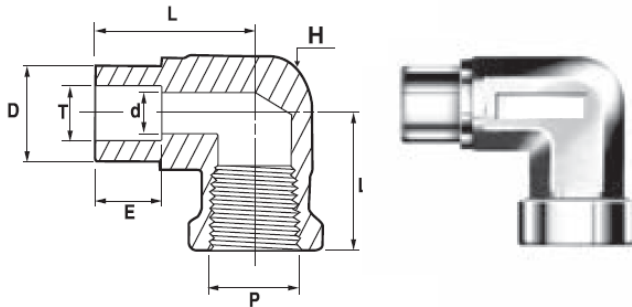

Part.No.	T Tube O.D	P-NPT Female Pipe	d	D	E	H Hex	L	L1	Working Pressure psig	Working Pressure Bar
P-GWFL-4T-4N	1/4"	1/4"	4.60	12.20	7.10	17.40	22.90	29.70	6,200	427
P-GWFL-6T-4N	3/8"	1/4"	7.10	15.30	7.90	17.40	25.10	29.70	7,000	482
P-GWFL-6T-8N	3/8"	1/2"	7.10	15.30	7.90	25.40	28.70	37.00	5,400	372
P-GWFL-8T-8N	1/2"	1/2"	10.20	18.50	9.70	25.40	30.20	37.00	5,400	372

Pipe Weld to Tube Socket Weld

P-GWRM

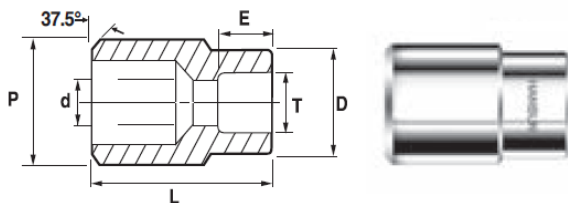

Part.No.	T Tube O.D	T Tube Socket	d	D	E	L	Working Pressure psig	Working Pressure Bar
P-GWRM-4P-4T	1/4"	1/4"	4.60	13.70	7.10	22.40	9,600	661
P-GWRM-6P-6T	3/8"	3/8"	7.10	15.30	7.90	26.20	7,600	523
P-GWRM-6P-8T	3/8"	1/2"	10.20	18.50	9.70	27.90	6,200	427
P-GWRM-8P-4T	1/2"	1/4"	4.60	12.20	7.10	28.40	7,300	502
P-GWRM-8P-6T	1/2"	3/8"	7.10	15.30	7.90	28.40	7,300	502
P-GWRM-8P-8T	1/2"	1/2"	10.20	18.50	9.70	30.20	6,200	427
P-GWRM-12P-6T	3/4"	3/8"	7.10	15.30	7.90	38.10	6,200	427
P-GWRM-12P-8T	3/4"	1/2"	10.20	18.50	9.70	38.10	6,200	427

Tube Weld to Tube Socket Weld

P-GWRM

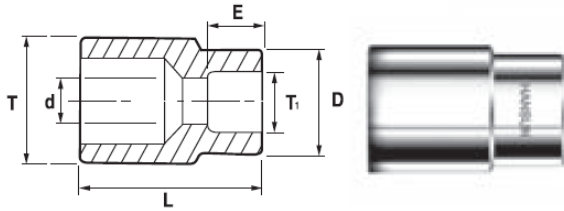

Part.No.	T Tube O.D	T Tube Socket O.D	d	D	E	L	Working Pressure psig	Working Pressure Bar
P-GWRM-4T-2T	1/8"	1/4"	2.30	7.40	2.50	14.20	11,800	813
P-GWRM-6T-4T	3/8"	3/8"	4.60	12.20	7.10	19.10	7,700	530
P-GWRM-8T-4T	1/2"	1/4"	4.60	18.20	7.10	22.40	7,000	482
P-GWRM-8T-6T	1/2"	3/8"	8.10	15.70	7.90	22.40	7,000	482
P-GWRM-12T-8T	3/4"	1/2"	10.20	18.50	9.70	28.40	5,900	406
P-GWRM-16T-8T	1"	1/2"	10.20	18.50	9.70	35.10	5,600	344



GP International

5619, Daejeo 2-dong, Gangseo-gu, Busan, Korea (46723)

Tel: +82 51 294 2330 / Fax: +82 51 294 2331

E-mail: gpi@gp-international.co.kr (English)

sales@gp-international.co.kr (Chinese)

Website : www.gp-international.co.kr