

Rosemount™ DIN-Style Temperature Sensors and Thermowells (Metric)



- RTDs (0065) and thermocouples (0185) available to meet any process requirement
- DIN-style for easy installation and replacement
- Integrated temperature assembly with Rosemount transmitters available

Rosemount DIN-Style Temperature Sensor and Thermowells

Optimize plant efficiency and increase measurement reliability with industry-proven design and specifications

- Available in a wide variety of sensing technologies – RTD and thermocouples.
- All sensor styles and lengths are available in 6 mm diameter.
- State of the art manufacturing procedures provide robust element packaging and increasing reliability.
- Industry-leading calibration capabilities allow for Callendar-Van Dusen values to give increased accuracy when paired with Rosemount transmitters.
- Optional Class A accuracy for critical temperature measurement points.

Streamline operations and maintenance with sensor and thermowell design

- DIN-style sensor uses connection heads that allow quick mounting and replacement while maintaining environmental integrity.
- Terminal block, flying leads, and spring loaded threaded adapter styles offer remote or integral transmitter mounting configuration.

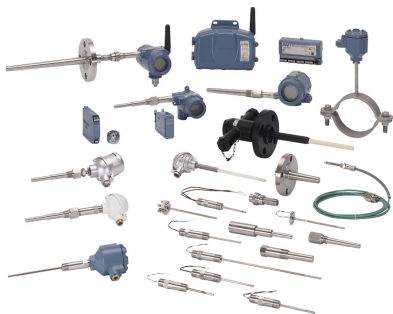

Explore the benefits of Complete Point Solutions™ from Emerson

- An “Assemble Sensor to Specific Transmitter” option enables Emerson to provide a complete point temperature solution, delivering an installation-ready transmitter and sensor assembly.
- Emerson has a complete portfolio of single point and high density temperature measurement solutions, allowing you to effectively measure and control your processes with the reliability you trust from Rosemount products.



Experience global consistency and local support from numerous worldwide Rosemount Temperature manufacturing sites

- World-class manufacturing provides globally consistent products from every factory and the capacity to fulfill the needs of any project, large or small.
- Experienced instrumentation consultants help select the right product for any temperature application and advise on best installation practices.
- An extensive global network of Emerson service and support personnel can be on-site when and where they are needed.

Content

Rosemount DIN-Style Sensor and Thermowell	3	Product Certifications	26
Rosemount Series 96 Barstock Thermowell	18	Sensor-to-Transmitter Matching	30
Sensor reference information	22	Accessories	38
Specifications	24	Wake frequency calculation	41

Rosemount DIN-Style Sensor and Thermowell

The Rosemount DIN-Style Sensor and Thermowell have designs that provide flexible and reliable temperature measurements in process environments.

Features include:

- Temperature range of –196 to 450 °C for RTD, –40 to 1000 °C for thermocouple
- Industry-standard sensor types, including RTD and thermocouple varieties
- DIN-style design for easy mounting and replacement
- Variety of enclosure and connection head options
- Global hazardous-location approvals available
- Calibration services available to give you insight to sensor performance
- MID calibration options for custody transfer
- Assemble to transmitter option



Specification and selection of product materials, options, or components must be made by the purchaser of the equipment. See [page 25](#) for more information on material selection.

Table 1. Series 65 Platinum RTD and 185 Thermocouple Without Thermowell

The starred offerings (★) represent the most common options and should be selected for best delivery. The non-starred offerings are subject to additional delivery lead time.

Model	Product description			
0065	Pt 100 RTD (IEC 751) without thermowell			
0185	Thermocouple (IEC 584 Class 1) without thermowell			
Connection head		IP rating ⁽¹⁾	Conduit/cable entry	
C	Rosemount aluminum	66/68	M20 × 1.5	★
D	Rosemount aluminum	66/68	1/2-in. NPT	★
1	Rosemount aluminum with LCD display meter cover	66/68	M20 × 1.5	★
2	Rosemount aluminum with LCD display meter cover	66/68	1/2-in. NPT	★
N	No connection head	N/A	N/A	★
G	Rosemount stainless steel	66/68	M20 × 1.5	
H	Rosemount stainless steel	66/68	1/2-in. NPT	
J	GR-A/BL (BUZ) aluminum w/cable gland	65	M20 × 1.5	
L	TZ-A/BL (BUZH) aluminum w/cable gland	65	M20 × 1.5	
7	Aluminum dual entry head	66	2 × 3/4-in. NPT	
8	Aluminum dual entry head	66	2 × M20 × 1.5	
9	Aluminum dual entry head	66	2 × 1/2-in. NPT	
K	Stainless steel dual entry head	66	2 × 3/4-in. NPT	
R	Stainless steel dual entry head	66	2 × M20 × 1.5	
Connection head		IP rating ⁽¹⁾	Conduit/cable entry	
W	Stainless steel dual entry head	66	2 × 1/2-in. NPT	
A	TZ-A/BL (BUZH) aluminum coated	65	M20 × 1.5	
P	SD-BK	N/A	M20 × 1.5	

Table 1. Series 65 Platinum RTD and 185 Thermocouple Without Thermowell

The starred offerings (★) represent the most common options and should be selected for best delivery. The non-starred offerings are subject to additional delivery lead time.

Sensor lead wire termination					
0	Flying leads (no springs on DIN plate)			★	
2	Terminal block (DIN 43762)			★	
3	Spring loaded adapter (1/2-in. NPT)			★	
Sensor type			Temperature range		
65 Only	1	RTD, single element, 4-wire	-50 to 450 °C (-58 to 842 °F)		★
	2	RTD, dual element, 3-wire	-50 to 450 °C (-58 to 842 °F)		★
	3	RTD, single element, 4-wire	-196 to 300 °C (-321 to 572 °F)		★
	4	RTD, dual element, 3-wire	-196 to 300 °C (-321 to 572 °F)		★
185 Only	03J1	Thermocouple, Type J, single element, ungrounded	-40 to 750 °C (-40 to 1382 °F)		★
	03K1	Thermocouple, Type K, single element, ungrounded	-40 to 1000 °C (-40 to 1832 °F)		★
	05J1	Thermocouple, Type J, dual element, isolated, ungrounded	-40 to 750 °C (-40 to 1382 °F)		★
	05K1	Thermocouple, Type K, dual element, isolated, ungrounded	-40 to 1000 °C (-40 to 1832 °F)		★
65 Only	7	RTD, Single element, 3-wire vibration resistance	-60 to 600 °C (-76 to 1112 °F)		
	9	RTD, Single element, 4-wire vibration resistance	-60 to 600 °C (-76 to 1112 °F)		
	0	RTD, Dual Element, 3-wire vibration resistance	-60 to 600 °C (-76 to 1112 °F)		
185 Only	03N1	Thermocouple, Type N, single element, ungrounded	-40 to 1000 °C (-40 to 1832 °F)		
	05N1	Thermocouple, Type N, dual element, isolated, ungrounded	-40 to 1000 °C (-40 to 1832 °F)		
Extension		Head connection	Instrument connection	Material	
D	DIN Standard 12 × 1.5	M24 × 1.5	1/2-in. NPT	300 series stainless steel	★
T	DIN Standard 12 × 1.5	M24 × 1.5	M18 × 1.5	300 series stainless steel	★
F	Nipple union nipple	1/2-in. NPT	1/2-in. NPT	300 series stainless steel	★
J	Nipple union (M/F)	N/A	1/2-in. NPT	300 series stainless steel	★
N	No extension (only available with connection head code N)				★
W	No extension head connection M24 × 1.5				★
L	No extension head connection 1/2-in. NPT				★
Extension length (N) in millimeters					
0000	No extension (use with extension code N, W, or L)				★
0035	35 mm				★
0080	80 mm (standard for extension type code J)				★
0110	110 mm (standard for extension type codes F and J)				★
0135	135 mm (standard for DIN extension used with Rosemount connection head material codes C, D, G, H, 1, and 2)				★
0150	150 mm (standard for DIN extension used with form B connection head material codes J and L)				★
XXXX	Non-standard extension length (available from 35 to 500 mm in 5 mm increments)				

Table 1. Series 65 Platinum RTD and 185 Thermocouple Without Thermowell

The starred offerings (★) represent the most common options and should be selected for best delivery. The non-starred offerings are subject to additional delivery lead time.

Thermowell material		
N	No thermowell	★
Sensor length (L) in millimeters		
0145	145 mm	★
0205	205 mm	★
0275	275 mm	★
0315	315 mm	★
0375	375 mm	★
0405	405 mm	★
0435	435 mm	★
0555	555 mm	★
XXXX	Non-standard sensor length (available from 100 to 9999 mm in 5-mm increments)	

Options (include with selected model number)

Sensor options (available with 65 only)		Temperature range	
A1	Single element class A sensor	-50 to 300 °C (-58 to 572 °F) (0 -350 °C for sensor types 7, 9, 0)	★
A2	Dual element class A sensor	-50 to 300 °C (-58 to 572 °F) (0 -350 °C for sensor types 7, 9, 0)	★
Product certifications ⁽²⁾			
I1	ATEX Intrinsic Safety Approval		★
N1	ATEX Type n Approval		★
E1	ATEX Flameproof Approval		★
ND	ATEX Dust Approval		★
K1	ATEX Flameproof, Intrinsic Safety, Type n, and Dust Approval		★
E7	IECEx Flameproof Approval		★
E5	US Explosionproof Approval		★
E4	TIIS Flameproof Approval (consult factory for availability)		★
E6	Canada Explosionproof Approval		★
E2	Brazil Flameproof Approval		★
KD	US Explosionproof, Canada Explosionproof, and ATEX Flameproof Approval		★
KM	Technical Regulations Customs Union (EAC) Flameproof, Intrinsic Safety Approval		★
IM	Technical Regulations Customs Union (EAC) Intrinsic Safety Approval		★
EM	Technical Regulations Customs Union (EAC) Flameproof Approval		★
Ground screw			
G1	External ground screw (only available with Rosemount connection head codes C, D, G, H, 1, and 2)		★

Table 1. Series 65 Platinum RTD and 185 Thermocouple Without Thermowell

The starred offerings (★) represent the most common options and should be selected for best delivery. The non-starred offerings are subject to additional delivery lead time.

Cable glands		
G2	Cable gland, EEx d, brass, diam 7.5–11.9 mm	
G4	Cable gland, M20 × 1.5 EMV, brass nickel coated, diam 9–13 mm	
G5	Cable gland, M20 × 1.5 EMV, brass nickel coated, diam 5–13 mm	
G7	Cable gland, M20 × 1.5, EEx e, blue, polyamide, diam 5–9 mm	
Cover chain option		
G3	Cover chain (only available with Rosemount connection head codes C, D, G, and H)	★
Extension ring		
G6	Aluminum extension ring for dual transmitter mounting (use with Rosemount connection head codes C and D)	★
Termination		
TB	Terminal block for use with sensor termination code 3	★
Assemble to option		
XA ⁽³⁾	Assemble sensor to specific temperature transmitter (PTFE paste)	★
Sensor calibration with works certificate (available with 65 only)		
V10	Sensor calibration from –50 to 450 °C (–58 to 842 °F) with A, B, C, and Callendar-Van Dusen constants	★
V11	Sensor calibration from 0 to 100 °C (32 to 212 °F) with A, B, C, and Callendar-Van Dusen constants	★
X8	Sensor calibration over specified temperature range with A, B, C, and Callendar-Van Dusen constants	★
VS system calibration (available with 65 only)		
MD1	MID custody transfer, –196 to 0 °C (–321 to 32 °F)	★
MD2	MID custody transfer, –50 to 100 °C (–58 to 212 °F)	★
MD3	MID custody transfer, 50 to 200 °C (122 to 392 °F)	★
GOST calibration certificate		
QG	Russian GOST Verification Certificate	★
Temperature range option		
LT	Special materials to meet extended temperature range of –51 °C (–60 °F)	★
Typical model number: 0065 C 2 3 D 0150 N 0315 A1		

1. To maintain IP rating, use a suitable cable gland on the conduit connection thread. All threads must be sealed with a suitable sealing tape.
2. Refer to [Table 7 on page 29](#) for limitation on options available with approvals.
3. If ordering Assemble To Option XA with a transmitter, specify the same option on the transmitter model number.

Specification and selection of product materials, options, or components must be made by the purchaser of the equipment. See page 25 for more information on material selection.

Table 2. Series 65 Platinum RTD and 185 Thermocouple With Tubular Thermowell

★ The Standard offering represents the most common options. The starred options (★) should be selected for best delivery lead time. The Expanded offering is subject to additional delivery lead time

Model	Product description			
0065	Pt 100 RTD (IEC 751) with tubular thermowell			
0185	Thermocouples (IEC 584 Class 1) with tubular thermowell			
Connection head		IP rating ⁽¹⁾	Conduit/cable entry	
C	Rosemount aluminum	66/68	M20 × 1.5	★
D	Rosemount aluminum	66/68	1/2-in. NPT	★
1	Rosemount aluminum with LCD display meter cover	66/68	M20 × 1.5	★
2	Rosemount aluminum with LCD display meter cover	66/68	1/2-in. NPT	★
N	No connection head	N/A	N/A	★
G	Rosemount stainless steel	66/68	M20 × 1.5	
H	Rosemount stainless steel	66/68	1/2-in. NPT	
J	GR-A/BL (BUZ) aluminum w/ cable gland	65	M20 × 1.5	
L	TZ-A/BL (BUZH) aluminum w/ cable gland	65	M20 × 1.5	
7	Aluminum dual entry head	66	2 × 3/4-in. NPT	
8	Aluminum dual entry head	66	2 × M20 × 1.5	
9	Aluminum dual entry head	66	2 × 1/2-in. NPT	
K	Stainless steel dual entry head	66	2 × 3/4-in. NPT	
R	Stainless steel dual entry head	66	2 × M20 × 1.5	
W	Stainless steel dual entry head	66	2 × 1/2-in. NPT	
A	TZ-A/BL (BUZH) aluminum coated	65	M20 × 1.5	
P	SD-BK	N/A	M20 × 1.5	
Sensor lead wire termination				
0	Flying leads (no springs on DIN plate)			★
2	Terminal block (DIN 43762)			★
Sensor type			Temperature range	
65 only	1	RTD, single element, 4-wire	- 50 to 450 °C (-58 to 842 °F)	★
	2	RTD, dual element, 3-wire	-50 to 450 °C (-58 to 842 °F)	★
	3	RTD, single element, 4-wire	-196 to 300 °C (-321 to 572 °F)	★
	4	RTD, dual element, 3-wire	-196 to 300 °C (-321 to 572 °F)	★
185 only	03J1	Thermocouple, Type J, single element, ungrounded	-40 to 750 °C (-40 to 1382 °F)	★
	03K1	Thermocouple, Type K, single element, ungrounded	-40 to 1000 °C (-40 to 1832 °F)	★
	05J1	Thermocouple, Type J, dual element, isolated, ungrounded	-40 to 750 °C (-40 to 1382 °F)	★
	05K1	Thermocouple, Type K, dual element, isolated, ungrounded	-40 to 1000 °C (-40 to 1832 °F)	★

Table 2. Series 65 Platinum RTD and 185 Thermocouple With Tubular Thermowell

★ The Standard offering represents the most common options. The starred options (★) should be selected for best delivery lead time. The Expanded offering is subject to additional delivery lead time

Sensor type		Temperature range		
65 only	7	RTD, single element, 3-wire vibration resistance	-60 to 600 °C (-76 to 1112 °F)	
	9	RTD, single element, 4-wire vibration resistance	-60 to 600 °C (-76 to 1112 °F)	
	0	RTD, dual element, 3-wire vibration resistance	-60 to 600 °C (-76 to 1112 °F)	
185 only	03N1	Thermocouple, Type N, single element, ungrounded	-40 to 1000 °C (-40 to 1832 °F)	
	05N1	Thermocouple, Type N, dual element, isolated, ungrounded	-40 to 1000 °C (-40 to 1832 °F)	
Extension				
Y	Tubular, no extension (only available with form GN)			★
Z	Tubular, with extension (only available with form GB, NAMUR)			★
Extension length (N) in millimeters				
0000	No extension (use with extension code Y)			★
0050	50 mm			★
0065	65 mm			★
0105	105 mm			★
0115	115 mm			★
0130	130 mm			★
0200	200 mm			★
0250	250 mm			★
XXXX	Non-standard extension length (available from 50 to 500 mm in 5 mm increments)			
Thermowell material				
D	1.4404 (316L SST)			★
Y	1.4571 (316Ti SST)			★
Immersion length (U)				
0050	50 mm			★
0075	75 mm			★
0100	100 mm			★
0115	115 mm			★
0130	130 mm			★
0150	150 mm			★
0160	160 mm			★
0200	200 mm			★
0220	220 mm			★
0225	225 mm			★
0250	250 mm			★
0280	280 mm			★
0300	300 mm			★

Table 2. Series 65 Platinum RTD and 185 Thermocouple With Tubular Thermowell

★ The Standard offering represents the most common options. The starred options (★) should be selected for best delivery lead time. The Expanded offering is subject to additional delivery lead time

Immersion length (U)			
0345	345 mm		★
0400	400 mm		★
XXXX	Non-standard immersion length (available from 50 to 2500 mm in 5 mm increments)		
	Thermowell mounting style	Process connections	Stem style
G02 ⁽²⁾	Threaded, tapered	R 1/2-in. (1/2-in. BSPT)	Stepped, NAMUR
G04 ⁽²⁾	Threaded, tapered	R 3/4-in. (3/4-in. BSPT)	Stepped, NAMUR
G06 ⁽²⁾	Threaded, tapered	R 1-in. (1-in. BSPT)	Stepped, NAMUR
G13 ⁽²⁾	Threaded, parallel	M27 × 2	Stepped, NAMUR
G20 ⁽²⁾	Threaded, parallel	G 1/2-in. (1/2-in. BSPF)	Stepped, NAMUR
G22 ⁽²⁾	Threaded, parallel	G 3/4-in. (3/4-in. BSPF)	Stepped, NAMUR
G24 ⁽²⁾	Threaded, parallel	G 1 -in. (1-in. BSPF)	Stepped, NAMUR
G91 ⁽²⁾	Threaded, parallel	M20 × 1.5	Stepped, NAMUR
G31 ⁽²⁾	Threaded, parallel	M33 × 2	Stepped, NAMUR
G38 ⁽²⁾	Threaded, tapered	1/2-in. NPT	Stepped, NAMUR
G40 ⁽²⁾	Threaded, tapered	3/4-in. NPT	Stepped, NAMUR
G42 ⁽²⁾	Threaded, tapered	1-in. NPT	Stepped, NAMUR
G52 ⁽³⁾	Threaded, parallel	G 1/2-in. (1/2-in. BSPF)	Straight, GN, D. 9 × 1 mm
G92 ⁽³⁾	Threaded, parallel	M20 × 1.5	Straight, GN, D. 9 × 1 mm
G63 ⁽³⁾	Threaded, parallel	G 1/2-in. (1/2-in. BSPF)	Straight, GN, D. 11 × 2 mm
G94 ⁽³⁾	Threaded, parallel	M20 × 1.5	Straight, GN, D. 11 × 2 mm
G72 ⁽³⁾	Threaded, parallel	G 1/2-in. (1/2-in. BSPF)	Straight, GN, D. 9 × 1 mm
G95 ⁽³⁾	Threaded, parallel	M20 × 1.5	Straight, GN, D. 9 × 1 mm
L02 ⁽²⁾	Flanged, RF	1-in. 150 lb	Stepped, NAMUR
L08 ⁽²⁾	Flanged, RF	1 1/2-in. 150 lb	Stepped, NAMUR
L14 ⁽²⁾	Flanged, RF	2-in. 150 lb	Stepped, NAMUR
L20 ⁽²⁾	Flanged, RF	1-in. 300 lb	Stepped, NAMUR
L26 ⁽²⁾	Flanged, RF	1 1/2-in. 300 lb	Stepped, NAMUR
L32 ⁽²⁾	Flanged, RF	2-in. 300 lb	Stepped, NAMUR
H02 ⁽²⁾	Flange, Form B1 according to EN 1092-1	DN 25 PN 16	Stepped, NAMUR
H08 ⁽²⁾	Flange, Form B1 according to EN 1092-1	DN 25 PN 25/40	Stepped, NAMUR
H14 ⁽²⁾	Flange, Form B1 according to EN 1092-1	DN 40 PN 16	Stepped, NAMUR
H20 ⁽²⁾	Flange, Form B1 according to EN 1092-1	DN 40 PN 25/40	Stepped, NAMUR
H26 ⁽²⁾	Flange, Form B1 according to EN 1092-1	DN 50 PN 40	Stepped, NAMUR

Table 2. Series 65 Platinum RTD and 185 Thermocouple With Tubular Thermowell

★ The Standard offering represents the most common options. The starred options (★) should be selected for best delivery lead time. The Expanded offering is subject to additional delivery lead time

Options (include with selected model number)

Sensor options (available with 65 only)		Temperature range	
A1	Single element class A sensor	-50 to 300 °C (-58 to 572 °F) (0 to 350 °C for sensor types 7, 9, 0)	★
A2	Dual element class A sensor	-50 to 300 °C (-58 to 572 °F) (0 to 350 °C for sensor types 7, 9, 0)	★
Product certifications⁽⁴⁾			
I1	ATEX Intrinsic Safety Approval		★
N1	ATEX Type n Approval		★
E1	ATEX Flameproof Approval		★
ND	ATEX Dust Approval		★
K1	ATEX Flameproof, Intrinsic Safety, Type n, and Dust Approval		★
E7	IECEX Flameproof Approval		★
E5	US Explosionproof Approval		★
E4	TIIS Flameproof Approval (consult factory for availability)		★
E6	Canada Explosionproof Approval		★
E2	Brazil Flameproof Approval		★
KD	US Explosionproof, Canada Explosionproof, and ATEX Explosionproof Approval		★
KM	Technical Regulations Customs Union (EAC) Flameproof, Intrinsic Safety Approval		★
IM	Technical Regulations Customs Union (EAC) Intrinsic Safety Approval		★
EM	Technical Regulations Customs Union (EAC) Flameproof Approval		★
Ground screw			
G1	External ground screw (only available with Rosemount connection head codes C, D, G, H, 1, and 2)		★
Cable glands			
G2	Cable gland, EEx d, brass, diam 7.5–11.9 mm		
G4	Cable gland, M20 × 1.5 EMV, brass nickel coated, diam 9–13 mm		
G5	Cable gland, M20 × 1.5 EMV, brass nickel coated, diam 5–13 mm		
G7	Cable gland, M20 × 1.5, EEx e, blue, polyamide, diam 5–9 mm		
Cover chain option			
G3	Cover chain (only available with Rosemount connection head codes C, D, G, and H)		★
Extension ring			
G6	Aluminum extension ring for dual transmitter mounting (use with Rosemount connection head codes C and D)		★
Material certification			
Q8	Thermowell material certification, DIN EN 10204 3.1		★
External pressure test			
R01	Thermowell external pressure testing		★

Table 2. Series 65 Platinum RTD and 185 Thermocouple With Tubular Thermowell

★ The Standard offering represents the most common options. The starred options (★) should be selected for best delivery lead time. The Expanded offering is subject to additional delivery lead time

Dye test		
R03	Thermowell dye penetration testing	★
Special cleaning		
R04	Thermowell special cleaning	★
Assemble to options ⁽⁵⁾		
XA	Assemble sensor to specific temperature transmitter (PTFE paste)	★
Sensor calibration with works certificate (available with 65 only)		
V10	Sensor calibration from -50 to 450 °C (-58 to 842 °F) with A, B, C, and Callendar-Van Dusen constants	★
V11	Sensor calibration from 0 to 100 °C (32 to 212 °F) with A, B, C, and Callendar-Van Dusen constants	★
X8	Sensor calibration over specified temperature range with A, B, C, and Callendar-Van Dusen constants	★
Temperature range option		
LT	Special material to meet extended temperature range of -51 °C (-60 °F)	★
Typical model number: 0065 G 2 2 D 0135 D 0225 F70 Q8 R01 R07		

1. To maintain IP rating, use a suitable cable gland on the conduit connection thread. All threads must be sealed with a suitable sealing tape.
2. The NAMUR stepped profile is available in both thermowell material options, however to maintain NAMUR compliance material code Y is required. 115 mm is the minimum immersion length stepped thermowells are available and is the minimum requirement to maintain NAMUR compliance however for lengths shorter than 115 mm a straight thermowell with a 8 mm OD will be provided.
3. Not available with thermowell Material code D.
4. Refer to [Table 7 on page 29](#) for limitation on options available with approvals.
5. If ordering Assemble To option XA with a transmitter, specify the same option on the transmitter model number.

Specification and selection of product materials, options, or components must be made by the purchaser of the equipment. See page 25 for more information on material selection.

Table 3. Series 65 Platinum RTD and 185 Thermocouple With Barstock Thermowell

★ The Standard offering represents the most common options. The starred options (★) should be selected for best delivery lead time. The Expanded offering is subject to additional delivery lead time.

Model	Product description			
0065	Pt 100 RTD (IEC 751) with barstock thermowell			
0185	Thermocouples (IEC 584 Class 1) with barstock thermowell			
Connection head		IP rating ⁽¹⁾	Conduit/cable entry	
C	Rosemount aluminum	66/68	M20 × 1.5	★
D	Rosemount aluminum	66/68	1/2-in. NPT	★
1	Rosemount aluminum with LCD display meter cover	66/68	M20 × 1.5	★
2	Rosemount aluminum with LCD display meter cover	66/68	1/2-in. NPT	★
N	No connection head	N/A	N/A	★
G	Rosemount stainless steel	66/68	M20 × 1.5	
H	Rosemount stainless steel	66/68	1/2-in. NPT	
J	GR-A/BL (BUZ) aluminum w/ cable gland	65	M20 × 1.5	
L	TZ-A/BL (BUZH) aluminum w/ cable gland	65	M20 × 1.5	
7	Aluminum dual entry head	66	2 × 3/4-in. NPT	
8	Aluminum dual entry head	66	2 × M20 × 1.5	
9	Aluminum dual entry head	66	2 × 1/2-in. NPT	
K	Stainless steel dual entry head	66	2 × 3/4-in. NPT	
R	Stainless steel dual entry head	66	2 × M20 × 1.5	
W	Stainless steel dual entry head	66	2 × 1/2-in. NPT	
A	TZ-A/BL (BUZH) aluminum coated	65	M20 × 1.5	
P	SD-BK	N/A	M20 × 1.5	
Sensor lead wire termination				
0	Flying leads (no springs on DIN plate)			★
2	Terminal block (DIN 43762)			★
3	Spring loaded adapter (1/2-in. NPT)			★
Sensor type			Temperature range	
65 Only	1	RTD, single element, 4-wire	-50 to 450 °C (-58 to 842 °F)	★
	2	RTD, dual element, 3-wire	-50 to 450 °C (-58 to 842 °F)	★
	3	RTD, single element, 4-wire	-196 to 300 °C (-321 to 572 °F)	★
	4	RTD, dual element, 3-wire	-196 to 300 °C (-321 to 572 °F)	★
185 Only	03J1	Thermocouple, Type J, single element, ungrounded	-40 to 750 °C (-40 to 1382 °F)	★
	03K1	Thermocouple, Type K, single element, ungrounded	-40 to 1000 °C (-40 to 1832 °F)	★
	05J1	Thermocouple, Type J, dual element, isolated, ungrounded	-40 to 750 °C (-40 to 1382 °F)	★
	05K1	Thermocouple, Type K, dual element, isolated, ungrounded	-40 to 1000 °C (-40 to 1832 °F)	★

Table 3. Series 65 Platinum RTD and 185 Thermocouple With Barstock Thermowell

★ The Standard offering represents the most common options. The starred options (★) should be selected for best delivery lead time. The Expanded offering is subject to additional delivery lead time.

Sensor type			Temperature range		
65 only	7	RTD, single element, 3 wire vibration resistance	-60 to 600 °C (-76 to 1112 °F)		
	9	RTD, single element, 4 wire vibration resistance	-60 to 600 °C (-76 to 1112 °F)		
	0	RTD, dual element, 3 wire vibration resistance	-60 to 600 °C (-76 to 1112 °F)		
185 only	03N1	Thermocouple, Type N, single element, ungrounded	-40 to 1000 °C (-40 to 1832 °F)		
	05N1	Thermocouple, Type N, dual element, isolated, ungrounded	-40 to 1000 °C (-40 to 1832 °F)		
Extension		Head connection	Instrument connection	Materials	
D	DIN standard 12 × 1.5	M24 × 1.5	1/2-in. NPT	300 SST	★
T	DIN standard 12 × 1.5	M24 × 1.5	M18 × 1.5	300 SST	★
F	Nipple union nipple	1/2-in. NPT	1/2-in. NPT	300 SST	★
J	Nipple union (M/F)	None	1/2-in. NPT	300 SST	★
N	No extension (only available with connection head code N)				★
Extension length (N) in millimeters					
0000	No extension (use with extension code N)				★
0035	35 mm				★
0080	80 mm (standard for extension type code J)				★
0110	110 mm (standard for extension type codes F and J)				★
0135	135 mm (standard for DIN extension used with Rosemount connection head material codes C, D, G, H, 1, and 2)				★
0150	150 mm (standard for DIN extension used with Form B connection head material codes J and L)				★
XXXX	Non-standard extension length (available from 35 to 500 mm in 5 mm increments)				
Thermowell material					
D	1.4404 (316L SST)				★
Y	1.4571 (316Ti SST)				★
A	1.4401 (316 SST)				
J	2.4819 (Alloy C-276)				
K	1.5415 (A 204 Size A)				
P	1.7380 (A 182-Grade F22)				
Z	1.7335 (A 182-Grade F11)				
Immersion length (U)					
0065	65 mm				★
0075	75 mm				★
0115	115 mm				★
0125	125 mm				★
0150	150 mm				★

Table 3. Series 65 Platinum RTD and 185 Thermocouple With Barstock Thermowell

★ The Standard offering represents the most common options. The starred options (★) should be selected for best delivery lead time. The Expanded offering is subject to additional delivery lead time.

0225	225 mm			★
0300	300 mm			★
0450	450 mm			★
XXXX	Non-standard immersion length (available from 50 to 1000 mm in 5 mm increments)			
Code	Thermowell mounting style	Process connections	Stem style	
T08	Threaded	R 1/2-in. (1/2-in. BSPT)	Tapered	★
T10	Threaded	R 3/4-in. (3/4-in. BSPT)	Tapered	★
T12	Threaded	R 1-in. (1-in. BSPT)	Tapered	★
T26 ⁽²⁾	Threaded	G 1/2-in. (1/2-in. BSPF)	Tapered	★
T28 ⁽²⁾	Threaded	G 3/4-in. (3/4-in. BSPF)	Tapered	★
T30 ⁽²⁾	Threaded	G 1-in. (1-in. BSPF)	Tapered	★
T44	Threaded	1/2-in. NPT	Tapered	★
T46	Threaded	3/4-in. NPT	Tapered	★
T48	Threaded	1-in. NPT	Tapered	★
T93 ⁽²⁾	Threaded	M27 × 2	Tapered	★
T95 ⁽²⁾	Threaded	M33 × 2	Tapered	★
T98 ⁽²⁾	Threaded	M20 × 1.5	Tapered	★
F04	Flanged, RF	1-in. 150 lb	Tapered	★
F10	Flanged, RF	1 1/2-in. 150 lb	Tapered	★
F16	Flanged, RF	2-in. 150 lb	Tapered	★
F22	Flanged, RF	1-in. 300 lb	Tapered	★
F28	Flanged, RF	1 1/2-in. 300 lb	Tapered	★
F34	Flanged, RF	2-in. 300 lb	Tapered	★
F40	Flanged, RF	1-in. 600 lb	Tapered	★
F46	Flanged, RF	1 1/2-in. 600 lb	Tapered	★
F52	Flanged, RF	2-in. 600 lb	Tapered	★
F58 ⁽³⁾	Flanged, RF	1-in. 900/1500 lb	Tapered	★
F64 ⁽³⁾	Flanged, RF	1 1/2-in. 900/1500 lb	Tapered	★
F70 ⁽³⁾⁽⁴⁾	Flanged, RF	2-in. 900/1500 lb	Tapered	★
F82 ⁽³⁾⁽⁴⁾	Flanged, RF	1 1/2-in. 2500 lb	Tapered	★
F88 ⁽³⁾⁽⁴⁾	Flanged, RF	2-in. 2500 lb	Tapered	★
D04	Flange, Form B1 according to EN 1092-1	DN 25 PN 16	Tapered	★
D10	Flange, Form B1 according to EN 1092-1	DN 25 PN 25/40	Tapered	★
D16	Flange, Form B1 according to EN 1092-1	DN 40 PN 16	Tapered	★
D22	Flange, Form B1 according to EN 1092-1	DN 40 PN 25/40	Tapered	★

Table 3. Series 65 Platinum RTD and 185 Thermocouple With Barstock Thermowell

★ The Standard offering represents the most common options. The starred options (★) should be selected for best delivery lead time. The Expanded offering is subject to additional delivery lead time.

Code	Thermowell mounting style	Process connections	Stem style	
D28	Flange, Form B1 according to EN 1092-1	DN 50 PN 40	Tapered	★
W10	Welded	3/4-in. pipe	Tapered	★
W12	Welded	1-in. pipe	Tapered	★
W14	Welded	1 1/4-in. pipe	Tapered	★
W16	Welded	1 1/2-in. pipe	Tapered	★
E01 ⁽⁵⁾⁽⁶⁾	D1 welded	24h7	Tapered	★
E02 ⁽⁵⁾⁽⁶⁾	D2 welded	24h7	Tapered	★
E04 ⁽⁵⁾⁽⁷⁾	D4 welded	24h7	Tapered	★
E05 ⁽⁵⁾⁽⁷⁾	D5 welded	24h7	Tapered	★

Options (include with selected model number)

Sensor options (available with 65 only)		Temperature range	
A1	Single element Class A sensor	-50 to 300 °C (-58 to 572 °F) (0 to 350 °C for sensor types 7, 9, 0)	★
A2	Dual element Class A sensor	-50 to 300 °C (-58 to 572 °F) (0 to 350 °C for sensor types 7, 9, 0)	★
Product certifications⁽⁸⁾			
I1	ATEX Intrinsic Safety Approval		★
N1	ATEX Type n Approval		★
E1	ATEX Flameproof Approval		★
ND	ATEX Dust Approval		★
K1	ATEX Flameproof, Intrinsic Safety, Type n, and Dust Approval		★
E7	IECEx Flameproof Approval		★
E5	US Explosionproof Approval		★
E4	TIIS Flameproof Approval (consult factory for availability)		★
E6	Canada Explosionproof Approval		★
E2	Brazil Flameproof Approval		★
KD	USA Explosionproof, Canada Explosionproof, and ATEX Flameproof Approval		★
KM	Technical Regulations Customs Union (EAC) Flameproof, Intrinsic Safety Approval		★
IM	Technical Regulations Customs Union (EAC) Intrinsic Safety Approval		★
EM	Technical Regulations Customs Union (EAC) Flameproof Approval		★
Ground screw			
G1	External ground screw (only available with Rosemount connection head codes C, D, G, H, 1, and 2)		★
Cable glands			
G2	Cable gland, EEx d, brass, diameter 7.5–11.9 mm		
G4	Cable gland, M20 × 1.5 EMV, brass nickel coated, diameter 9–13 mm		

Table 3. Series 65 Platinum RTD and 185 Thermocouple With Barstock Thermowell

★ The Standard offering represents the most common options. The starred options (★) should be selected for best delivery lead time. The Expanded offering is subject to additional delivery lead time.

Cable glands		
G5	Cable gland, M20 × 1.5 EMV, brass nickel coated, diameter 5–13 mm	
G7	Cable gland, M20 × 1.5, EEx e, blue, polyamide, diameter 5–9 mm	
Cover chain option		
G3	Cover chain (only available with Rosemount connection head codes C, D, G, and H)	★
Extension ring		
G6	Aluminum extension ring for dual transmitter mounting (use with Rosemount connection head codes C and D)	★
Termination		
TB	Terminal block for use with sensor termination code 3	★
Material certification		
Q8	Thermowell material certification, DIN EN 10204 3.1	★
External pressure test		
R01	Thermowell external pressure testing	★
Internal pressure test		
R22	Thermowell internal pressure testing	★
Dye test		
R03	Thermowell dye penetration testing	★
Special cleaning		
R04	Thermowell special cleaning	★
NACE® approval⁽⁹⁾		
R05	Thermowell NACE approval	★
Plug/chain		
R06	Stainless steel plug and chain	★
Weld options		
R07	Full penetration weld (for flanged thermowells only)	★
Wake frequency		
R21	Wake frequency (thermowell strength calculation)	★
Assemble to options⁽¹⁰⁾		
XA	Assemble sensor to specific temperature transmitter (PTFE paste)	★
Sensor calibration with works certificate (available with 65 only)		
V10	Sensor calibration from –50 to 450 °C (–58 to 842 °F) with A, B, C, and Callendar-Van Dusen constants	★

Table 3. Series 65 Platinum RTD and 185 Thermocouple With Barstock Thermowell

★ The Standard offering represents the most common options. The starred options (★) should be selected for best delivery lead time. The Expanded offering is subject to additional delivery lead time.

Sensor calibration with works certificate (available with 65 only)		
V11	Sensor calibration from 0 to 100 °C (32 to 212 °F) with A, B, C, and Callendar-Van Dusen constants	★
X8	Sensor calibration over specified temperature range with A, B, C, and Callendar-Van Dusen constants	★
VS system calibration		
MD1	MID custody transfer, -196 to 0 °C (-321 to 32 °F)	★
MD2	MID custody transfer, -50 to 100 °C (-58 to 212 °F)	★
MD3	MID custody transfer, 50 to 200 °C (122 to 392 °F)	★
Temperature range option		
LT	Special material to meet extended temperature range of -51 °C (-60 °F)	★
Typical model number: 0065 G 2 2 D 0135 D 0225 F70 Q8 R01 R07		

1. To maintain IP rating, use a suitable cable gland on the conduit connection thread. All threads must be sealed with a suitable sealing tape.
2. This mounting style is only available with the lagging length code T040.
3. Full penetration weld option R07 is required with this mounting style.
4. This mounting style has a minimum lagging length of 80 mm.
5. Only available with extension style T.
6. This mounting style is only available with the lagging length code T075.
7. This mounting style is only available with the lagging length code T135.
8. Refer to [Table 7 on page 29](#) for limitation on options available with approvals.
9. Only available with thermowell material codes D, J, and A.
10. If ordering Assemble To Option XA with a transmitter, specify the same option on the transmitter model number.

Rosemount Series 96 Barstock Thermowell

The Rosemount Series 96 Barstock Thermowell has designs that provide flexible and reliable temperature measurements in process environments.

Features include:

- Threaded, flanged, and weld-in styles
- Wake frequency calculations conforming to ASME PTC 19.3
- NACE approval available
- Variety of testing and certification options available

Specification and selection of product materials, options, or components must be made by the purchaser of the equipment.

See [page 25](#) for more information on material selection.



Table 4. Series 96 Barstock Thermowell

★ The Standard offering represents the most common options. The starred options (★) should be selected for best delivery lead time. The Expanded offering is subject to additional delivery lead time.

Model	Product description			
0096	Barstock thermowell			
Thermowell material⁽¹⁾				
D	1.4404 (316L SST)	★		
Y	1.4571 (316Ti SST)	★		
A	1.4401 (316 SST)			
J	2.4819 (Alloy C-276)			
K	1.5415 (204 Size A)			
P	1.7380 (182 Grade-F22)			
Z	1.7335 (182 Grade-F11)			
Immersion length (L) in millimeters				
0065	65 mm (standard length for weld-in thermowells, E01 and E04)	★		
0075	75 mm	★		
0115	115 mm	★		
0125	125 mm (standard length for weld-in thermowells, E02 and E05)	★		
0150	150 mm	★		
0225	225 mm	★		
0300	300 mm	★		
0450	450 mm	★		
XXXX	Non-standard immersion length (available from 25 to 1000 mm in 5-mm increments)			
Thermowell mounting style		Process connections	Stem style	
T08	Thread	R 1/2-in. (1/2-in. BSPT)	Tapered	★
T10	Thread	R 3/4-in. (3/4-in. BSPT)	Tapered	★
T12	Thread	R 1-in. (1-in. BSPT)	Tapered	★
T26 ⁽²⁾	Thread	G 1/2-in. (1/2-in. BSPF)	Tapered	★

Table 4. Series 96 Barstock Thermowell

★ The Standard offering represents the most common options. The starred options (★) should be selected for best delivery lead time. The Expanded offering is subject to additional delivery lead time.

T28 ⁽²⁾	Thread	G 3/4-in. (3/4-in.BSPF)	Tapered	★
T30 ⁽²⁾	Thread	G 1-in. (1-in. BSPF)	Tapered	★
T44	Thread	1/2-in. NPT	Tapered	★
T46	Thread	3/4-in. NPT	Tapered	★
T48	Thread	1-in. NPT	Tapered	★
T93 ⁽²⁾	Thread	M27 × 2	Tapered	★
T95 ⁽²⁾	Thread	M33 × 2	Tapered	★
T98 ⁽²⁾	Thread	M20 × 1.5	Tapered	★
F04	Flange, RF	1-in. 150 lb	Tapered	★
F10	Flange, RF	1 1/2-in. 150 lb	Tapered	★
F16	Flange, RF	2-in. 150 lb	Tapered	★
F22	Flange, RF	1-in. 300 lb	Tapered	★
F28	Flange, RF	1 1/2-in. 300 lb	Tapered	★
F34	Flange, RF	2-in. 300 lb	Tapered	★
F40	Flange, RF	1-in. 600 lb	Tapered	★
F46	Flange, RF	1 1/2-in. 600 lb	Tapered	★
F52	Flange, RF	2-in. 600 lb	Tapered	★
F58 ⁽³⁾	Flanged, RF	1-in. 900/1500 lb	Tapered	★
F64 ⁽³⁾	Flanged, RF	1 1/2-in. 900/1500 lb	Tapered	★
F70 ⁽³⁾⁽⁴⁾	Flanged, RF	2-in. 900/1500 lb	Tapered	★
F82 ⁽³⁾⁽⁴⁾	Flanged, RF	1 1/2-in 2500 lb	Tapered	★
F88 ⁽³⁾⁽⁴⁾	Flanged, RF	2-in. 2500 lb	Tapered	★
D04	Flange, Form B1 according to EN 1092-1	DN 25 PN 16	Tapered	★
D10	Flange, Form B1 according to EN 1092-1	DN 25 PN 25/40	Tapered	★
D16	Flange, Form B1 according to EN 1092-1	DN 40 PN 16	Tapered	★
D22	Flange, Form B1 according to EN 1092-1	DN 40 PN 25/40	Tapered	★
D28	Flange, Form B1 according to EN 1092-1	DN 50 PN 40	Tapered	★
W10	Welded	3/4-in. pipe	Tapered	★
W12	Welded	1-in. pipe	Tapered	★
W14	Welded	1 1/4-in. pipe	Tapered	★
W16	Welded	1 1/2-in. pipe	Tapered	★
Thermowell mounting style		Process connections	Stem style	
E01 ⁽⁵⁾	D1 welded, DIN	24h7	Tapered	★
E02 ⁽⁵⁾	D2 welded, DIN	24h7	Tapered	★
E04 ⁽⁶⁾	D4 welded, DIN	24h7	Tapered	★
E05 ⁽⁶⁾	D5 welded, DIN	24h7	Tapered	★

Table 4. Series 96 Barstock Thermowell

★ The Standard offering represents the most common options. The starred options (★) should be selected for best delivery lead time. The Expanded offering is subject to additional delivery lead time.

Lagging length		
T040	40 mm	★
T060	60 mm	★
T075	75 mm	★
T080	80 mm	★
T135	135 mm	★
TXXX	Non standard lagging length	
Instrument connection thread type		
A	M24 × 1.5	★
D	1/2-in. NPT	★
T	M18 × 1.5 (valid for weld-in thermowells codes E01, E02, E04, and E05)	★

Options (include with selected model number)

Material certification		
Q8	Thermowell material certification	★
External pressure test		
R01	Thermowell external pressure testing (flanged thermowells only)	★
Internal pressure test		
R22	Thermowell internal pressure test	★
Dye test		
R03	Thermowell dye penetration testing	★
Special cleaning		
R04	Thermowell special cleaning	★
NACE approval ⁽⁷⁾		
R05	Thermowell NACE approval	★
Plug/chain		
R06	Stainless steel plug and chain	★
Weld options		
R07	Full penetration weld - for flanged thermowells only	★
Flange type		
R16	Ring joint flange face	★

Table 4. Series 96 Barstock Thermowell

★ The Standard offering represents the most common options. The starred options (★) should be selected for best delivery lead time. The Expanded offering is subject to additional delivery lead time.

Wake frequency calculation		
R21	Wake frequency (thermowell strength calculation)	★
Typical model number: 0096 D 0300 F04 T060 D Q8 R01		

1. Additional materials are available upon request.
2. This mounting style is only available with the lagging length code T040.
3. Full penetration weld option R07 is required with this mounting style.
4. This mounting style has a minimum lagging length of 80 mm.
5. This mounting style is only available with the lagging length code T075.
6. This mounting style is only available with the lagging length code T135.
7. Only available with thermowell material codes D, J, and A.

Sensor reference information

Overview

Rosemount integral mount temperature sensors, accessory hardware, and assemblies constitute a complete line of industrial temperature-sensing instruments. A variety of RTD and thermocouple sensors are available alone, or as complete assemblies including connection heads, thermowells, and extension fittings. Emerson offers complete temperature measurement assemblies including Rosemount Smart and Programmable Temperature Transmitters. Ask your Emerson representative for details.

Series 65 Platinum RTD Temperature Sensors are highly linear and have a stable resistance versus temperature relationship. These sensors are used primarily in industrial environments where high accuracy, durability, and long-term stability are required. Series 65 Sensors are designed to meet the most critical parameters of international standards: IEC 751:1983, Amendment 1:1986 and 2:1995 and DIN EN 60751:1996. This standardization provides sensor interchangeability without the need for transmitter circuitry adjustment.

Enhanced performance and optimal temperature measurement accuracy is available for Series 65 Sensors coupled with a range of Rosemount Smart Temperature Transmitters through calibration schedules and Callendar-Van Dusen constants.

Series 185 Thermocouple Temperature Sensors conform to IEC 584:1982, Amendment 1:1989 and are available in types J, K and N. Series 185 Sensors are available single ungrounded, or dual ungrounded, isolated.

All sensors are available in a variety of lengths⁽¹⁾ and ranges with flying lead, terminal block, or 1/2-in. NPT spring-loaded adapter lead wire terminations.

In addition to complete assemblies, Emerson offers a selection of separate accessory hardware including connection heads and thermowells.

Selecting an extension and thermowell

Aside from ambient temperature variations, heat from the process, in a direct mounting configuration, is transferred from the thermowell to the transmitter housing. If the expected process temperature is near or beyond the transmitter specification limits, consider the use of additional thermowell extension length, an extension nipple, or a remote mounting configuration to isolate the transmitter from these excessive temperatures. Figure 1 provides an example of the relationship between transmitter housing temperature rise and extension length. Use Figure 1 and the accompanying example as a guide for determining adequate thermowell extension length.

Figure 1. Transmitter Housing Temperature Rise vs. Uninsulated Extension Length

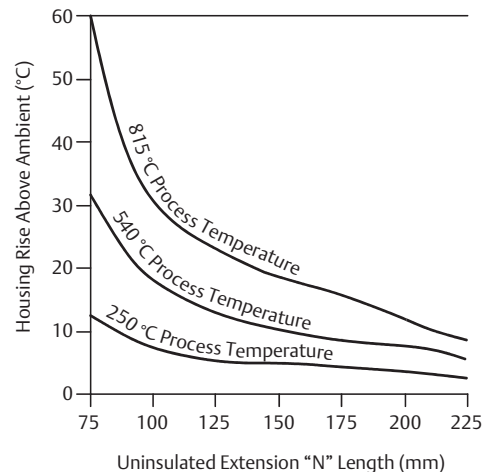

Example

The rated ambient temperature specification for the transmitter is 85 °C. If the maximum ambient temperature is 40 °C and the temperature to be measured is 540 °C, the maximum allowable housing temperature rise is the rated temperature specification limit minus the existing ambient temperature (85 – 40 °F), or 45 °C.

As shown in Figure 1, an "N" dimension of 90 mm will result in a housing temperature rise of 22 °C. An "N" dimension of 100 mm would therefore be the minimum recommended length, and would provide a safety factor of about 25 °C. A longer "N" dimension, such as 150 mm, would be desirable in order to reduce errors caused by transmitter temperature effect, although in that case the transmitter may require extra support.

1. Sensors over one meter long will be supplied coiled unless otherwise requested.

Integral mount sensors and assemblies

Series 65 RTD and Series 185 Thermocouple Temperature Sensors may be ordered as complete assemblies, which provide a complete, yet simple, means of specifying the proper industrial hardware for most temperature measurements. One assembly model number, derived from one ordering table, completely defines the type of sensing element, as well as the material, length, and style of extension fittings and thermowells.

All sensor assemblies are sized and inspected by Emerson to ensure complete component compatibility and performance.

Mounting configurations

Series 65 Platinum RTDs and Series 185 Thermocouples

You may order the Series 65 RTDs and the Series 185 Thermocouples with flying leads, a terminal block, or a 1/2-in. NPT spring-loaded adapter.

Ordered with flying leads, the sensors are designed to be used with a head-mount temperature transmitter attached directly to the sensor. The flying lead configuration allows the removal of the sensor and transmitter as one assembly.

The BUZH connection head allows terminal block style sensors and transmitters to be mounted together. The transmitters in these assemblies will be mounted in the cover of the BUZH connection head.

The sensors with a 1/2-in. NPT spring-loaded adapter are used with directly mounted 3144P field-mount temperature transmitters or through the use of Rosemount connection heads. This assembly requires a terminal block to be mounted inside the head.

Hazardous area approvals are available with all three types of sensors, but they are dependent on the configuration of the entire temperature measurement assembly (see “[Product Certifications](#)” on page 26).

Temperature considerations

Ambient temperature limits for the connection head are -40 °C to +85 °C. The LT Option may be extended down to a range of -51 °C to +85 °C.

Ambient temperature range addresses the connection head only, and requires suitable cable glands and field wiring provisions to meet the temperature requirements below -40 °C.

Figure 2. Series 65 RTD Lead Wire Configuration

Series 65 RTD Flying Leads and spring-loaded adapter-termination codes 0 or 3 only

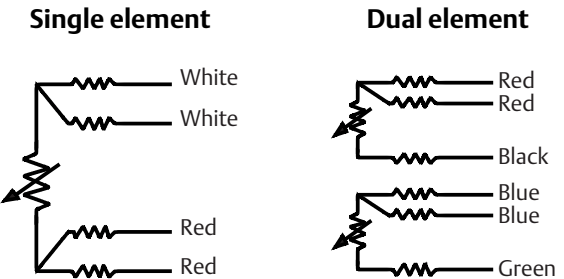

Series 65 RTD Terminal Block termination code 2

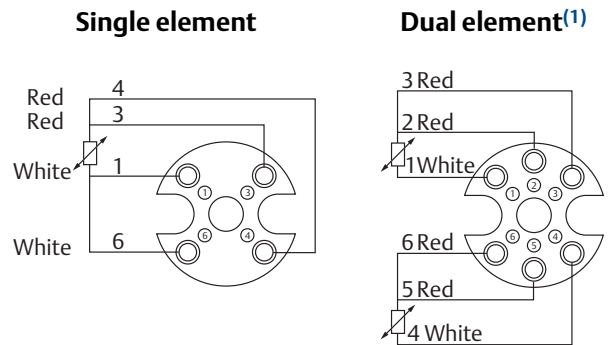

1. The color of the terminal posts in the terminal block may not match the color of the lead wires connected to the capsule.

Figure 3. Series 185 Lead Wire Configuration

Series 185 RTD Thermocouple Terminal Block

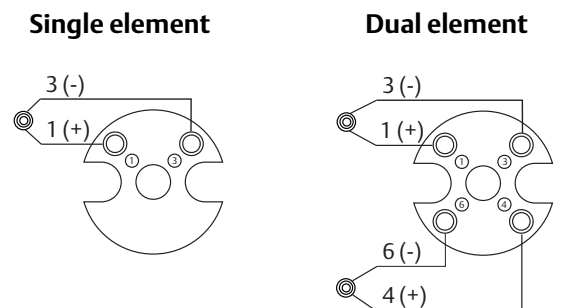

Specifications

Series 65 Platinum RTD

100 Ω RTD at 0 °C,
 $\alpha = 0.00385 \text{ } ^\circ\text{C}^{-1}$

Temperature range

–50 to 450 °C or –196 to 300 °C depending on type

Self heating

0.15 °C/mW when measured per method defined in IEC 751:1983, Amendments 1 and 2

Thermal response time

9 seconds maximum required to reach 50 percent sensor response when tested in flowing water according to IEC 751:1983, Amendments 1 and 2

Immersion error

60 mm minimum usable depth of immersion when tested according to IEC 751:1983, Amendments 1 and 2

Insulation resistance

1,000 M Ω minimum insulation resistance when measured at 500 Vdc and at room temperature

Sheath material

316 SST sensor tip (hot end) with 321SST mineral insulated cable construction

Lead wire

PTFE insulated, silver-coated, 0.21mm² (24 AWG) stranded copper wire. See [Figure 2](#) for wire configuration.

Identification data

The model and serial numbers are marked on each sensor.

Ingress protection (IP) ratings

The Rosemount connection head is rated to IP66/IP68 and NEMA® 4X. The BUZ and BUZH connection heads are rated to IP65. To maintain IP rating at installation, one of the following options must be used with the connection head:

- Extension and/or adapter and barstock thermowell
- Tubular thermowell
- Sensor and sealing screw (extension option “V”)
- General purpose adapter

Vibration limits

For sensor types option code “1”, “2”, “3”, and “4”, the vibration resistance is $\pm 0.02\%$ (0.05 °C) maximum ice-point resistance shift after 3 g vibration between 10 and 500 Hz for 150 hours according to IEC 751:1983, Amendments 1 and 2.

For sensor types option code “7”, “9”, and “0”, the vibration resistance is $\pm 0.02\%$ (0.05 °C) maximum ice-point resistance shift after 10 g vibration between 10 and 500 Hz for 150 hours according to IEC 751:1983, Amendments 1 and 2.

Table 5. Series 65 Interchangeability

Standard series 65 IEC-751 class B	Temperature
$\pm 0.80 \text{ } ^\circ\text{C}$ ($\pm 1.44 \text{ } ^\circ\text{F}$)	–100 °C (–148 °F)
$\pm 0.30 \text{ } ^\circ\text{C}$ ($\pm 0.54 \text{ } ^\circ\text{F}$)	0 °C (32 °F)
$\pm 0.80 \text{ } ^\circ\text{C}$ ($\pm 1.44 \text{ } ^\circ\text{F}$)	100 °C (212 °F)
$\pm 1.80 \text{ } ^\circ\text{C}$ ($\pm 3.24 \text{ } ^\circ\text{F}$)	300 °C (572 °F)
$\pm 2.30 \text{ } ^\circ\text{C}$ ($\pm 4.14 \text{ } ^\circ\text{F}$)	400 °C (752 °F)
Series 65 with IEC-751 class A option	Temperature
$\pm 0.35 \text{ } ^\circ\text{C}$ ($\pm 0.63 \text{ } ^\circ\text{F}$)	–100 °C (–148 °F)
$\pm 0.15 \text{ } ^\circ\text{C}$ ($\pm 0.27 \text{ } ^\circ\text{F}$)	0 °C (32 °F)
$\pm 0.35 \text{ } ^\circ\text{C}$ ($\pm 0.63 \text{ } ^\circ\text{F}$)	100 °C (212 °F)
$\pm 0.75 \text{ } ^\circ\text{C}$ ($\pm 1.35 \text{ } ^\circ\text{F}$)	300 °C (572 °F)

Series 185 Thermocouple

Construction

A thermocouple consists of a junction between two dissimilar metals that produces a change in thermoelectric emf in relationship to a change in temperature. Rosemount Series 185 thermocouple sensors are manufactured from selected materials to meet IEC 584 Tolerance Class 1. The junction of these wires is welded to form a pure joint, maintaining the integrity of the circuit and ensuring the highest accuracy. Ungrounded junctions are protected from the environment by the sensor sheath. The ungrounded and isolated junctions provide electrical isolation from the sensor sheath.

Sheath material

Rosemount thermocouples are made of a mineral insulated cable design with a variety of sheath materials available to suit both the temperature and the environment. For temperatures up to 800 °C in air, 1.4541 (321 SST) is standard. For temperatures from 800 to 1100 °C in air, 2.4816 (Alloy 600) is standard. For temperatures above 1100 °C, precious metal or ceramic protective sheaths are available upon request. For strongly oxidising or reducing atmospheres, consult your local Emerson representative.

Lead wires

PTFE insulated, 0.52 mm² (20 AWG) stranded thermocouple wire. Color coded per IEC 584. See [Figure 3](#) for wire configuration.

Identification data

The model and serial numbers are marked on each sensor.

Insulation resistance

1,000 MΩ minimum insulation resistance when measured at 500 Vdc and at room temperature.

Ingress protection (IP) ratings

The Rosemount connection head is rated to IP66/IP68 and NEMA 4X. The BUZ and BUZH connection heads are rated to IP65. To maintain IP rating at installation, one of the following options must be used with the connection head:

- Extension and/or adapter and barstock thermowell
- Tubular thermowell
- Sensor and sealing screw (Extension option “V”)
- General purpose adapter

Table 6. Characteristics of Series 185 Thermocouples

Type	Alloys (wire color)	Sheath material	Temp. range (°C)	Limits of error (°C) (whichever is greater)	Tolerance class
J	Fe (+ black), CuNi (– white)	1.4541 (321 SST)	–40 to 750	±1.5 or ±0.4%	1
K	NiCr (+ green), NiAl (– white)	2.4816 (Alloy 600)	–40 to 1000	±1.5 or ±0.4%	1
N	NiCrSi (+ pink), NiSi (– white)	2.4816 (Alloy 600)	–40 to 1000	±1.5 or ±0.4%	1

Material selection

Emerson provides a variety of Rosemount product with various product options and configurations including materials of construction that can be expected to perform well in a wide range of applications. The product information presented is intended as a guide for the purchaser to make an appropriate selection for the application. It is the purchaser’s sole responsibility to make a careful analysis of all process parameters (such as all chemical components, temperature, pressure, flow rate, abrasives, contaminants, etc.), when specifying product, materials, options and components for the particular application. Emerson is not in a position to evaluate or guarantee the compatibility of the process fluid or other process parameters with the product, options, configuration or materials of construction selected.

Product Certifications

Rev 1.15

European Directive information

A copy of the EU Declaration of Conformity can be found at the end of the Quick Start Guide. The most recent revision of the EU Declaration of Conformity can be found at Emerson.com/Rosemount.

Ordinary Location Certification

As standard, the transmitter has been examined and tested to determine that the design meets the basic electrical, mechanical, and fire protection requirements by a nationally recognized test laboratory (NRTL) as accredited by the Federal Occupational Safety and Health Administration (OSHA).

North America

The US National Electrical Code® (NEC) and the Canadian Electrical Code (CEC) permit the use of Division marked equipment in Zones and Zone marked equipment in Divisions. The markings must be suitable for the area classification, gas, and temperature class. This information is clearly defined in the respective codes.

Hazardous locations certifications

USA

E5 FM Explosion-proof and Dust-Ignition-proof
 Certificate: FM17US0170X
 Standards: FM Class 3600: 2011; FM Class 3611: 2004; FM Class 3615: 2006; FM Class 3810: 2005; ANSI/NEMA® - 250: 1991
 Markings: XP CL I, Div 1, GP B, C, D; DIP CL II/III, Div 1, GP E, F, G; T5 (-50 °C ≤ T_a ≤ +85 °C); Type 4X

Canada

E6 CSA Explosion-proof and Dust-Ignition-proof
 Certificate: 1063635
 Standards: CSA C22.2 No. 0-M91; CSA C22.2 No. 25-1966; CSA C22.2 No. 30-M1986; CSA C22.2 No. 94-M91; CSA C22.2 No. 142-M1987; CSA C22.2 No. 213-M1987
 Markings: XP CL I, Div 1, GP B, C, D; DIP CL II/III, Div 1, GP E, F, G; CL I, Div 2, GP A, B, C, D; (-50 °C ≤ T_a ≤ +85 °C)

Europe

E1 ATEX Flameproof
 Certificate: FM12ATEX0065X
 Standards: EN60079-0:2012+A11:2013; EN60079-1:2014
 Markings: Ⓔ II 2 G Ex d IIC T6...T1 Gb, T6(-50 °C ≤ T_a ≤ +40 °C), T5...T1 (-50 °C ≤ T_a ≤ +60 °C)

Special Conditions for Safe Use (X):

1. See certificate for ambient temperature range.
2. The non-metallic label may store an electrostatic charge and become a source of ignition in Group III environments.
3. Guard the LCD display cover against impact energies greater than 4 joules.
4. Flameproof joints are not intended for repair.
5. A suitable certified Ex d or Ex tb enclosure is required to be connected to temperature probes with Enclosure option "N".
6. Care shall be taken by the end user to ensure that the external surface temperature on the equipment and the neck of DIN Style Sensor probe does not exceed 130 °C.
7. Non-Standard Paint options may cause risk from electrostatic discharge. Avoid installations that cause electrostatic build-up on painted surfaces, and only clean the painted surfaces with a damp cloth. If paint is ordered through a special option code, contact the manufacturer for more information.

I1 ATEX Intrinsic Safety
 Certificate: Baseefa16ATEX0101X
 Standards: EN 60079-0:2012+A11:2013, EN 60079-11:2012
 Markings: Ⓔ II 1 G Ex ia IIC T5/T6 Ga (see certificate for schedule)

Thermocouples; P _i = 500 mW	T6 60 °C ≤ T _a ≤ +70 °C
RTDs; P _i = 192 mW	T6 60 °C ≤ T _a ≤ +70 °C
RTDs; P _i = 290 mW	T6 60 °C ≤ T _a ≤ +60 °C
	T5 60 °C ≤ T _a ≤ +70 °C

Special Condition for Safe Use (X):

1. The equipment must be installed in an enclosure which affords it a degree of ingress protection of at least IP20.

N1 ATEX Type n
 Certificate: BAS00ATEX3145
 Standards: EN 60079-0:2012, EN 60079-15:2010
 Markings: Ⓔ II 3 G Ex nA IIC T5 Gc (-40 °C ≤ T_a ≤ +70 °C)

ND ATEX Dust

Certificate: FM12ATEX0065X

Standards: EN 60079-0:2012+A11:2013; EN 60079-31:2014

Markings:  II 2 D Ex tb IIIC T130 °C Db ($-40\text{ °C} \leq T_a \leq +70\text{ °C}$)**Special Conditions for Safe Use (X):**

1. See certificate for ambient temperature range.
2. The non-metallic label may store an electrostatic charge and become a source of ignition in Group III environments.
3. Guard the LCD display cover against impact energies greater than 4 joules.
4. Flameproof joints are not intended for repair.
5. A suitable certified Ex d or Ex tb enclosure is required to be connected to temperature probes with Enclosure option "N".
6. Care shall be taken by the end user to ensure that the external surface temperature on the equipment and the neck of DIN Style Sensor probe does not exceed 130 °C.
7. Non-Standard Paint options may cause risk from electrostatic discharge. Avoid installations that cause electrostatic build-up on painted surfaces, and only clean the painted surfaces with a damp cloth. If paint is ordered through a special option code, contact the manufacturer for more information.

International**E7** IECEx Flameproof

Certificate: IECEx FMG 12.0022X

Standards: IEC60079-0:2011, IEC60079-1:2014-06

Markings: Ex d IIC T6...T1 Gb, T6 ($-50\text{ °C} \leq T_a \leq +40\text{ °C}$), T5...T1 ($-50\text{ °C} \leq T_a \leq +60\text{ °C}$)**Special Conditions for Safe Use (X):**

1. See certificate for ambient temperature range.
2. The non-metallic label may store an electrostatic charge and become a source of ignition in Group III environments.
3. Guard the LCD display cover against impact energies greater than 4 joules.
4. Flameproof joints are not intended for repair.
5. A suitable certified Ex d or Ex tb enclosure is required to be connected to temperature probes with Enclosure option "N".
6. Care shall be taken by the end user to ensure that the external surface temperature on the equipment and the neck of DIN Style Sensor probe does not exceed 130 °C.
7. Non-Standard Paint options may cause risk from electrostatic discharge. Avoid installations that cause electrostatic build-up on painted surfaces, and only clean the painted surfaces with a damp cloth. If paint is ordered through a special option code, contact the manufacturer for more information.

Brazil**E2** INMETRO Flameproof

Certificate: UL-BR 13.0535X

Standards: ABNT NBR IEC 60079-0: 20013; ABNT NBR IEC 60079-1: 2016; ABNT NBR IEC 60079-31:2014

Markings: Ex db IIC T6...T1* Gb T6...T1* ($-50\text{ °C} \leq T_a \leq +40\text{ °C}$), T5...T1* ($-50\text{ °C} \leq T_a \leq +60\text{ °C}$) Ex tb IIIC T130 °C Db ($-40\text{ °C} \leq T_a \leq +70\text{ °C}$)**Special Conditions for Safe Use (X):**

1. See product description for ambient temperature limits and process temperature limits.
2. The non-metallic label may store an electrostatic charge and become a source of ignition in Group III environments.
3. Guard the LCD display cover against impact energies greater than 4 joules.
4. Consult the manufacturer if dimensional information on the flameproof joints is necessary.
5. A suitable certified Ex d or Ex tb enclosure is required to be connected to temperature probes with Enclosure option "N".
6. Care shall be taken by the end user to ensure that the external surface temperature on the equipment and the neck of DIN Style Sensor probe does not exceed 130 °C.

Japan**E4** Japan Flameproof (0065 only)

Certificate: TC17226

Markings: Ex d IIC T6; ($-20\text{ °C} \leq T_a \leq +65\text{ °C}$); Process Temperature: -20 °C to $+85\text{ °C}$ **Special Condition for Safe Use (X):**

1. The wiring shall be suitable for a temperature over 80 °C.

EAC – Belarus, Kazakhstan, Russia**EM** Technical Regulation Customs Union (EAC) Flameproof

Markings: 1Ex d IIC T6...T1 Gb X

Special Condition for Safe Use (X):

1. See certificate for special conditions.

IM Technical Regulation Customs Union (EAC) Intrinsic Safety

Markings: 0Ex ia IIC T5, T6 Ga X

Special Condition for Safe Use (X):

1. See certificate for special conditions.

KM Technical Regulation Customs Union (EAC) Intrinsic Safety

Markings: Ex tb IIIC T 130 °C Db X plus EM and IM markings above

Special Condition for Safe Use (X):

1. See certificate for special conditions.

Korea

EP Korea Explosionproof/Flameproof
Certificate: 13-KB4BO-0560X
Markings: Ex d IIC T6...T1; T6($-50\text{ °C} \leq T_{\text{amb}} \leq +40\text{ °C}$),
T5...T1($-50\text{ °C} \leq T_{\text{amb}} \leq +60\text{ °C}$)

Special Condition for Safe Use (X):

1. See certificate.

Combinations

KD Combination of E1, E5, and E6
K1 Combination of E1, I1, N1, and ND
KM Combination of EM and IM

Table 7. Available Safety Approvals with Model Code Options

Model code	Description	Conduit entry	Approval code										
			I1	N1	E1	E2	ND	E7	E5	E4	E6	KD	
C	Rosemount aluminum	M20 × 1.5	Y	Y	Y	Y	Y	Y	Y	Y	N	N	N
D	Rosemount aluminum	1/2-in. NPT	Y	Y	Y	Y	Y	Y	Y	Y	Y	Y	Y
1	Rosemount aluminum with LCD display meter cover	M20 × 1.5	Y	Y	Y	Y	Y	Y	Y	Y	N	N	N
2	Rosemount aluminum with LCD display meter cover	1/2-in. NPT	Y	Y	Y	Y	Y	Y	Y	Y	N	Y	Y
N	No connection head	N/A	Y	Y	Y	Y	Y	Y	Y	Y	N	Y	Y
G	Rosemount stainless steel	M20 × 1.5	Y	Y	Y	Y	Y	Y	Y	Y	N	N	N
H	Rosemount stainless steel	1/2-in. NPT	Y	Y	Y	Y	Y	Y	Y	Y	N	Y	Y
J	GR-A/BL (BUZ) aluminum with cable gland	M20 × 1.5	Y	N	N	N	N	N	N	N	N	N	N
L	BL (BUZH) aluminum with cable gland	M20 × 1.5	Y	N	N	N	N	N	N	N	N	N	N
7	Aluminum dual entry head	2 × 3/4-in. NPT	Y	N	Y	N	N	N	N	N	N	N	N
8	Aluminum dual entry head	2 × M20 × 1.5	Y	N	Y	N	N	N	N	N	N	N	N
9	Aluminum dual entry head	2 × 1/2-in. NPT	Y	N	Y	N	N	N	N	N	N	N	N
K	Stainless steel dual entry head	2 × 3/4-in. NPT	Y	N	Y	N	N	N	N	N	N	N	N
R	Stainless steel dual entry head	2 × M20 × 1.5	Y	N	Y	N	N	N	N	N	N	N	N
W	Stainless steel dual entry head	2 × 1/2-in. NPT	Y	N	Y	N	N	N	N	N	N	N	N
A	TZ-A/BL (BUZH) aluminum coated	M20 × 1.5	Y	N	N	N	N	N	N	N	N	N	N
P	SD-BK	M20 × 1.5	Y	N	N	N	N	N	N	N	N	N	N
Z	ZW-BL	M20 × 1.5	Y	N	N	N	N	N	N	N	N	N	N
G1	External ground screw	N/A	Y	N	Y	N	N	N	Y	N	Y	N	N
G6	Aluminum extension ring for dual transmitter mounting	N/A	Y	N	Y	N	N	N	N	N	N	N	N

Note

Refer to [Table 7](#) to determine which approvals are available with each connection head option code.

Sensor-to-Transmitter Matching

Significant measurement accuracy improvements can be attained using a temperature sensor that is matched to a temperature transmitter. This process involves identifying the relationship between resistance and temperature for a specific RTD sensor. This relationship, approximated by the Callendar-Van Dusen equation, is described as:

$$R_t = R_0 + R_0\alpha[t - \delta(0.01t - 1)(0.01t) - \beta(0.01t - 1)(0.01t)^3],$$

where:

R_t = Resistance (ohms) at Temperature t ($^{\circ}\text{C}$)

R_0 = Sensor-Specific Constant (Resistance at $t = 0^{\circ}\text{C}$)

α = Sensor-Specific Constant

δ = Sensor-Specific Constant

β = Sensor-Specific Constant (0 at $t > 0^{\circ}\text{C}$)

The exact values for the Callendar-Van Dusen constants (R_0 , α , δ , β) are specific to each RTD sensor and are established by testing each individual sensor at various temperatures.

Series 65 RTD sensors can be ordered with the Calibration Option codes V10 or V11, where the values of all four sensor-specific constants are supplied with each sensor.

The transmitter uses the Callendar-Van Dusen constants to generate a sensor curve that describes the relationship between resistance and temperature for this particular sensor and transmitter assembly. By using the sensors actual resistance vs. temperature curve, there is a 3- or 4-fold improvement in temperature measurement accuracy for the total system.

Options V10 and V11 are specific to a particular temperature range. As with calibration schedules, the accuracies associated with each option code represent worst-case conditions when the sensor is used over the entire temperature range. The accuracy of Series 65 sensors with the “V” option will vary because they have different hysteresis and repeatability characteristics. To ensure optimal performance, select a “V” option where the sensor’s range of actual operation is between the minimum and maximum calibration points. For applications requiring the use of a Resistance vs. Temperature Table, order a temperature range-specific characterization schedule.

IEC 751 interpretation

The Callendar-Van Dusen equation is one method of describing the resistance versus temperature (R vs. T) relationship for platinum RTDs. International standard IEC 751 interprets the R vs. T relationship using an approach similar to the Callendar-Van Dusen methodology. The IEC 751 R vs. T relationship standard uses the following equation:

$$R_t = R_0[1 + At + Bt^2 + C(t - 100)t^3]$$

As in the Callendar-Van Dusen method, R_0 , A, B, C are specific to each RTD and are established by testing each sensor at various temperatures. The actual values for A, B, and C differ in magnitude from the Callendar-Van Dusen constants (R_0 , α , β , δ), while R_0 is the same in both equations. Either methodology yields the same result in any sensor-to-transmitter matching scenario, since one equation is a simple mathematical interpretation of the other.

Typical sensor-to-transmitter matching accuracy improvements

Transmitter: Rosemount 3144P (has built-in sensor matching capabilities), span of 0 to 200 °C, accuracy = 0.1 °C)

Sensor: Series 65 RTD

Callendar-Van Dusen option: V10

Process temperature: 150 °C

Figure 4. System Uncertainty Comparison at 150 °C

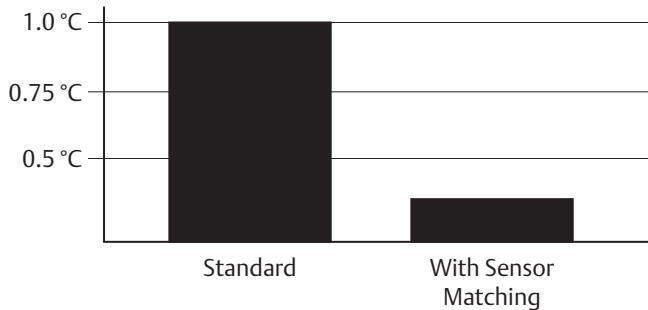

Standard 65 Sensor	
Rosemount 3144P:	± 0.10 °C
Standard series 65 RTD:	± 1.05 °C
Total system ⁽¹⁾ :	± 1.05 °C
65 Sensor with V10 Option	
Rosemount 3144P:	± 0.10 °C
Calibrated sensor series 65 RTD:	± 0.18 °C
Total system ⁽¹⁾ :	± 0.21 °C

1. Calculated using RSS statistical method: System accuracy = $\sqrt{(\text{TransmitterAccuracy})^2 + (\text{SensorAccuracy})^2}$

Calibration

Sensor calibration may be required for input to quality systems, or for control system enhancement. More frequently, it is used to improve the overall temperature measurement performance by matching the sensor to a temperature transmitter. Sensor matching is available for RTD sensors used with Rosemount Smart transmitters where the inherent stability and repeatability of the RTD technology is well established.

Ordering information

Use the formats presented below to order a calibrated series 65 RTD. If you fail to specify all of the necessary calibration-related information when you place your order, Emerson will contact you for the information and your order may be delayed slightly.

Measurement instrument directive parts certification

The Rosemount 3144P Temperature Transmitter and Rosemount 0065 Temperature Sensor have been certified to meet the European Union measurement instrument directive (MID) for custody transfer metering of liquids and gases.⁽¹⁾ Choosing Rosemount temperature for a MID solution ensures that critical temperature measurement equipment will meet high expectations for unmatched system accuracy and reliability. For more information, contact your local Emerson Representative.

Calibration options

The X8 option calibrates the sensor to a customer-specific temperature range. The Callendar-Van Dusen, and A, B, and C-constants are supplied with a works certificate.

1. Calculated using RSS statistical method: System accuracy = $\sqrt{(\text{TransmitterAccuracy})^2 + (\text{SensorAccuracy})^2}$

Option X8: sensor calibrated to a customer-specified temperature range (see [Temperature range](#))

When you order an RTD with the X8 option, the temperature range the sensor needs to be calibrated must be specified. Take note of the sensor temperature limits as shown below:

Table 8. Typical Model Number

Model	Connection head	Lead wire termination	Sensor type	Extension type
0065	C	2	1	D
Extension length	Thermowell material	Immersion length	Mounting style	Additional options
0135	D	0225	T12	X8

Note

Calibrate from -10 to 120 °C.

Table 9. Option V: Sensor Calibration with Works Certificate

	Code		
	V10	V11	V16
Temperature range (°C)	-50 to +450	0 to +100	-50 to +100
Calibration points (°C)	-50 0 +100 +450	0 +50 +100	-50 0 +50 +100

Figure 5. Sensor Assembly Without Thermowell

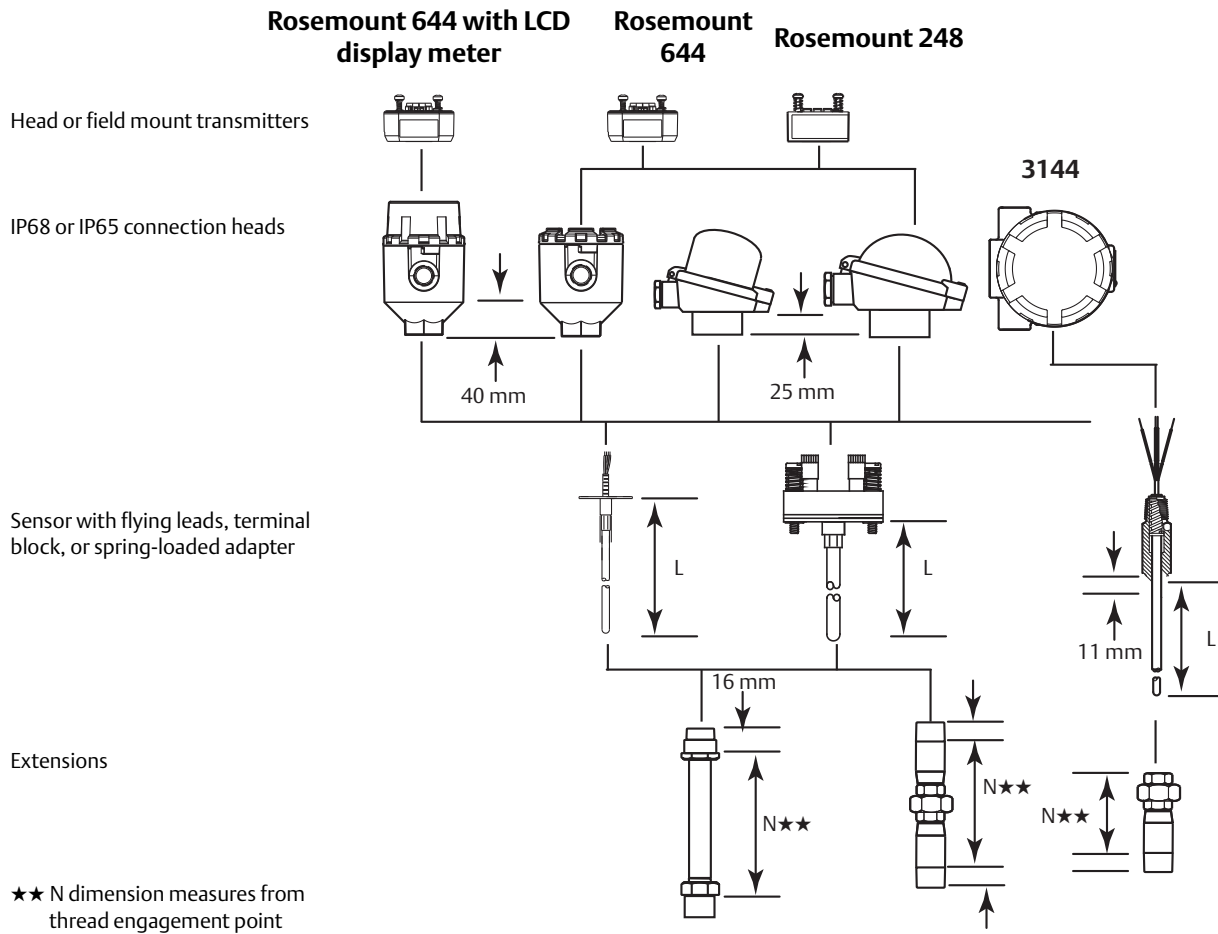
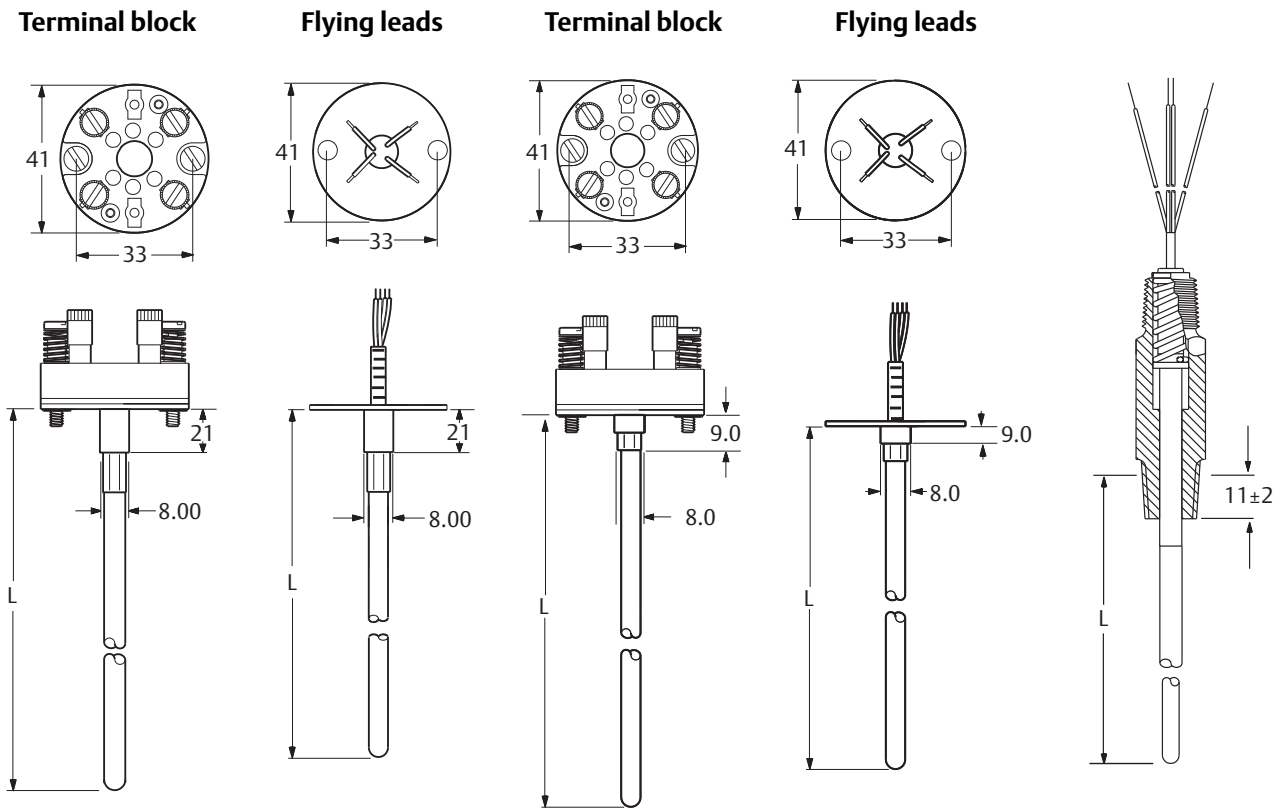

Figure 6. Series 65 RTD and Series 185 Thermocouple Dimensional Drawings

ATEX/CENELEC EEx d flameproof and
IECEX/FM explosion-proof approved

Non-approved

1/2- NPT spring loaded
adapter



Dimensions are in millimeters.

Table 10. Additional Dimensions for Series 65 RTD and Series 185 Thermocouple

Series	Sensor diameter	Number of leads	Lead wire length (flying leads)		Lead wire length (spring loaded)	
			Element 1	Element 2	Element 1	Element 2
65 Single element	6.0	4	150	N/A	150	N/A
65 Dual element	6.0	6	150	200	150	200
185 Single element	6.0	2	100	N/A	150	N/A
185 Dual element	6.0	4	100	200	150	200

Figure 7. Tubular Thermowell Sensor Assemblies

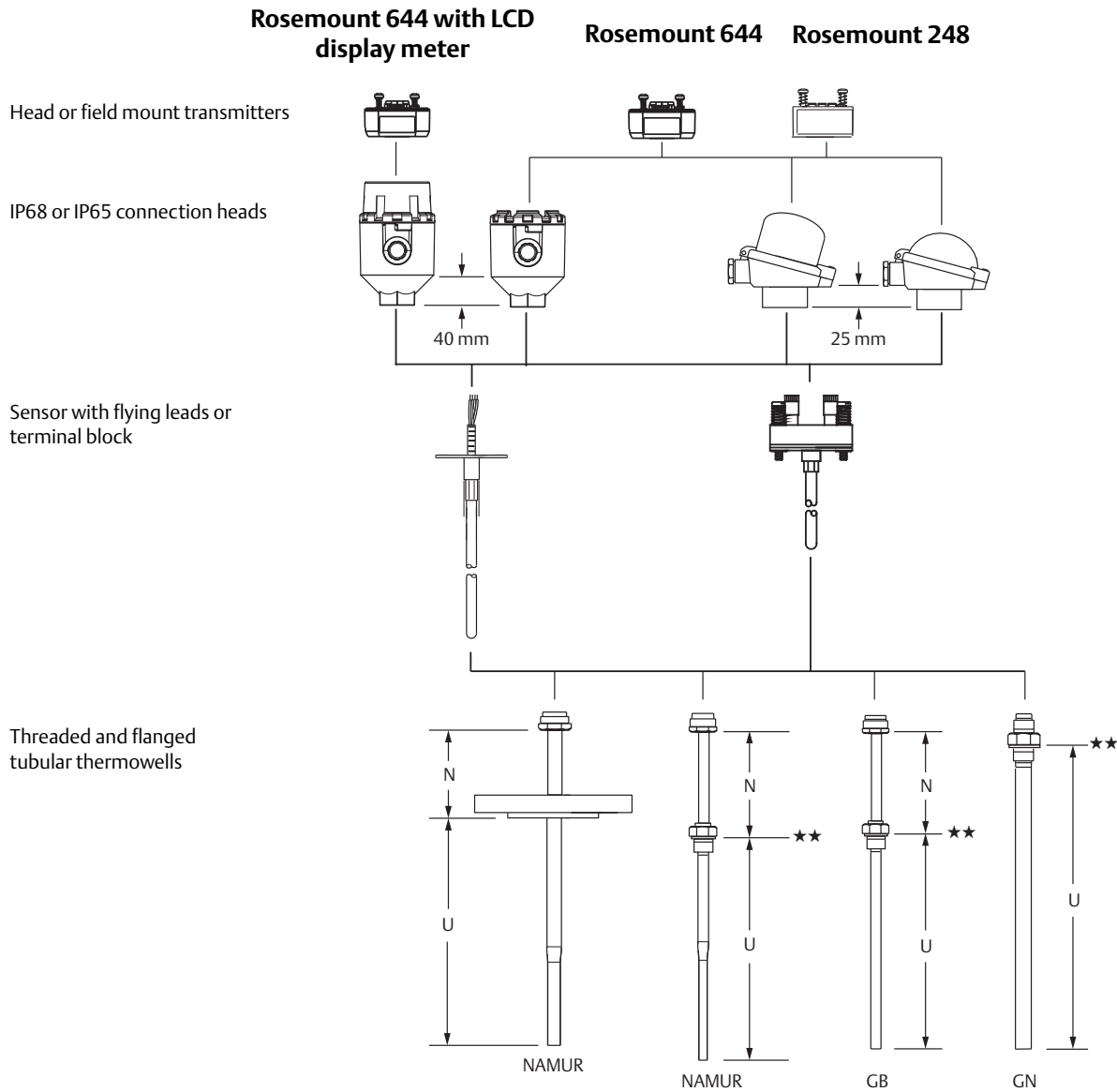

★★ For straight threading, N dimension references bottom of hex.
 For tapered threading, N dimension references thread engagement point (bottom of thread).

Table 11. Tubular Thermowell Ratings

Type	Dimensions	Process connection	Max. flow velocity (m/s)		Immersion length (mm)	Max. pressure (bar)	At temperature (°C)			
			Air	Water			At 0 °C			
							100	200	300	400
GN GB	9 × 1 mm 1.4571 (316 Ti)	Screw socket G ^{1/2}	25	3	160	50	48	44	40	36
					250	40	40	40	40	36
					400	18	18	18	18	18
GN	11 × 2 mm 1.4571 (316 Ti)	Screw socket G1	40	5	160	100	95	92	88	80
					250	50	50	50	50	50
					400	18	18	18	18	18

Table 11. Tubular Thermowell Ratings

Type	Dimensions	Process connection	Max. flow velocity (m/s)		Immersion length (mm)	Max. pressure (bar)	At temperature (°C)			
			Air	Water		At 0 °C	100	200	300	400
NAMUR	12 × 2.5 mm 1.4571 (316 Ti)	Screw socket G1	40	5	160	100	100	100	100	100
					220	100	100	100	78	78
					280	100	100	100	55	55

Figure 8. Barstock Thermowell Sensor Assemblies

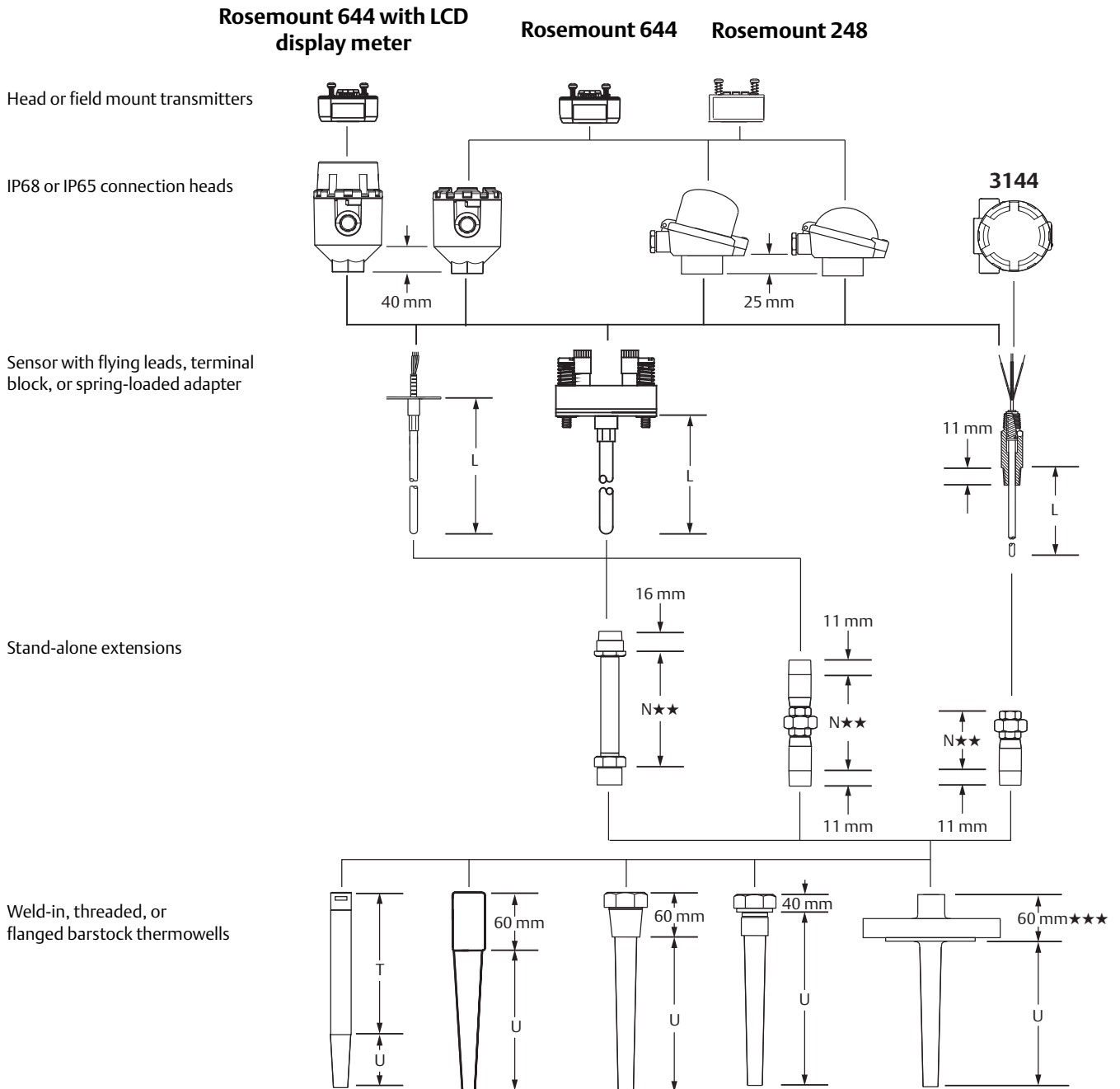

** N dimension measures from thread engagement point.
 *** This dimension is 80 mm for 1500# and 2500# flanges.

Accessories

Table 12. Connection Head

Part number	Model/material	IP rating	Conduit connection	Process connection
00644-4410-0011	Rosemount aluminum	66/68	1/2-in. NPT	1/2-in. NPT
00644-4410-0013	Rosemount aluminum	66/68	1/2-in. NPT	M24 × 1.5
00644-4410-0021	Rosemount aluminum	66/68	M20 × 1.5	1/2-in. NPT
00644-4410-0023	Rosemount aluminum	66/68	M20 × 1.5	M24 × 1.5
00644-4410-0111	Rosemount aluminum with LCD display cover	66/68	1/2-in. NPT	1/2-in. NPT
00644-4410-0113	Rosemount aluminum with LCD display cover	66/68	1/2-in. NPT	M24 × 1.5
00644-4410-0121	Rosemount aluminum with LCD display cover	66/68	M20 × 1.5	1/2-in. NPT
00644-4410-0123	Rosemount aluminum with LCD display cover	66/68	M20 × 1.5	M24 × 1.5
00644-4411-0011	Rosemount stainless steel	66/68	1/2-in. NPT	1/2-in. NPT
00644-4411-0013	Rosemount stainless steel	66/68	1/2-in. NPT	M24 × 1.5
00644-4411-0021	Rosemount stainless steel	66/68	M20 × 1.5	1/2-in. NPT
00644-4411-0023	Rosemount stainless steel	66/68	M20 × 1.5	M24 × 1.5
00644-4196-0023	GR-A/BL (BUZ), aluminum	65	M20 × 1.5	M24 × 1.5
00644-4197-0023	TZ-A/BL (BUZH), aluminum	65	M20 × 1.5	M24 × 1.5

Figure 9. Connection Head Dimensional Drawing

With LCD display cover
Option codes 1, 2

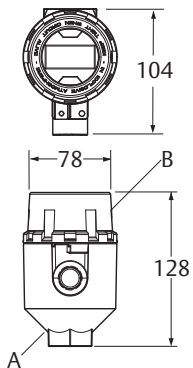

With standard cover
Option codes C, D, G, H

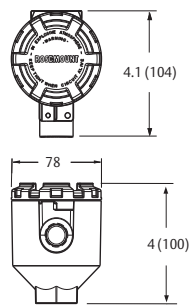

TZ-A/BL (BUZH)
Option code L

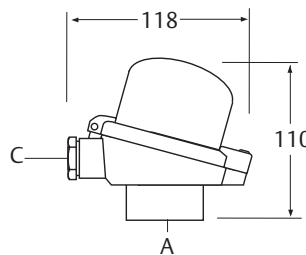

GR-A/BL (BUZ)
Option code J

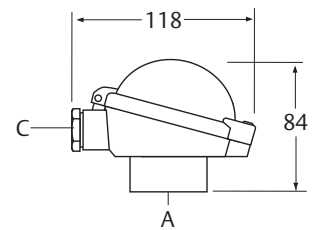

A. Head connection
B. LCD display
C. Cable entry
Dimensions are in millimeters.

Series 96 Barstock Thermowells

Figure 10. Flanged Barstock Thermowell – Tapered

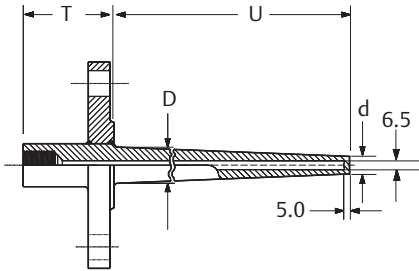

Flange size	D	d	T
1-in. 150–1500 lb, DN 25	19	12.5	60
1½ to 2-in. 150–600 lb, DN40–50	26.5	18	60
1.5 to 2-in. 900/1500	26.5	18	80

U. Immersion length
 D. Stem diameter
 T. Lagging length

Dimensions are in millimeters.

Note: Flanged thermowells generally conform to the specifications of ASME B 16.5 (ANSI) and DIN EN 1092-1.

Figure 11. Threaded Barstock Thermowell – Parallel Thread

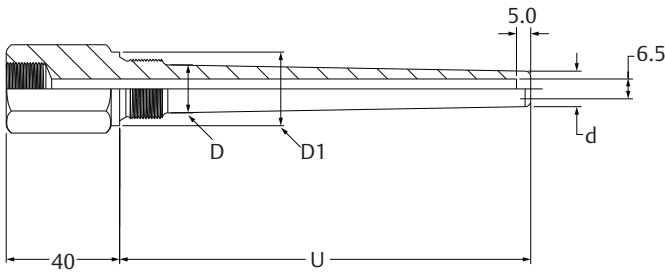

Parallel thread size	D	D1	d
½-in. BSPF (G½); M20 × 1.5	17	26	12.5
¾-in. BSPF (G¾)	19	32	12.5
1-in. BSPF (G1)	26.5	39	18
M24 × 1.5	19	29	12.5

U. Immersion length
 D. Stem diameter

Dimensions are in millimeters.

Figure 12. Threaded Barstock Thermowell – Tapered Thread

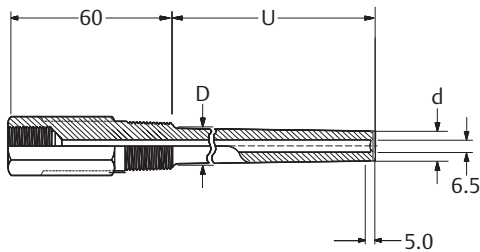

Tapered thread size	D	d
½-in. NPT; M20 × 1.5	17	12.5
¾-in. NPT	19	12.5
1-in. NPT	26.5	18

U. Immersion length
 D. Stem diameter

Dimensions are in millimeters.

Figure 13. Weld-In Barstock Thermowell (Codes W10, W12, W14, W16)

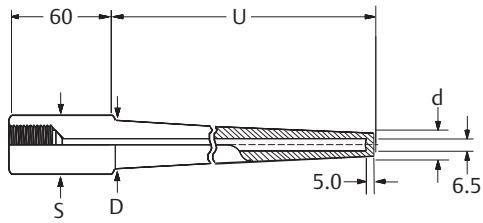

Socket size	S	D	d
3/4-in.	26.7	19.0	12.5
1-in.	33.4	19.0	12.5
1 1/4-in.	42.2	19.0	12.5
1 1/2-in.	48.3	19.0	12.5

U. Immersion length
 D. Stem diameter
 Dimensions are in millimeters.

Figure 14. Weld-in Barstock Thermowell (Codes E01, E02, E04, E05)

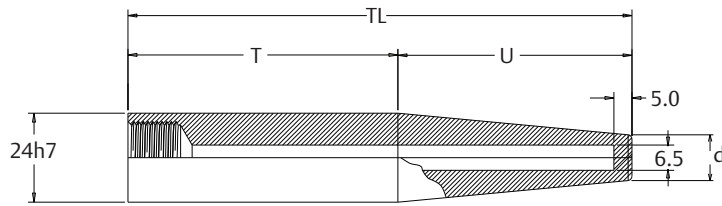

Previous DIN form	D1	D2	D4	D5	d
TL	140	200	200	260	12.5
U	65	125	65	125	12.5
T	75	75	135	135	12.5

U. Immersion length
 TL. Total length
 T. Lagging length
 Dimensions are in millimeters.

Wake frequency calculation

Pressure and flow vibration

The strength of a thermowell depends on several parameters relating thermowell construction to the installation environment. For most industrial applications, standard Rosemount thermowells provide the necessary strength if the material, style, and length are correct for the application. The proper selection of a thermowell depends on fluid type, temperature, pressure, and fluid velocity. Most thermowell failures are caused by vibration that is induced by fluid flow.

Emerson has a design system for the correct selection of thermowells. This selection service is available for a nominal charge, and to take advantage of this service, complete and return the Wake Frequency Calculation Configuration Data Sheet to your local Emerson representative.



Global Headquarters

Emerson Automation Solutions

6021 Innovation Blvd.
Shakopee, MN 55379, USA
 +1 800 999 9307 or +1 952 906 8888
 +1 952 949 7001
 RFQ.RMD-RCC@Emerson.com



North America Regional Office

Emerson Automation Solutions

8200 Market Blvd.
Chanhassen, MN 55317, USA
 +1 800 999 9307 or +1 952 906 8888
 +1 952 949 7001
 RMT-NA.RCCRFQ@Emerson.com

Latin America Regional Office

Emerson Automation Solutions

1300 Concord Terrace, Suite 400
Sunrise, FL 33323, USA
 +1 954 846 5030
 +1 954 846 5121
 RFQ.RMD-RCC@Emerson.com

Europe Regional Office

Emerson Automation Solutions Europe GmbH

Neuhofstrasse 19a P.O. Box 1046
CH 6340 Baar
Switzerland
 +41 (0) 41 768 6111
 +41 (0) 41 768 6300
 RFQ.RMD-RCC@Emerson.com

Asia Pacific Regional Office

Emerson Automation Solutions

1 Pandan Crescent
Singapore 128461
 +65 6777 8211
 +65 6777 0947
 Enquiries@AP.Emerson.com

Middle East and Africa Regional Office

Emerson Automation Solutions

Emerson FZE P.O. Box 17033
Jebel Ali Free Zone - South 2
Dubai, United Arab Emirates
 +971 4 8118100
 +971 4 8865465
 RFQ.RMTMEA@Emerson.com

 [Linkedin.com/company/Emerson-Automation-Solutions](https://www.linkedin.com/company/Emerson-Automation-Solutions)

 [Twitter.com/Rosemount_News](https://twitter.com/Rosemount_News)

 [Facebook.com/Rosemount](https://www.facebook.com/Rosemount)

 [Youtube.com/user/RosemountMeasurement](https://www.youtube.com/user/RosemountMeasurement)

 [Google.com/+RosemountMeasurement](https://www.google.com/+RosemountMeasurement)

Emerson Terms and Conditions of Sale are available upon request.
The Emerson logo is a trademark and service mark of Emerson Electric Co.
Rosemount is a mark of one of the Emerson family of companies. All other
marks are the property of their respective owners.
© 2019 Emerson. All rights reserved.